

# Dell PowerEdge R7615

## Installation and Service Manual

## Notes, cautions, and warnings

 **NOTE:** A NOTE indicates important information that helps you make better use of your product.

 **CAUTION:** A CAUTION indicates either potential damage to hardware or loss of data and tells you how to avoid the problem.

 **WARNING:** A WARNING indicates a potential for property damage, personal injury, or death.

<b>Chapter 1: About this document</b> .....	<b>8</b>
<b>Chapter 2: System overview</b> .....	<b>9</b>
Front view of the system.....	9
Rear view of the system.....	12
Inside the system.....	17
Locating the Express Service Code and Service Tag.....	19
System information label.....	20
Rail sizing and rack compatibility matrix.....	24
<b>Chapter 3: Technical specifications</b> .....	<b>25</b>
Chassis dimensions .....	26
System weight.....	26
PSU specifications.....	27
Processor specifications.....	28
Supported operating systems.....	28
Cooling fan specifications.....	28
System battery specifications.....	29
Expansion card riser specifications.....	29
Memory specifications.....	30
Storage controller specifications.....	31
GPU specifications.....	31
Drives.....	31
Ports and connectors specifications.....	32
USB ports specifications.....	32
NIC port specifications.....	32
Serial connector specifications.....	32
VGA ports specifications.....	32
Video specifications.....	32
Environmental specifications.....	33
Thermal restriction matrix.....	35
Thermal air restrictions.....	41
<b>Chapter 4: Initial system setup and configuration</b> .....	<b>43</b>
Setting up the system.....	43
iDRAC configuration.....	43
Options to set up iDRAC IP address.....	43
Options to log in to iDRAC.....	43
Options to download drivers and firmware .....	44
Resources to install operating system.....	44
<b>Chapter 5: Pre-operating system management applications</b> .....	<b>45</b>
System Setup.....	45
System BIOS.....	46

iDRAC Settings utility.....	62
Device Settings.....	62
Dell Lifecycle Controller.....	62
Embedded system management.....	62
Boot Manager.....	62
PXE boot.....	63

**Chapter 6: Minimum to POST and system management configuration validation..... 64**

Minimum configuration to POST .....	64
Configuration validation.....	64
Error messages.....	65

**Chapter 7: Installing and removing system components..... 66**

Safety instructions.....	66
Before working inside your system.....	67
After working inside your system.....	67
Recommended tools.....	67
Optional front bezel.....	68
Removing the front bezel.....	68
Installing the front bezel.....	69
System cover.....	69
Removing the system cover.....	69
Installing the system cover.....	70
Drive backplane cover.....	71
Removing the drive backplane cover.....	71
Installing the drive backplane cover.....	72
Air shroud.....	74
Removing the air shroud.....	74
Installing the air shroud.....	74
Removing the GPU air shroud top cover.....	75
Installing the GPU air shroud top cover.....	76
Removing the GPU air shroud filler.....	77
Installing the GPU air shroud filler.....	78
Removing the GPU air shroud.....	79
Installing the GPU air shroud.....	80
Removing the 2 x 2.5-inch rear drive module air shroud.....	81
Installing the 2 x 2.5-inch rear drive module air shroud.....	82
Removing the 4 x 2.5-inch rear drive module air shroud.....	83
Installing the 4 x 2.5-inch rear drive module air shroud.....	84
Cooling fan.....	85
Removing the cooling fan cage assembly .....	85
Installing the cooling fan cage assembly.....	86
Removing a cooling fan.....	87
Installing a cooling fan.....	88
Removing a 2 x 2.5-inch rear drive module cooling fan.....	89
Installing a 2 x 2.5-inch rear drive module cooling fan.....	90
Removing a 4 x 2.5-inch rear drive module cooling fan.....	91
Installing a 4 x 2.5-inch rear drive module cooling fan.....	92
Drives.....	93

Removing a drive blank.....	93
Installing a drive blank.....	94
Removing a drive carrier.....	94
Installing the drive carrier.....	95
Removing the drive from the drive carrier.....	96
Installing the drive into the drive carrier.....	97
Rear drive module.....	98
Removing the 2 x 2.5-inch rear drive module.....	98
Installing the 2 x 2.5-inch rear drive module.....	99
Removing the 4 x 2.5-inch rear drive module.....	100
Installing the 4 x 2.5-inch rear drive module.....	102
Drive backplane.....	103
Drive backplane.....	103
Removing the drive backplane .....	105
Installing the drive backplane.....	106
Side wall brackets.....	108
Removing the side wall bracket.....	108
Installing the side wall bracket.....	109
Cable routing.....	110
PERC module.....	136
Removing the rear mounting front PERC module.....	136
Installing the rear mounting front PERC module.....	137
Removing the front mounting front PERC module.....	138
Installing the front mounting front PERC module.....	139
Removing the adapter PERC module.....	140
Installing the adapter PERC module.....	142
Rear drive cage.....	143
Removing the rear drive cage.....	143
Installing the rear drive cage.....	144
System memory.....	145
System memory guidelines.....	145
General memory module installation guidelines.....	147
Removing a memory module.....	147
Installing a memory module.....	148
Processor and heat sink.....	149
Removing a heat sink.....	149
Removing the liquid cooling heat sink modules.....	150
Removing the processor.....	151
Installing the processor.....	153
Installing the heat sink.....	155
Installing the liquid cooling heat sink.....	157
Expansion cards and expansion card risers.....	158
Expansion card installation guidelines.....	159
Removing the expansion card risers.....	199
Installing the expansion card risers.....	203
Removing expansion card from the expansion card riser.....	208
Installing an expansion card into the expansion card riser.....	209
Removing the full length expansion card risers.....	211
Installing the full length expansion card risers.....	213
Removing a GPU.....	216

Installing a GPU.....	218
Optional serial COM port.....	221
Removing the serial COM port.....	221
Installing the serial COM port.....	222
Optional VGA port for Direct Liquid Cooling module.....	224
Removing the VGA port.....	224
Installing the VGA port.....	225
Optional BOSS-N1 module.....	227
Removing the BOSS-N1 module blank.....	227
Installing the BOSS-N1 module blank.....	227
Removing the BOSS-N1 card carrier blank.....	228
Installing the BOSS-N1 card carrier blank.....	229
Removing the BOSS-N1 module.....	229
Installing the BOSS-N1 module.....	231
System battery .....	233
Replacing the system battery.....	233
Optional internal USB card.....	235
Removing the internal USB card.....	235
Installing the internal USB card.....	236
Intrusion switch module.....	237
Removing the intrusion switch.....	237
Installing the intrusion switch.....	237
Optional OCP card.....	238
Removing the OCP card shroud.....	238
Installing the OCP card shroud.....	239
Removing the OCP card.....	240
Installing the OCP card.....	242
Power supply unit.....	243
Hot spare feature.....	243
Removing a power supply unit blank.....	244
Installing a power supply unit blank.....	244
Removing a power supply unit adapter blank.....	245
Installing a power supply unit adapter blank.....	245
Removing a power supply unit.....	246
Installing a power supply unit.....	247
Trusted Platform Module.....	248
Upgrading the Trusted Platform Module.....	248
Initializing TPM for users.....	249
Initializing the TPM 2.0 for users.....	249
System board.....	250
Removing the system board.....	250
Installing the system board.....	251
Restoring Service Tag using Easy Restore.....	253
Manually update the Service Tag.....	253
LOM card and rear I/O board.....	253
Removing the LOM card and rear I/O board.....	253
Installing the LOM card and rear I/O board.....	255
Control panel.....	256
Removing the right control panel.....	256
Installing the right control panel.....	257

Removing the left control panel.....	258
Installing the left control panel.....	259
<b>Chapter 8: Upgrade Kits.....</b>	<b>261</b>
BOSS-N1 module kit.....	261
GPU kit.....	264
Internal USB card kit.....	267
Serial COM port kit.....	267
VGA port kit.....	267
<b>Chapter 9: Jumpers and connectors.....</b>	<b>269</b>
System board connectors.....	269
System board jumper settings.....	271
Disabling a forgotten password.....	271
<b>Chapter 10: System diagnostics and indicator codes.....</b>	<b>273</b>
Status LED indicators.....	273
System health and system ID indicator codes.....	274
iDRAC Quick Sync 2 indicator codes.....	275
iDRAC Direct LED indicator codes.....	275
LCD panel.....	276
NIC indicator codes.....	277
Power supply unit indicator codes.....	277
Drive indicator codes.....	278
<b>Chapter 11: Using system diagnostics.....</b>	<b>280</b>
Dell Embedded System Diagnostics.....	280
Running the Embedded System Diagnostics from Boot Manager.....	280
Running the Embedded System Diagnostics from the Dell Lifecycle Controller.....	280
System diagnostic controls.....	281
<b>Chapter 12: System board diagnostic LED indicators.....</b>	<b>282</b>
<b>Chapter 13: Enhanced Preboot System Assessment.....</b>	<b>283</b>
<b>Chapter 14: Getting help.....</b>	<b>285</b>
Recycling or End-of-Life service information.....	285
Contacting Dell Technologies.....	285
Accessing system information by using QRL.....	285
Quick Resource Locator for PowerEdge R7615 system.....	286
<b>Chapter 15: Receiving automated support with SupportAssist .....</b>	<b>287</b>
<b>Chapter 16: Documentation resources.....</b>	<b>288</b>

# About this document

This document provides an overview about the system, information about installing and replacing components, diagnostic tools, and guidelines to be followed while installing certain components.



## System overview

The PowerEdge R7615 system is a 2U server that supports:

- One AMD EPYC 4<sup>th</sup> Generation 9004 series processor with up to 128 cores
- 12 DDR5 DIMM slots
- Optional Direct Liquid Cooling (DLC) for required CPUs and/or configurations
- Two redundant AC or DC power supply units
- PCI Express® (PCIe) 5.0 enabled expansion slots
- Network interface technologies to cover Network Interface Card (NIC)
- Up to 12 x 3.5-inch, 8 x 3.5-inch, or 24 x 2.5-inch, 16 x 2.5-inch, 8 x 2.5-inch, or 2 x 2.5-inch(rear), 4 x 2.5-inch(rear) SAS, SATA, or NVMe (HDD/SSD) drives

**NOTE:** For more information about how to hot swap NVMe PCIe SSD U.2 device, see the *Dell Express Flash NVMe PCIe SSD User's Guide* at <https://www.dell.com/support> > **Browse all Products** > **Data Center Infrastructure** > **Storage Adapters & Controllers** > **Dell PowerEdge Express Flash NVMe PCIe SSD** > **Documentation** > **Manuals and Documents**.

**NOTE:** All instances of SAS, SATA drives are referred to as drives in this document, unless specified otherwise.

**CAUTION:** Do not install GPUs, network cards, or other PCIe devices on your system that are not validated and tested by Dell. Damage caused by unauthorized and invalidated hardware installation will null and void the system warranty.

### Topics:

- [Front view of the system](#)
- [Rear view of the system](#)
- [Inside the system](#)
- [Locating the Express Service Code and Service Tag](#)
- [System information label](#)
- [Rail sizing and rack compatibility matrix](#)

## Front view of the system



Figure 1. Front view of 24 x 2.5-inch drive system

Table 1. Features available on the front of the 24 x 2.5-inch drive system

Item	Ports, panels, and slots	Icon	Description
1	Left control panel	N/A	Contains the system health, system ID, and the status LED indicator.

**Table 1. Features available on the front of the 24 x 2.5-inch drive system (continued)**

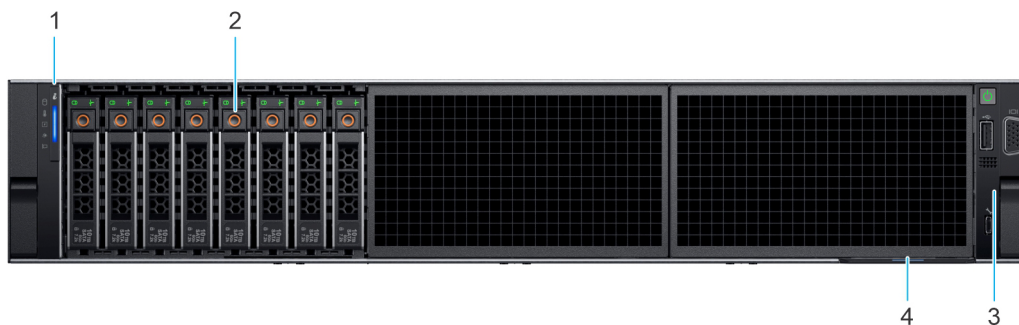
Item	Ports, panels, and slots	Icon	Description
2	Drive	N/A	Enables you to install drives that are supported on your system.
3	Right control panel	N/A	Contains the power button with integrated power LED, 1 x VGA port, 1 x 2.0 USB port, iDRAC Direct (Micro-AB USB) port, and the iDRAC Direct status LED.
4	Information tag	N/A	The Express Service Tag is a slide-out label panel that contains system information such as Service Tag, NIC, MAC address, and so on. If you have opted for the secure default access to iDRAC, the Information tag will also contain the iDRAC secure default password.



**Figure 2. Front view of 16 x 2.5-inch drive system**

**Table 2. Features available on the front of 16 x 2.5-inch drive system**

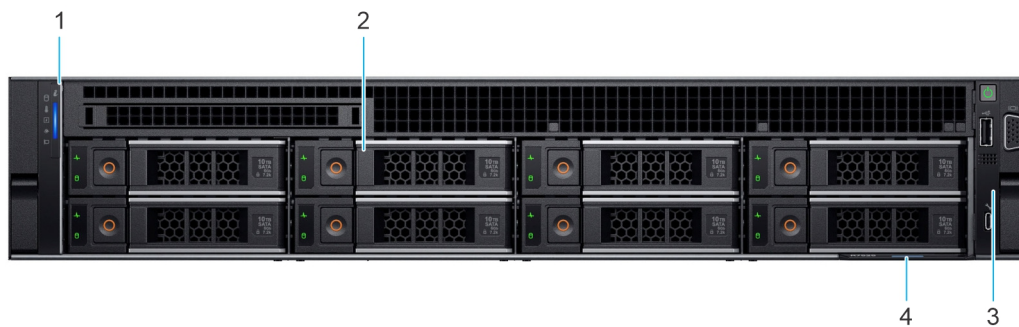
Item	Ports, panels, and slots	Icon	Description
1	Left control panel	N/A	Contains the system health, system ID, and the status LED indicator.
2	Drive	N/A	Enables you to install drives that are supported on your system.
3	Right control panel	N/A	Contains the power button with integrated power LED, 1 x VGA port, 1 x 2.0 USB port, iDRAC Direct (Micro-AB USB) port, and the iDRAC Direct status LED.
4	Information tag	N/A	The Express Service Tag is a slide-out label panel that contains system information such as Service Tag, NIC, MAC address, and so on. If you have opted for the secure default access to iDRAC, the Information tag will also contain the iDRAC secure default password.



**Figure 3. Front view of 8 x 2.5-inch drive system**

**Table 3. Features available on the front of 8 x 2.5-inch drive system**

Item	Ports, panels, and slots	Icon	Description
1	Left control panel	N/A	Contains the system health, system ID, and the status LED indicator.
2	Drive	N/A	Enables you to install drives that are supported on your system.
3	Right control panel	N/A	Contains the power button with integrated power LED, 1 x VGA port, 1 x 2.0 USB port, iDRAC Direct (Micro-AB USB) port, and the iDRAC Direct status LED.
4	Information tag	N/A	The Express Service Tag is a slide-out label panel that contains system information such as Service Tag, NIC, MAC address, and so on. If you have opted for the secure default access to iDRAC, the Information tag will also contain the iDRAC secure default password.



**Figure 4. Front view of 8 x 3.5-inch drive system**

**Table 4. Features available on the 8 x 3.5-inch drive system**

Item	Ports, panels, and slots	Icon	Description
1	Left control panel	N/A	Contains the system health, system ID, and the status LED indicator.
2	Drive	N/A	Enables you to install drives that are supported on your system.
3	Right control panel	N/A	Contains the power button with integrated power LED, 1 x VGA port, 1 x 2.0 USB port, iDRAC Direct (Micro-AB USB) port, and the iDRAC Direct status LED.
4	Information tag	N/A	The Express Service Tag is a slide-out label panel that contains system information such as Service Tag, NIC, MAC address, and so on. If you have opted for the secure default access to iDRAC, the Information tag will also contain the iDRAC secure default password.



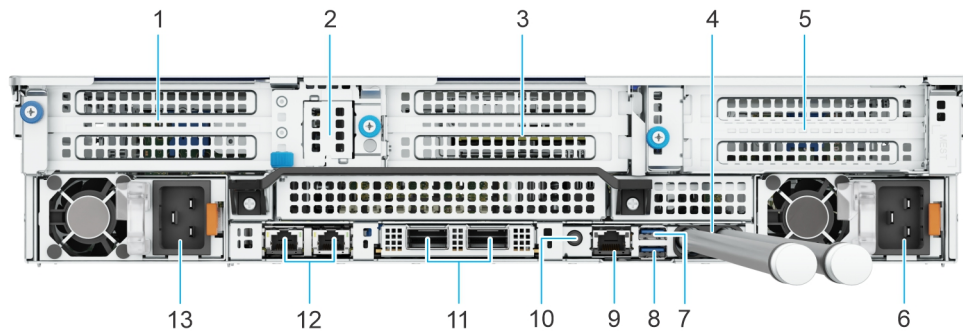
**Figure 5. Front view of 12 x 3.5-inch drive system**

**Table 5. Features available on the front of 12 x 3.5-inch drive system**

Item	Ports, panels, and slots	Icon	Description
1	Left control panel	N/A	Contains the system health, system ID, and the status LED indicator.
2	Drive	N/A	Enables you to install drives that are supported on your system.
3	Right control panel	N/A	Contains the power button with integrated power LED, 1 x VGA port, 1 x 2.0 USB port, iDRAC Direct (Micro-AB USB) port, and the iDRAC Direct status LED.
4	Information tag	N/A	The Express Service Tag is a slide-out label panel that contains system information such as Service Tag, NIC, MAC address, and so on. If you have opted for the secure default access to iDRAC, the Information tag will also contain the iDRAC secure default password.

**NOTE:** For more information about ports, panels, and slots, see the Technical specifications section.

## Rear view of the system







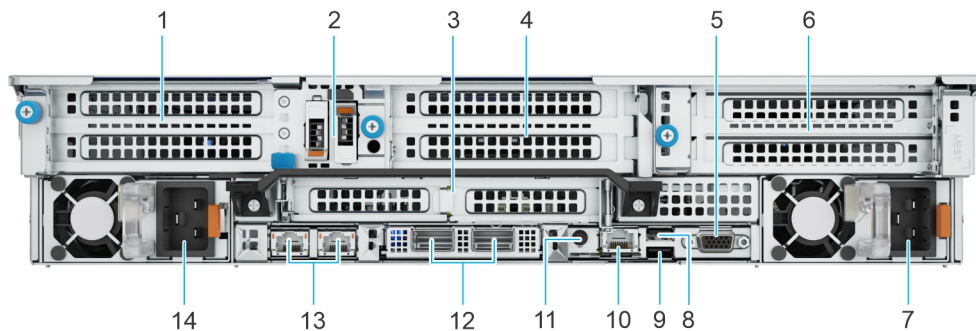
**Figure 6. Rear view of system Direct Liquid Cooling (DLC) configuration**

**Table 6. Rear view of the system with Direct Liquid Cooling (DLC) configuration**

Item	Ports, panels, or slots	Icon	Description
1	PCIe expansion card riser 1 (slot 1 and slot 2)	N/A	The expansion card riser enables you to connect PCI Express expansion cards. For more information , see the <a href="#">Expansion card installation guidelines</a> section.
2	BOSS module	N/A	BOSS-N1 module.
3	PCIe expansion card riser 3 (slot 4 and slot 5)	N/A	The expansion card riser enables you to connect PCI Express expansion cards. For more information , see the <a href="#">Expansion card installation guidelines</a> section.
4	Coolant tubes	N/A	Cold coolant flows into the system from one tube and hot coolant leaves the system from another tube.
5	PCIe expansion card riser 4 (slot 7 and slot 8)	N/A	The expansion card riser enables you to connect PCI Express expansion cards. For more information , see the <a href="#">Expansion card installation guidelines</a> section.
6	Power supply unit (PSU2)		PSU2 is the secondary PSU of the system.
7	USB 2.0 port		The USB port is 4-pin, 2.0-compliant. This port enables you to connect USB devices to the system.
8	USB 3.0 port		The USB port is 9-pin and 3.0-compliant. This port enables you to connect USB devices to the system.

**Table 6. Rear view of the system with Direct Liquid Cooling (DLC) configuration (continued)**

Item	Ports, panels, or slots	Icon	Description
9	Dedicated iDRAC9 Ethernet port		Enables you to remotely access iDRAC. For more information, see the Integrated <i>Dell Remote Access Controller User's Guide</i> at <a href="http://www.dell.com/poweredge/manuals">www.dell.com/poweredge/manuals</a> .
10	System Identification (ID) button		<p>The System Identification (ID) button is available on the front and back of the system. Press the button to identify a system in a rack by turning on the system ID button. You can also use the system ID button to reset iDRAC and to access BIOS using the step through mode. When pressed, the system ID LED in the back panel blinks until either the front or rear button is pressed again. Press the button to toggle between on or off mode.</p> <p><b>NOTE:</b> If the server stops responding during POST, press and hold the <b>System ID</b> button for more than five seconds to enter the BIOS progress mode</p> <p><b>NOTE:</b> To reset the iDRAC (if not disabled on the iDRAC setup page by pressing F2 during system boot), press and hold the <b>System ID</b> button for more than 15 seconds.</p>
11	OCP NIC card	N/A	The OCP NIC card supports OCP 3.0. The NIC ports are integrated on the OCP card which is connected to the system board.
12	NIC ports		The NIC ports that are integrated on the LOM card provide network connectivity which is connected to the system board.
13	Power supply unit (PSU1)		PSU1 is the primary PSU of the system.










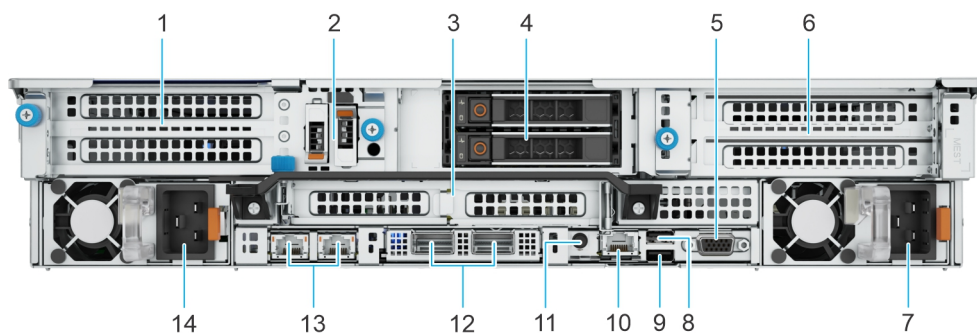
**Figure 7. Rear view of the system**

**Table 7. Rear view of the system**

Item	Ports, panels, or slots	Icon	Description
1	PCIe expansion card riser 1 (slot 1 and slot 2)	N/A	The expansion card riser enables you to connect PCI Express expansion cards. For more information , see the <a href="#">Expansion card installation guidelines</a> section.
2	BOSS module	N/A	BOSS-N1 module.
3	PCIe expansion card riser 2 (slot 3 and slot 6)	N/A	The expansion card riser enables you to connect PCI Express expansion cards. For more information , see the <a href="#">Expansion card installation guidelines</a> section.
4	PCIe expansion card riser 3 (slot 5)	N/A	The expansion card riser enables you to connect PCI Express expansion cards. For more information , see the <a href="#">Expansion card installation guidelines</a> section.
5	VGA port	NA	Enables you to connect a display device to the system.

**Table 7. Rear view of the system (continued)**

Item	Ports, panels, or slots	Icon	Description
6	PCIe expansion card riser 4 (slot 7)	N/A	The expansion card riser enables you to connect PCI Express expansion cards. For more information , see the <a href="#">Expansion card installation guidelines</a> section.
7	Power supply unit (PSU2)		PSU2 is the secondary PSU of the system.
8	USB 2.0 port		The USB port is 4-pin, 2.0-compliant. This port enables you to connect USB devices to the system.
9	USB 3.0 port		The USB port is 9-pin and 3.0-compliant. This port enables you to connect USB devices to the system.
10	Dedicated iDRAC9 Ethernet port		Enables you to remotely access iDRAC. For more information, see the <i>Integrated Dell Remote Access Controller User's Guide</i> at <a href="http://www.dell.com/poweredgemanuals">www.dell.com/poweredgemanuals</a> .
11	System Identification (ID) button		The System Identification (ID) button is available on the front and back of the system. Press the button to identify a system in a rack by turning on the system ID button. You can also use the system ID button to reset iDRAC and to access BIOS using the step through mode. When pressed, the system ID LED in the back panel blinks until either the front or rear button is pressed again. Press the button to toggle between on or off mode. <b>NOTE:</b> If the server stops responding during POST, press and hold the <b>System ID</b> button for more than five seconds to enter the BIOS progress mode <b>NOTE:</b> To reset the iDRAC (if not disabled on the iDRAC setup page by pressing F2 during system boot), press and hold the <b>System ID</b> button for more than 15 seconds.
12	OCP NIC card	N/A	The OCP NIC card supports OCP 3.0. The NIC ports are integrated on the OCP card which is connected to the system board.
13	NIC ports		The NIC ports that are integrated on the LOM card provide network connectivity which is connected to the system board.
14	Power supply unit (PSU1)		PSU1 is the primary PSU of the system.










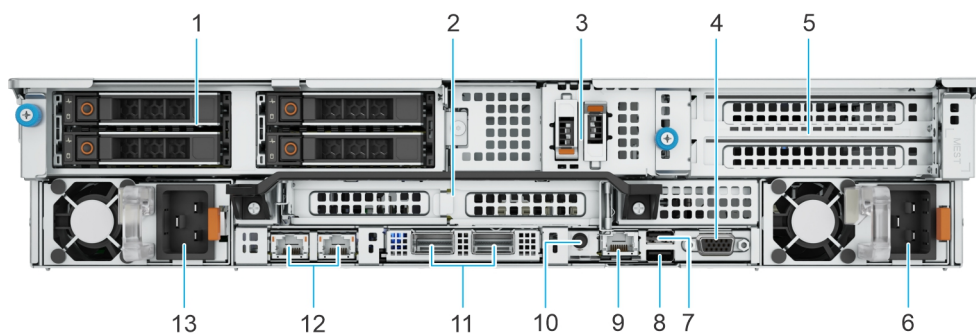
**Figure 8. Rear view of the system with 2 x 2.5-inch rear drive module**

**Table 8. Rear view of the system with 2 x 2.5-inch rear drive module**

Item	Ports, panels, or slots	Icon	Description
1	PCIe expansion card riser 1 (slot 1 and slot 2)	N/A	The expansion card riser enables you to connect PCI Express expansion cards. For more information , see the <a href="#">Expansion card installation guidelines</a> section.
2	BOSS module	N/A	BOSS-N1 module.








**Table 8. Rear view of the system with 2 x 2.5-inch rear drive module (continued)**

Item	Ports, panels, or slots	Icon	Description
3	PCIe expansion card riser 2 (slot 3 and slot 6)	N/A	The expansion card riser enables you to connect PCI Express expansion cards. For more information , see the <a href="#">Expansion card installation guidelines</a> section.
4	Drives	N/A	Enables you to install drives that are supported on your system.
5	VGA port	NA	Enables you to connect a display device to the system.
6	PCIe expansion card riser 4 (slot 7)	N/A	The expansion card riser enables you to connect PCI Express expansion cards. For more information , see the <a href="#">Expansion card installation guidelines</a> section.
7	Power supply unit (PSU2)		PSU2 is the secondary PSU of the system.
8	USB 2.0 port		The USB port is 4-pin, 2.0-compliant. This port enables you to connect USB devices to the system.
9	USB 3.0 port		The USB port is 9-pin and 3.0-compliant. This port enables you to connect USB devices to the system.
10	Dedicated iDRAC9 Ethernet port		Enables you to remotely access iDRAC. For more information, see the <i>Integrated Dell Remote Access Controller User's Guide</i> at <a href="http://www.dell.com/poweredgemanuals">www.dell.com/poweredgemanuals</a> .
11	System Identification (ID) button		The System Identification (ID) button is available on the front and back of the system. Press the button to identify a system in a rack by turning on the system ID button. You can also use the system ID button to reset iDRAC and to access BIOS using the step through mode. When pressed, the system ID LED in the back panel blinks until either the front or rear button is pressed again. Press the button to toggle between on or off mode. <b>NOTE:</b> If the server stops responding during POST, press and hold the <b>System ID</b> button for more than five seconds to enter the BIOS progress mode <b>NOTE:</b> To reset the iDRAC (if not disabled on the iDRAC setup page by pressing F2 during system boot), press and hold the <b>System ID</b> button for more than 15 seconds.
12	OCP NIC card	N/A	The OCP NIC card supports OCP 3.0. The NIC ports are integrated on the OCP card which is connected to the system board.
13	NIC ports		The NIC ports that are integrated on the LOM card provide network connectivity which is connected to the system board.
14	Power supply unit (PSU1)		PSU1 is the primary PSU of the system.



**Figure 9. Rear view of the system with 4 x 2.5-inch rear drive module**

**Table 9. Rear view of the system with 4 x 2.5-inch rear drive module**

Item	Ports, panels, or slots	Icon	Description
1	Drives	N/A	Enables you to install drives that are supported on your system.
2	PCIe expansion card riser 2	N/A	The expansion card riser enables you to connect PCI Express expansion cards. For more information , see the <a href="#">Expansion card installation guidelines</a> section.
3	BOSS module	N/A	BOSS-N1 module.
4	VGA port	NA	Enables you to connect a display device to the system.
5	PCIe expansion card riser 4	N/A	The expansion card riser enables you to connect PCI Express expansion cards. For more information , see the <a href="#">Expansion card installation guidelines</a> section.
5	Coolant tubes	N/A	Cold coolant flows into the system from one tube and hot coolant leaves the system from another tube.
6	Power supply unit (PSU2)		PSU2 is the secondary PSU of the system.
7	USB 2.0 port		The USB port is 4-pin, 2.0-compliant. This port enables you to connect USB devices to the system.
8	USB 3.0 port		The USB port is 9-pin and 3.0-compliant. This port enables you to connect USB devices to the system.
9	Dedicated iDRAC9 Ethernet port		Enables you to remotely access iDRAC. For more information, see the Integrated <i>Dell Remote Access Controller User's Guide</i> at <a href="http://www.dell.com/poweredge/manuals">www.dell.com/poweredge/manuals</a> .
10	System Identification (ID) button		<p>The System Identification (ID) button is available on the front and back of the system. Press the button to identify a system in a rack by turning on the system ID button. You can also use the system ID button to reset iDRAC and to access BIOS using the step through mode. When pressed, the system ID LED in the back panel blinks until either the front or rear button is pressed again. Press the button to toggle between on or off mode.</p> <p><b>i NOTE:</b> If the server stops responding during POST, press and hold the <b>System ID</b> button for more than five seconds to enter the BIOS progress mode</p> <p><b>i NOTE:</b> To reset the iDRAC (if not disabled on the iDRAC setup page by pressing F2 during system boot), press and hold the <b>System ID</b> button for more than 15 seconds.</p>
11	OCP NIC card	N/A	The OCP NIC card supports OCP 3.0. The NIC ports are integrated on the OCP card which is connected to the system board.
12	NIC ports		The NIC ports that are integrated on the LOM card provide network connectivity which is connected to the system board.
13	Power supply unit (PSU1)		PSU1 is the primary PSU of the system.

**i NOTE:** For more information about ports, panels, and slots, see the Technical specifications section.



# Inside the system

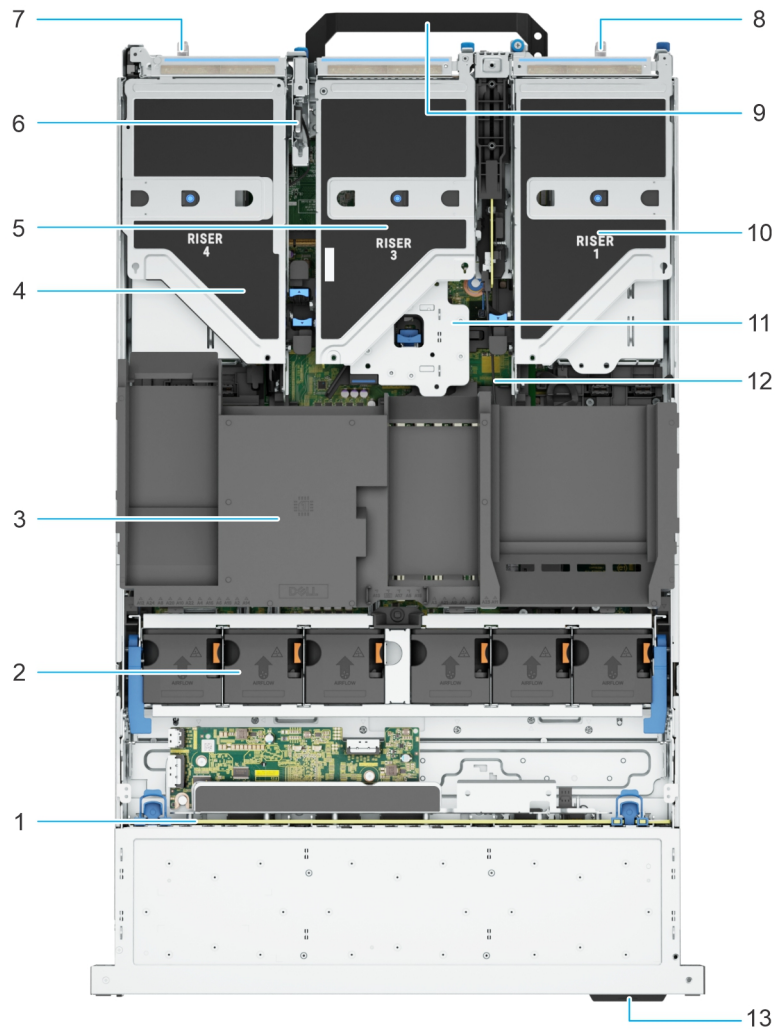
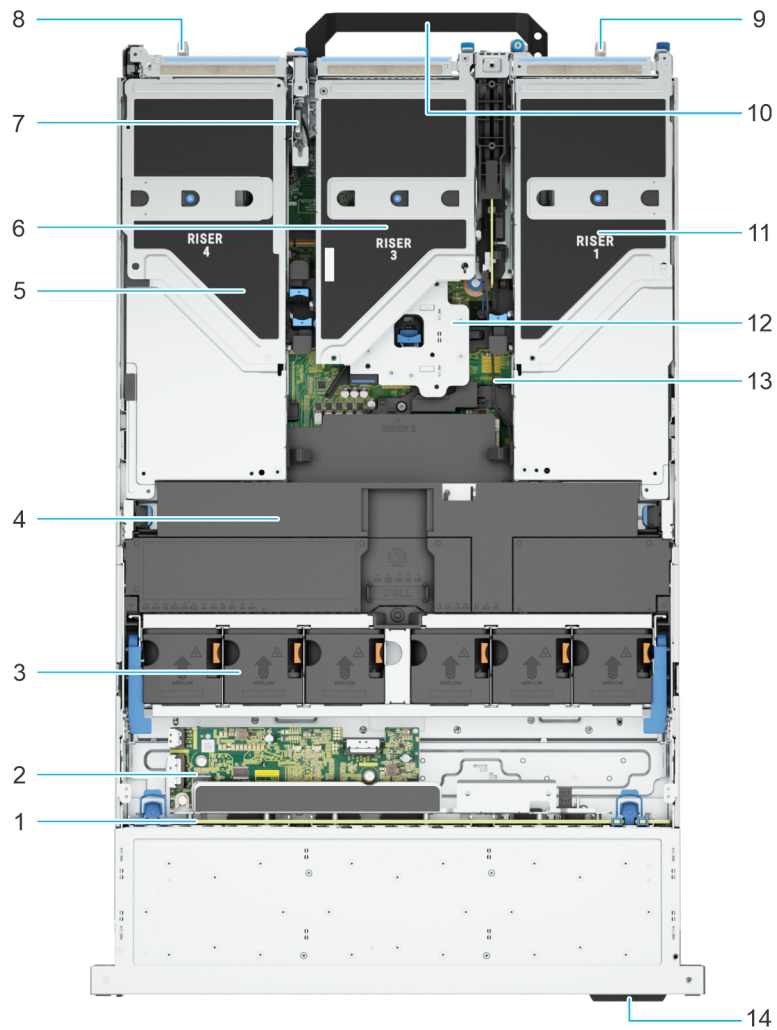


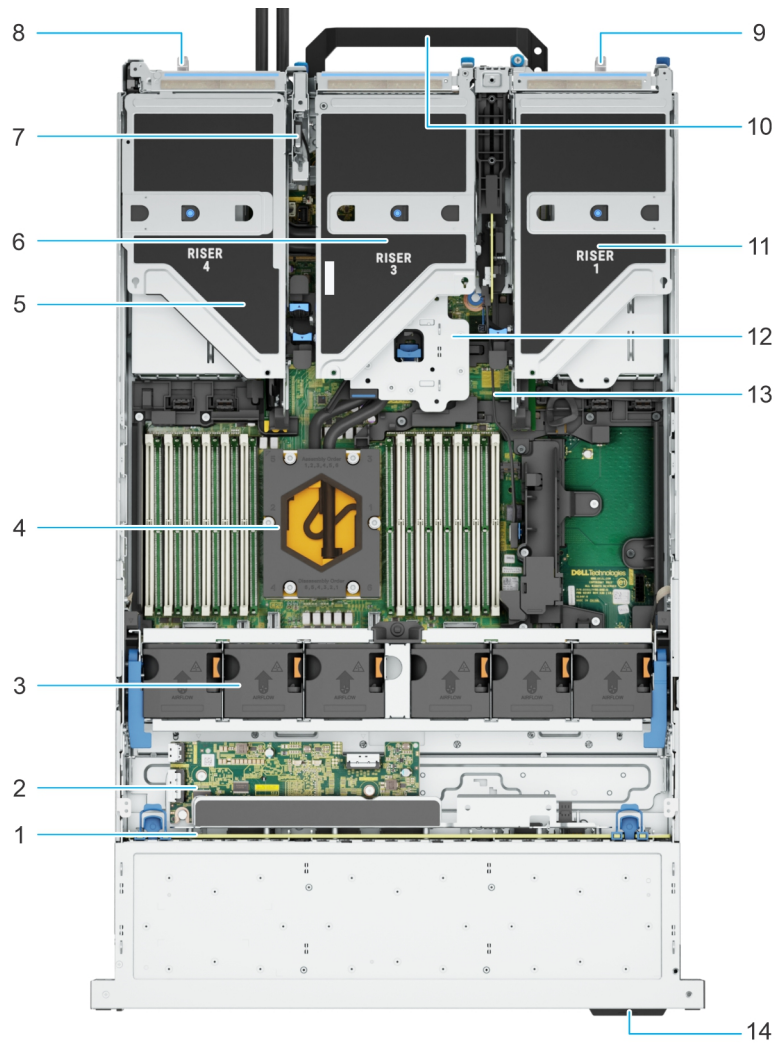
Figure 10. Inside the system

- 1. Drive backplane
- 2. Cooling fan cage assembly
- 3. Air shroud top cover
- 4. Riser 4
- 5. Riser 3
- 6. Intrusion switch
- 7. Power Supply Unit (PSU 1)
- 8. Power Supply Unit (PSU 2)
- 9. Handle
- 10. Riser 1
- 11. Riser 2
- 12. System board
- 13. Information tag



**Figure 11. Inside the system with full length risers and GPU shroud**

1. Drive backplane
2. Expansion card board
3. Cooling fan cage assembly
4. GPU air shroud top cover
5. Riser 4
6. Riser 3
7. Intrusion switch
8. Power Supply Unit (PSU 1)
9. Power Supply Unit (PSU 2)
10. Handle
11. Riser 1
12. Riser 2
13. System board
14. Information tag



**Figure 12. Inside the system with processor liquid cooling module**

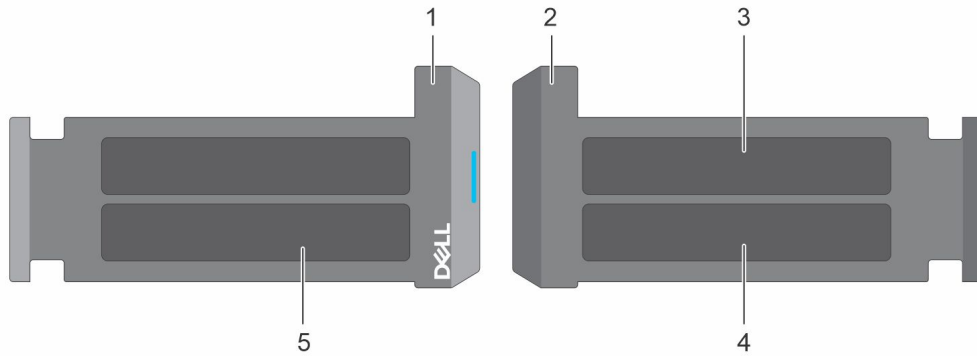
1. Drive backplane
2. Expansion card board
3. Cooling fan cage assembly
4. Liquid cooling module
5. Riser 4
6. Riser 3
7. Intrusion switch
8. Power Supply Unit (PSU 1)
9. Power Supply Unit (PSU 2)
10. Handle
11. Riser 1
12. Riser 3
13. System board
14. Information tag

**NOTE:** To show the liquid cooling configuration system, air shroud is not shown in the image.

## Locating the Express Service Code and Service Tag

The unique Express Service Code and Service Tag is used to identify the system. The information tag is located on the front of the system that includes system information such as Service Tag, Express Service Code, Manufacture date, NIC, MAC address,

QRL label, and so on. If you have opted for the secure default access to iDRAC, the Information tag also contains the iDRAC secure default password. If you have opted for iDRAC Quick Sync 2, the Information tag also contains the OpenManage Mobile (OMM) label, where administrators can configure, monitor, and troubleshoot the PowerEdge servers.



**Figure 13. Locating the Express Service Code and Service tag**

- 1. Information tag (front view)
- 2. Information tag (back view)
- 3. OpenManage Mobile (OMM) label
- 4. iDRAC MAC address and iDRAC secure password label
- 5. Service Tag, Express Service Code, QRL label

The Mini Enterprise Service Tag (MEST) label is located on the rear of the system that includes Service Tag (ST), Express Service Code (Exp Svc Code), and Manufacture Date (Mfg. Date). The Exp Svc Code is used by Dell to route support calls to the appropriate personnel.

Alternatively, the Service Tag information is located on a label on left wall of the chassis.

## System information label

The system information label is located on the back side of the system cover.

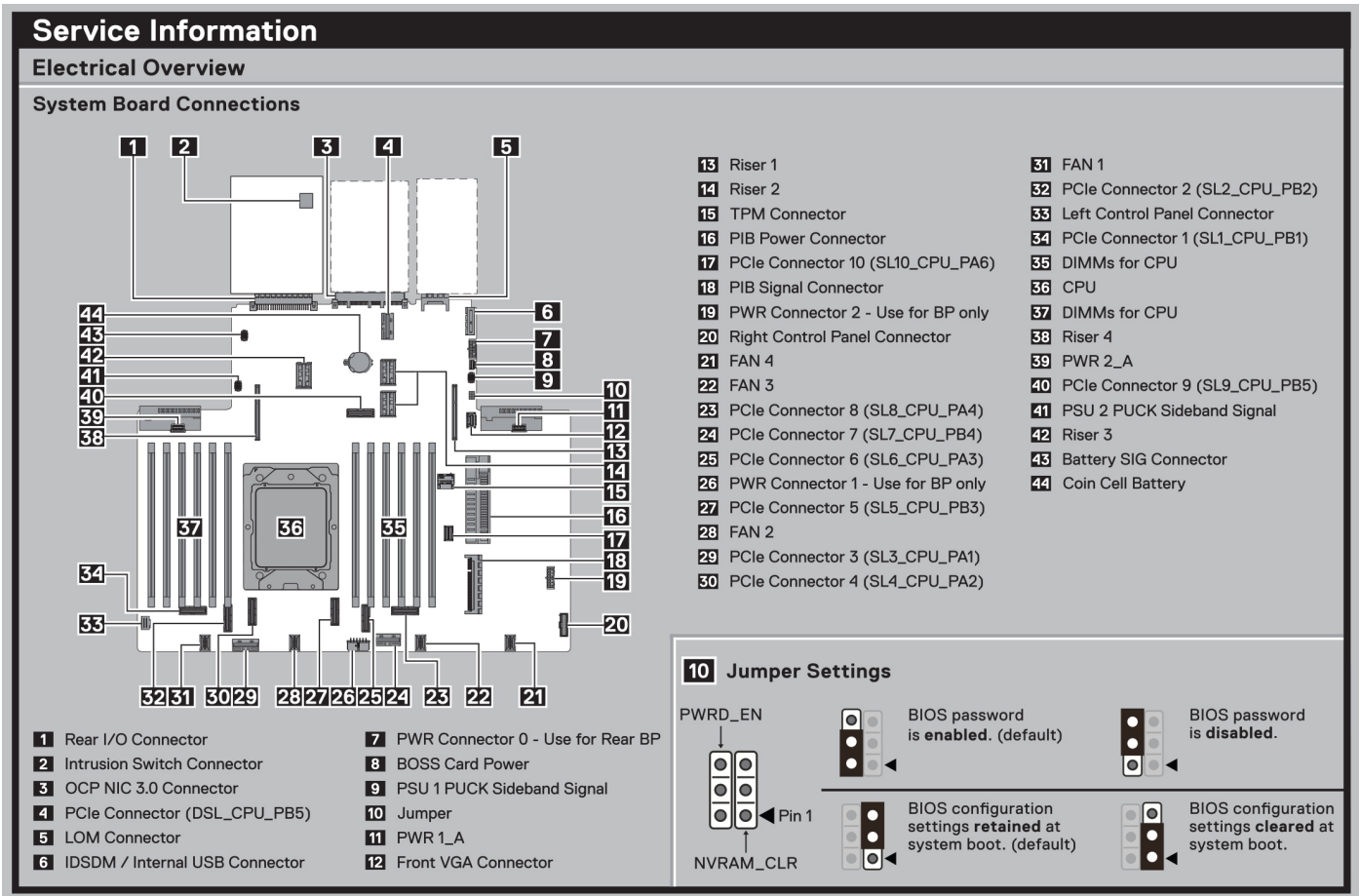


Figure 14. Service information

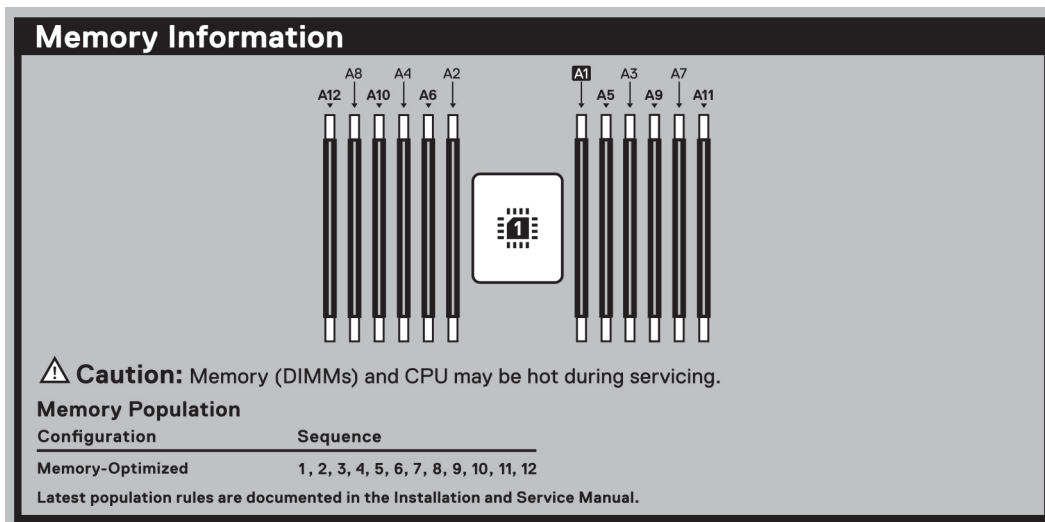


Figure 15. Memory information

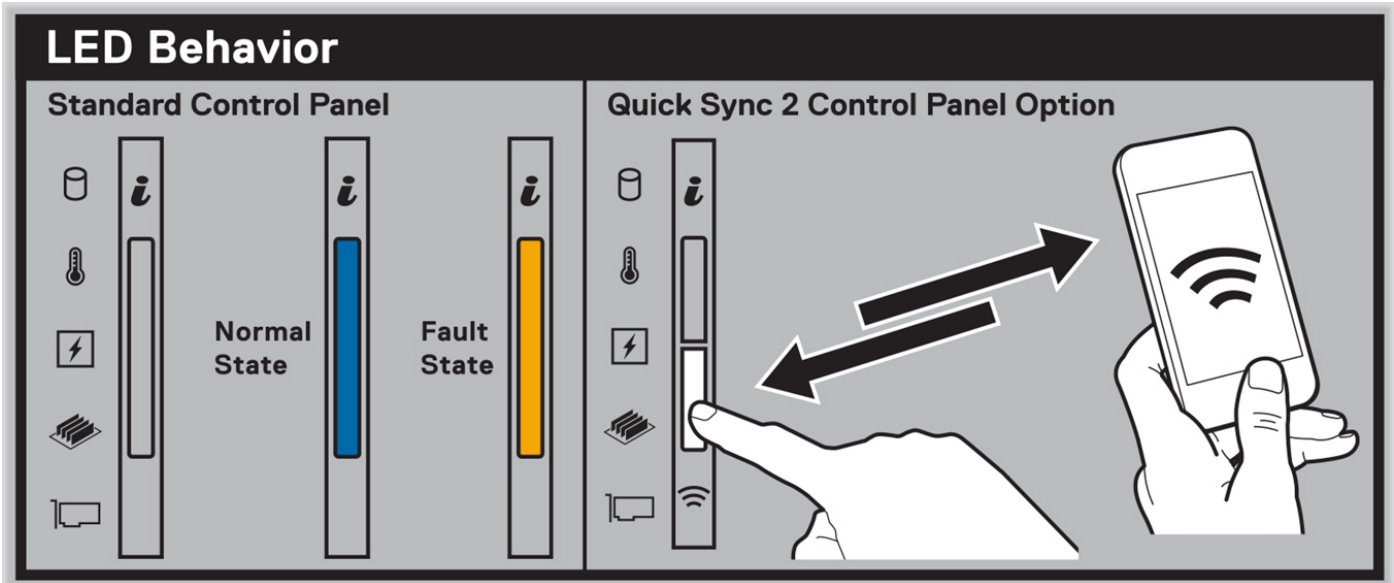


Figure 16. LED behavior

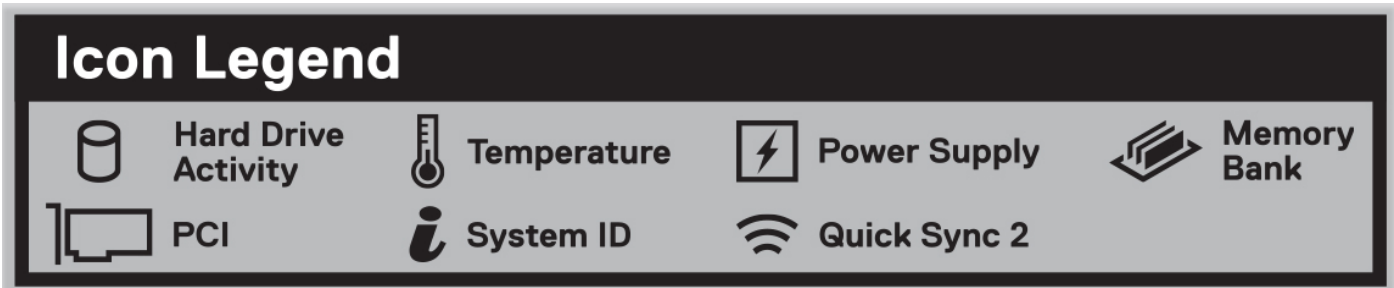


Figure 17. Icon legend

# Configuration and Layout

Hot Swap Touchpoints (terracotta)

Cold Swap Touchpoints (blue)

## Front View

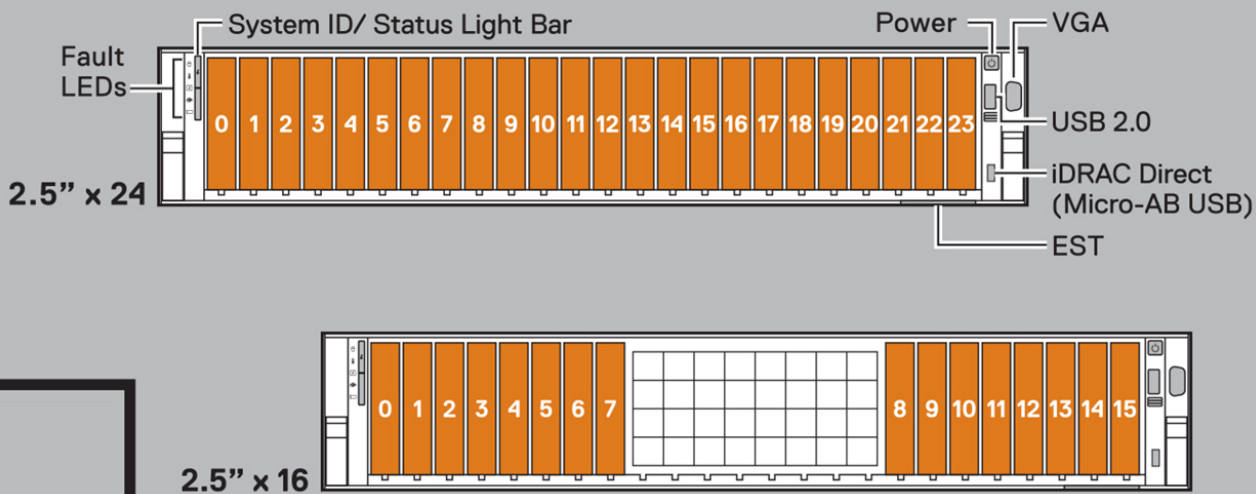


Figure 18. Configuration and layout for 2.5-inch drive system

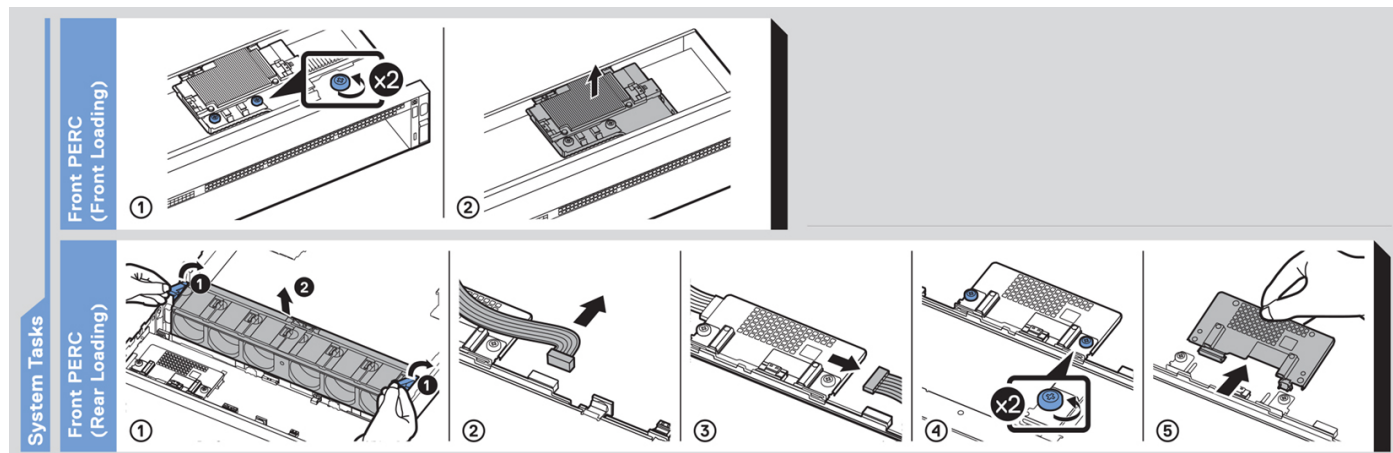
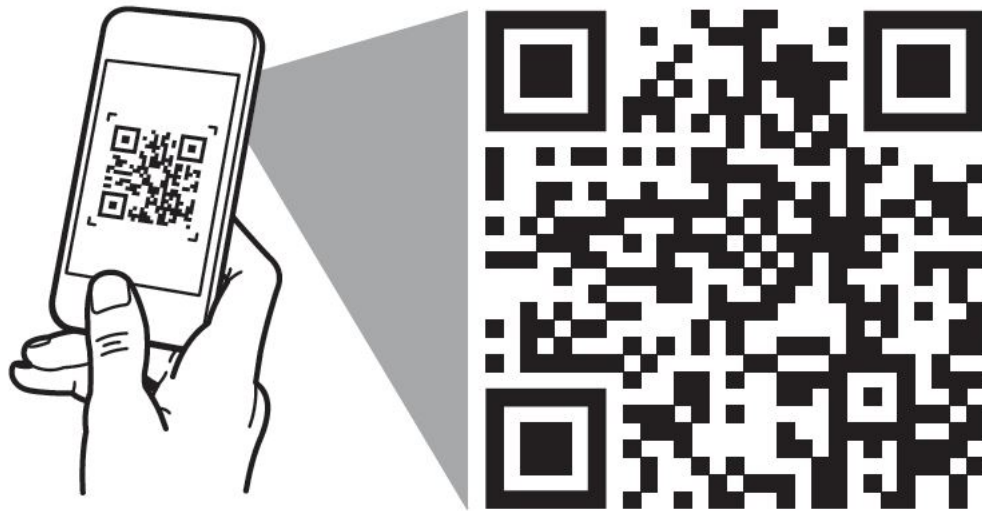


Figure 19. System tasks



## Quick Resource Locator

Dell.com/QRL/Server/PER7615

Figure 20. Express service tag

### Rail sizing and rack compatibility matrix

For specific information about the rail solutions compatible with your system, see the *Dell Technologies Enterprise Systems Rail Sizing and Rack Compatibility Matrix* available at [https://i.dell.com/sites/csdocuments/Business\\_solutions\\_engineering-Docs\\_Documents/en/rail-rack-matrix.pdf](https://i.dell.com/sites/csdocuments/Business_solutions_engineering-Docs_Documents/en/rail-rack-matrix.pdf).

The document provides the information that is listed below:

- Specific details about rail types and their functionalities.
- Rail adjustability range for various types of rack mounting flanges.
- Rail depth with and without cable management accessories.
- Types of racks supported for various types of rack mounting flanges.



# Technical specifications

The technical and environmental specifications of your system are outlined in this section.

**Topics:**

- Chassis dimensions
- System weight
- PSU specifications
- Processor specifications
- Supported operating systems
- Cooling fan specifications
- System battery specifications
- Expansion card riser specifications
- Memory specifications
- Storage controller specifications
- GPU specifications
- Drives
- Ports and connectors specifications
- Video specifications
- Environmental specifications

# Chassis dimensions

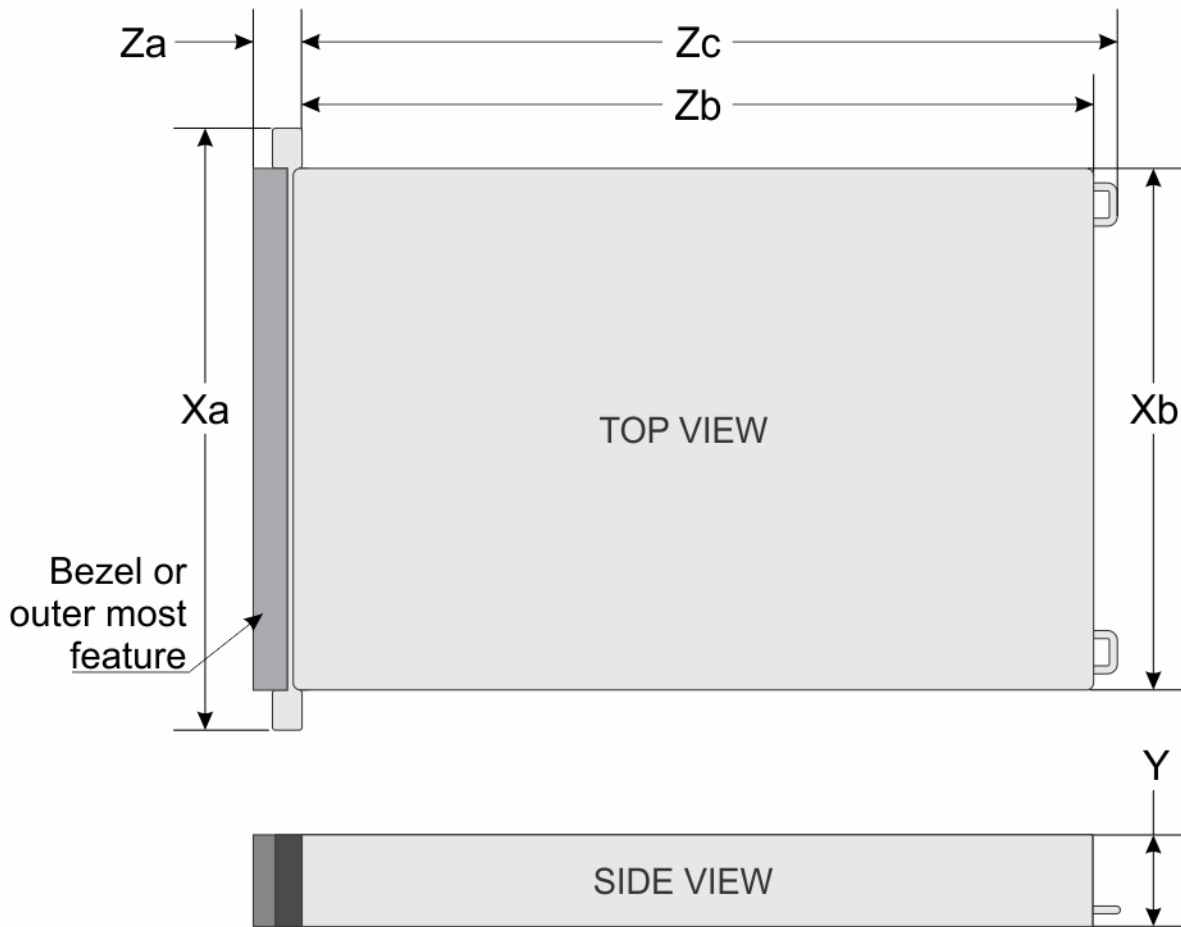


Figure 21. Chassis dimensions

Table 10. PowerEdge R7615 chassis dimensions

Xa	Xb	Y	Za	Zb	Zc
482.0 mm (18.97 inches)	434.0 mm (17.08 inches)	86.8 mm (3.41 inches)	35.84 mm (1.96 inches) With bezel 22.0 mm (0.86 inches) Without bezel	700.7 mm (27.58 inches) Ear to rear wall	736.29 mm (28.98 inches) Ear to PSU handle

**NOTE:** Zb is the nominal rear wall external surface where the system board I/O connectors reside.

# System weight

Table 11. PowerEdge R7615 system weight

System configuration	Maximum weight (with all drives/SSDs)
A server with fully populated drives	34.5 kg (76.05 pound)
A server without drives and PSU installed	25.7 kg (56.65 pound)

# PSU specifications

The PowerEdge R7615 system supports up to two AC or DC power supply units (PSUs).

**Table 12. PSU specifications**

PSU	Class	Heat dissipation (maximum) (BTU/hr)	Frequency (Hz)	Voltage	AC		DC	Current (A)
					High line wattage (200—240 V AC)	Low line wattage (100—120 V AC)		
700 W mixed mode	Titanium	2625	50/60	200—240 V AC	700 W	N/A	N/A	4.1
	N/A	2625	N/A	240 V DC	N/A	N/A	700 W	3.4
800 W mixed mode	Platinum	3000	50/60	100—240 V AC	800 W	800 W	N/A	9.2—4.7
	N/A	3000	N/A	240 V DC	N/A	N/A	800 W	3.8
1100 W mixed mode	Titanium	4125	50/60	100—240 V AC	1100 W	1050 W	N/A	12—6.3
	N/A	4125	N/A	240 V DC	N/A	N/A	1100 W	5.2
1100 W DC	N/A	4265	N/A	-48— -60 V DC	N/A	N/A	1100 W	27
1400 W mixed mode	Platinum	5250	50/60	100—240 V AC	1400 W	1050 W	N/A	12—8
	N/A	5250	N/A	240 V DC	N/A	N/A	1400 W	6.6
1800 W mixed mode	Titanium	6610	50/60	200—240 V AC	1800	N/A	N/A	10
	N/A	6610	N/A	240 V DC	N/A	N/A	1800 W	8.2
2400 W mixed mode	Platinum	9000	50/60	100—240 V AC	2400 W	1400 W	N/A	16—13.5
	N/A	9000	N/A	240 V DC	N/A	N/A	2400 W	11.2

**NOTE:** If a system with AC 1400 W or 1100 W PSUs operates at low line 100-120 V AC, and then the power rating per PSU is degraded to 1050 W.

**NOTE:** If a system with AC 2400 W PSUs operates at low line 100-120 V AC, and then the power rating per PSU is degraded to 1400 W.

**NOTE:** Heat dissipation is calculated using the PSU wattage rating.


**NOTE:** When selecting or upgrading the system configuration, to ensure optimum power utilization, verify the system power consumption with the Enterprise Infrastructure Planning Tool available at [Dell.com/calc](http://Dell.com/calc).



**Figure 22. PSU power cords**

**Table 13. PSU power cords**

Form factor	Output	Power cord
Redundant 60 mm	700 W AC	C13
	800 W AC	C13
	1100 W AC	C13
	1100 W -48 LVDC	C13
	1400 W AC	C13
	1800 W AC	C15
Redundant 86 mm	2400 W AC	C19

 **NOTE:** C13 power cord combined with C14 to C15 jumper power cord can be used to adapt 1800 W PSU.

## Processor specifications

**Table 14. PowerEdge R7615 processor specifications**

Supported processor	Number of processor supported
4 <sup>th</sup> Generation AMD EPYC 9004 Series processor	One

## Supported operating systems

The PowerEdge R7615 system supports the following operating systems:

- Canonical Ubuntu Server LTS
- Microsoft Windows Server with Hyper-V
- Red Hat Enterprise Linux
- SUSE Linux Enterprise Server
- VMware ESXi

For more information, go to [www.dell.com/ossupport](http://www.dell.com/ossupport).

## Cooling fan specifications

### Cooling options

The PowerEdge R7615 requires various cooling components that based on CPU TDP, storage modules, rear drives, GPU, and persistent memory to maintain optimum thermal performance.

The PowerEdge R7615 offers two types of cooling options:

- Air cooling
- Processor liquid cooling (optional)

### Cooling fan specifications

The PowerEdgeR7615system system supports up to six high-performance silver grade (HPR SLVR) or high-performance gold (HPR Gold) cooling fans.

**Table 15. Cooling fan specifications**

Fan type	Abbreviation	Label color	Label image
High performance Silver (HPR) fans	HPR SLVR	Silver	
High performance Gold (HPR Gold) fans	HPR Gold	Gold Grade	

## System battery specifications

The PowerEdge R7615 system uses one CR 2032 3.0-V lithium coin cell battery.

## Expansion card riser specifications

The PowerEdge R7615 system supports up to eight PCI express (PCIe) slots (six full lengths and two low profiles) on the system board.

**Table 16. Expansion card slots supported on the system board**

PCIe slot	With Regular shroud	With GPGPU shroud	R1U	R1T	R2A	R2T	R3A	R3B	R4A	R4P	R4Q	R4S
Slot 1	Full height - Half length	Full height - Full length	x8 (Gen5)	-	-	x16	-	-	-	-	-	-
Slot 2	Full height - Half length	Full height - Full length	x8 (Gen5)	x16 (Gen5) (Double width GPU)	-	x16	-	-	-	-	-	-
Slot 3	Low profile - Half length	Low profile - Half length	-	-	x8	-	-	-	-	-	-	-
Slot 4	Full height -	Full height -	-	-	-	-	-	x8	-	-	-	-

**Table 16. Expansion card slots supported on the system board (continued)**

PCIe slot	With Regular shroud	With GPGPU shroud	R1U	R1T	R2A	R2T	R3A	R3B	R4A	R4P	R4Q	R4S
	Half length	Half length										
Slot 5	Full height - Half length	Full height - Full length	-	-	-	-	x16	x8	-	-	-	-
Slot 6	Low profile - Half length	Low profile - Half length	-	-	x8	-	-	-	-	-	-	-
Slot 7	Full height - Half length	Full height - Full length	-	-	-	-	-	-	x16	x16 (Gen5) (Double width GPU)	x8 (Gen5)	x16 (Gen5)
Slot 8	Full height - Half length	Full height - Half length	-	-	-	-	-	-	-	-	x8 (Gen5)	x16 (Gen5)

## Memory specifications

The PowerEdge R7615 system supports the following memory specifications for optimized operation.

**Table 17. Memory specifications**

DIMM type	DIMM rank	DIMM capacity	Single processor	
			Minimum system capacity	Maximum system capacity
DDR5 RDIMM	Single rank	16 GB	16 GB	196 GB
	Dual rank	32 GB	32 GB	384 GB
	Dual rank	64 GB	64 GB	768 GB
	Quad rank	128 GB	128 GB	1536 GB
	Octa rank	256 GB	256 GB	3072 GB

**Table 18. Memory module sockets**

Memory module sockets	Speed
12 (288-pin)	4800 MT/s

- NOTE:** DDR4 DIMM memory is not supported.
- NOTE:** Memory DIMM slots are not hot pluggable.
- NOTE:** Do not mix DIMM module types within a memory channel. All must be RDIMM or 3DS RDIMM module types with same ECC configuration.
- NOTE:** Do not mix x4 and x8 DIMMs with a memory channel.

# Storage controller specifications


The PowerEdge R7615 system supports the following controller card:

**Table 19. Storage controller cards**

Supported storage controller card
Software RAID <ul style="list-style-type: none"><li>• S160</li></ul>
Internal controllers <ul style="list-style-type: none"><li>• PERC H965i</li><li>• PERC H755</li><li>• PERC H755N</li><li>• PERC H355</li></ul>
Internal Boot <ul style="list-style-type: none"><li>• Boot Optimized Storage Subsystem (BOSS-N1): HWRAID 2 x M.2 SSDs</li></ul>
External controllers <ul style="list-style-type: none"><li>• HBA355e</li></ul>
SAS Host Bus Adapters <ul style="list-style-type: none"><li>• HBA355i</li></ul>

# GPU specifications


The PowerEdge R7615 system supports up to three 300 W double-width GPUs or eight 60 W single-width GPUs.

 **NOTE:** Systems configured with GPUs will have higher fan acoustics.

# Drives

The PowerEdge R7615 system supports:

- 8 x 3.5-inch hot-swappable SAS or SATA drives
- 12 x 3.5-inch hot-swappable SAS or SATA drives
- 8 x 2.5-inch hot-swappable NVMe drives
- 16 x 2.5-inch hot-swappable SAS, SATA, or NVMe drives
- 24 x 2.5-inch hot-swappable SAS or SATA drives
- 2 x 2.5-inch rear hot-swappable SAS, SATA, or NVMe drives
- 4 x 2.5-inch rear hot-swappable SAS, SATA, or NVMe drives
- Zero drive

 **NOTE:** For more information about how to hot swap NVMe PCIe SSD U.2 device, see the *Dell Express Flash NVMe PCIe SSD User's Guide* at <https://www.dell.com/support> > **Browse all Products** > **Data Center Infrastructure** > **Storage Adapters & Controllers** > **Dell PowerEdge Express Flash NVMe PCIe SSD** > **Documentation** > **Manuals and Documents**.

# Ports and connectors specifications

## USB ports specifications

Table 20. PowerEdge R7615 USB specifications

Front		Rear		Internal (optional)	
USB port type	No. of ports	USB port type	No. of ports	USB port type	No. of ports
USB 2.0-compliant port	One	USB 2.0-compliant port	One	Internal USB 3.0-compliant port	One
iDRAC Direct port (Micro-AB USB 2.0-compliant port)	One	USB 3.0-compliant port	One		

**NOTE:** The micro USB 2.0 compliant port can only be used as an iDRAC Direct or a management port.

## NIC port specifications

The PowerEdge R7615 system supports up to two 10/100/1000 Mbps Network Interface Controller (NIC) ports embedded on the LAN on Motherboard (LOM) and integrated on the Open Compute Project (OCP) cards.

Table 21. NIC port specification for the system

Feature	Specifications
(Optional) LOM card	1 Gb x 2
(Optional) OCP card (OCP 3.0)	1GbE x 4, 10 GbE x 2, 10 GbE x 4, 25 GbE x 2, 25 GbE x 4

**NOTE:** The system allows either LOM card or an OCP card or both to be installed in the system.

**NOTE:** On the system board, the supported OCP PCIe width is x8; when x16 PCIe width is installed, it is downgraded to x8.

## Serial connector specifications

The PowerEdge R7615 system supports one optional card type serial connector, which is a 9-pin connector, Data Terminal Equipment (DTE), 16550-compliant .

The optional serial connector card is installed similar to an expansion card filler bracket.

## VGA ports specifications

The PowerEdge R7615 system supports One DB-15 VGA port on the front panel and one on the rear panel (optional for processor liquid cooling).

## Video specifications

The PowerEdge R7615 system supports integrated Matrox G200 graphics controller with 16 MB of video frame buffer.

Table 22. Supported video resolution options

Resolution	Refresh rate (Hz)	Color depth (bits)
1024 x 768	60	8, 16, 32



**Table 22. Supported video resolution options (continued)**

Resolution	Refresh rate (Hz)	Color depth (bits)
1280 x 800	60	8, 16, 32
1280 x 1024	60	8, 16, 32
1360 x 768	60	8, 16, 32
1440 x 900	60	8, 16, 32
1600 x 900	60	8, 16, 32
1600 x 1200	60	8, 16, 32
1680 x 1050	60	8, 16, 32
1920 x 1080	60	8, 16, 32
1920 x 1200	60	8, 16, 32

## Environmental specifications

**Table 23. Continuous Operation Specifications for ASHRAE A2**

Temperature	Specifications
Allowable continuous operations	
Temperature range for altitudes <= 900 m (<= 2953 ft)	10–35°C (50–95°F) with no direct sunlight on the equipment
Humidity percent range (non-condensing at all times)	8% RH with -12°C minimum dew point to 80% RH with 21°C (69.8°F) maximum dew point
Operational altitude de-rating	Maximum temperature is reduced by 1°C/300 m (1.8°F/984 Ft) above 900 m (2953 Ft)

**Table 24. Continuous Operation Specifications for ASHRAE A3**

Temperature	Specifications
Allowable continuous operations	
Temperature range for altitudes <= 900 m (<= 2953 ft)	5–40°C (41–104°F) with no direct sunlight on the equipment
Humidity percent range (non-condensing at all times)	8% RH with -12°C minimum dew point to 85% RH with 24°C (75.2°F) maximum dew point
Operational altitude de-rating	Maximum temperature is reduced by 1°C/175 m (1.8°F/574 Ft) above 900 m (2953 Ft)

**Table 25. Continuous Operation Specifications for ASHRAE A4**

Temperature	Specifications
Allowable continuous operations	
Temperature range for altitudes <= 900 m (<= 2953 ft)	5–45°C (41–113°F) with no direct sunlight on the equipment

**Table 25. Continuous Operation Specifications for ASHRAE A4 (continued)**

Temperature	Specifications
Humidity percent range (non-condensing at all times)	8% RH with -12°C minimum dew point to 90% RH with 24°C (75.2°F) maximum dew point
Operational altitude de-rating	Maximum temperature is reduced by 1°C/125 m (1.8°F/410 Ft) above 900 m (2953 Ft)

**Table 26. Common Environmental Specifications for ASHRAE A2, A3 and A4**

Temperature	Specifications
Allowable continuous operations	
Maximum temperature gradient (applies to both operation and non-operation)	20°C in an hour* (36°F in an hour) and 5°C in 15 minutes (9°F in 15 minutes), 5°C in an hour* (9°F in an hour) for tape hardware <i>i</i> <b>NOTE:</b> * - Per ASHRAE thermal guidelines for tape hardware, these are not instantaneous rates of temperature change.
Non-operational temperature limits	-40 to 65°C (-40 to 149°F)
Non-operational humidity limits	5% to 95% RH with 27°C (80.6°F) maximum dew point
Maximum non-operational altitude	12,000 meters (39,370 feet)
Maximum operational altitude	3,050 meters (10,000 feet)

**Table 27. Maximum vibration specifications**

Maximum vibration	Specifications
Operating	0.21 G <sub>rms</sub> at 5 Hz to 500 Hz for 10 minutes (all operation orientations)
Storage	1.88 G <sub>rms</sub> at 10 Hz to 500 Hz for 15 minutes (all six sides tested)

**Table 28. Maximum shock pulse specifications**

Maximum shock pulse	Specifications
Operating	Six consecutively executed shock pulses in the positive and negative x, y, and z axis of 6 G for up to 11 ms
Storage	Six consecutively executed shock pulses in the positive and negative x, y, and z axis (one pulse on each side of the system) of 71 G for up to 2 ms

## Particulate and gaseous contamination specifications

The following table defines the limitations that help avoid any equipment damage or failure from particulates and gaseous contamination. If the levels of particulates or gaseous pollution exceed the specified limitations and result in equipment damage or failure, you may need to rectify the environmental conditions. Remediation of environmental conditions is the responsibility of the customer.

**Table 29. Particulate contamination specifications**

Particulate contamination	Specifications
Air filtration	Data center air filtration as defined by ISO Class 8 per ISO 14644-1 with a 95% upper confidence limit <i>i</i> <b>NOTE:</b> This condition applies to data center environments only. Air filtration requirements do not apply to IT equipment designed to be used outside a data center, in environments such as an office or factory floor. <i>i</i> <b>NOTE:</b> Air entering the data center must have MERV11 or MERV13 filtration.
Conductive dust	Air must be free of conductive dust, zinc whiskers, or other conductive particles <i>i</i> <b>NOTE:</b> This condition applies to data center and non-data center environments.
Corrosive dust	<ul style="list-style-type: none"> <li>Air must be free of corrosive dust</li> <li>Residual dust present in the air must have a deliquescent point less than 60% relative humidity</li> </ul> <i>i</i> <b>NOTE:</b> This condition applies to data center and non-data center environments.
Walk-Up Edge Data Center or Cabinet (sealed, closed loop environment)	Filtration is not required for cabinets that are anticipated to be opened 6 times or less per year. Class 8 per ISO 1466-1 filtration as defined above is required otherwise <i>i</i> <b>NOTE:</b> In environments commonly above ISA-71 Class G1 or that may have known challenges, special filters may be required.

**Table 30. Gaseous contamination specifications**

Gaseous contamination	Specifications
Copper coupon corrosion rate	<300 Å/month per Class G1 as defined by ANSI/ISA71.04-2013
Silver coupon corrosion rate	<200 Å/month as defined by ANSI/ISA71.04-2013

## Thermal restriction matrix

**Table 31. Air cooling: Thermal restriction matrix(non-GPU)**

Configuration		No BP	8 x 2.5"	16 x 2.5" SAS	24 x 2.5" SAS			16x2.5" SAS + 8x2.5" U.2	24 x 2.5" NVM e	8x3.5"	12x3.5"		
Rear storage		No Rear Drives	No Rear Drives	No Rear Drives	No Rear Drives	2x Rear 2.5" w/ 2x Rear-Fan	4x Rear 2.5" w/ 3x Rear-Fan	No Rear Drives	No Rear Drives	No Rear Drives	No Rear Drives	2x Rear 2.5" w/ 2x Rear-Fan	4x Rear 2.5" w/ 3x Rear-Fan
CPU cTDP Max	CPU TDP												
CPU TDP / cTDP	240 W	210W	HPR Sliver Fan + 2U STD HSK			HPR Sliver Fan	HPR Sliver Fan	HPR Sliver Fan	HPR Gold Fan	HPR Sliver Fan [75%]	HPR Sliver Fan [70%]	HPR Gold Fan [70%] + 2U EXT HSK	
		200W				+ 2U EXT HSK	+ 2U STD HSK	+ 2U STD HSK	+ 2U STD HSK				

**Table 31. Air cooling: Thermal restriction matrix(non-GPU) (continued)**

Configuration		No BP	8 x 2.5"	16 x 2.5" SAS	24 x 2.5" SAS		16x2.5" SAS + 8x2.5" U.2	24 x 2.5" NVM e	8x3.5"	12x3.5"			
Rear storage		No Rear Drives	No Rear Drives	No Rear Drives	No Rear Drives	2x Rear 2.5" w/ 2x Rear-Fan	4x Rear 2.5" w/ 3x Rear-Fan	No Rear Drives	No Rear Drives	No Rear Drives	No Rear Drives	2x Rear 2.5" w/ 2x Rear-Fan	4x Rear 2.5" w/ 3x Rear-Fan
CPU cTDP Max	CPU TDP												
	300 W	260 W	HPR Sliver Fan + 2U EXT HSK		HPR Gold Fan	+ 2U EXT HSK	HPR Gold Fan	HPR Sliver Fan	HPR Gold Fan	HPR Sliver Fan [75%]	+ 2U EXT HSK	HPR Gold Fan [70%] + 2U EXT HSK *	
		290 W											
		280 W											
	400 W	360 W			HPR Gold Fan + 2U EXT HSK	HPR Gold Fan	+ 2U EXT HSK	HPR Gold Fan	HPR Gold Fan	HPR Gold Fan [75%]	+ 2U EXT HSK	Not supported	
		320 W											
	Memory	16GB RDIMM			HPR Sliver Fan								HPR Sliver Fan [75%]
32GB RDIMM		HPR Sliver Fan											
64GB RDIMM		HPR Sliver Fan											
128GB RDIMM		HPR GOLD Fan								HPR GOLD Fan [75%]	HPR GOLD Fan [70%]		
256GB RDIMM		HPR GOLD Fan								Supports 30°C ambient temperature	Supports 30°C ambient temperature		

**NOTE:** Standard supported operating temperature is 35°C.

\*Note: Supported ambient temperature is 30°C.

**NOTE:** Three fan modules are required for single processor, and six fan modules are required for dual processor system.

**Table 32. Air cooling: Thermal restriction matrix(GPU Configuration)**

Configuration				No BP	8 x 2.5-inch U.2	16 x 2.5-inch SAS	16 x 2.5-inch U.2	24 x 2.5-inch SAS			16 x 2.5-inch SAS + 8 x 2.5-inch U.2	8 x 3.5-inch
Rear storage				No Rear Drives	No Rear Drives	No Rear Drives	No Rear Drives	No Rear Drives	2x Rear 2.5" w/ 2x Rear-Fan	4x Rear 2.5 w/ 3x Rear-Fan	No Rear Drives	No Rear Drives
CPU cTDP Max	CPU TDP	Model										
CPU TDP/ cTDP	240W	210W	9334	HPR Gold Fan + 1U EXT HSK				Not Supported			HPR Gold Fan + 1U EXT HSK	HPR Gold Fan [75%] + 1U EXT HSK
		200W	9254									
	300 W	290 W	9224									
		280 W	9124									
			9634									
			9534									
			9454									
	9354											
	400 W	360 W	9654	HPR Gold Fan + 1U EXT HSK	Not Supported				Not Supported			Not Supported
			9554	HPR Gold Fan + 1U EXT HSK*								
			9474F	HPR Gold Fan + 1U EXT HSK								
		9374F	HPR Gold Fan + 1U EXT HSK									
		320 W	9274F	HPR Gold Fan + 1U EXT HSK								
			9174F	HPR Gold Fan + 1U EXT HSK								
Memory	16GB RDIMM			HPR Gold Fan				Not Supported			HPR Gold Fan	HPR Gold Fan
	32GB RDIMM											
	64GB RDIMM											
	128GB RDIMM											
	256GB RDIMM											
GPU	A2			HPR Gold Fan				Not Supported			HPR Gold Fan	HPR Gold Fan **
	A16 64GB											
	A30 24GB											
	A40 48GB											
	A100 80GB											HPR Gold Fan

**Table 32. Air cooling: Thermal restriction matrix(GPU Configuration) (continued)**

Configuration			No BP	8 x 2.5-inch U.2	16 x 2.5-inch SAS	16 x 2.5-inch U.2	24 x 2.5-inch SAS			16 x 2.5-inch SAS + 8 x 2.5-inch U.2	8 x 3.5-inch
Rear storage			No Rear Drives	No Rear Drives	No Rear Drives	No Rear Drives	No Rear Drives	2x Rear 2.5" w/ 2x Rear-Fan	4x Rear 2.5 w/ 3x Rear-Fan	No Rear Drives	No Rear Drives
CPU cTDP Max	CPU TDP	Model									
MI210 64GB											

\***Note:** Supported ambient temperature is 30°C.

\*\***Note:** Supported ambient temperature is 35°C.

**i** **NOTE:** “High-Performance Gold Fan” to be supported on all GPU configs.

**i** **NOTE:** GPU is not supported on 12 x 3.5-inch configs and system configs with rear module installed.

**Table 33. Air cooling: Thermal Guidance (non-GPU)**

Configuration				No BP	8 x 2.5" U.2	16 x 2.5" SAS	16 x 2.5" U.2	24 x 2.5" SAS		16 x 2.5" SAS + 8 x 2.5" U.2	8 x 3.5-inch	12 x 3.5-inch		
Rear storage				No Rear Drives	No Rear Drives	No Rear Drives	No Rear Drives	2 x Rear 2.5" w/ 2 x Rear fan	4 x Rear 2.5" w/ 3 x Rear fan	No Rear Drives	No Rear Drives	No Rear Drives	2 x Rear 2.5" w/ 2 x Rear fan	4 x Rear 2.5" w/ 3 x Rear fan
cTDP	Model	Core Count												
Shroud Type				Regular		Regular				Regular				
CPU TDP / cTDP	240 W	93 34	32	35°C	35°C	35°C	35°C	35°C	35°C	35°C	35°C	35°C	35°C	35°C
	240 W	92 24	24											
	240 W	92 54	24											
	240 W	912 4	16											
	300 W	96 34	84											
	300 W	95 34	48											
	300 W	94 54	64											
	300 W	93 54	32											
													30°C	

**Table 33. Air cooling: Thermal Guidance (non-GPU) (continued)**

Configuration				No BP	8 x 2.5" U.2	16 x 2.5" SAS	16 x 2.5" U.2	24 x 2.5" SAS		16 x 2.5" SAS + 8 x 2.5" U.2	8 x 3.5-inch	12 x 3.5-inch			
Rear storage				No Rear Drives	No Rear Drives	No Rear Drives	No Rear Drives	No Rear Drives	2 x Rear 2.5" w / 2 x Rear fan	4 x Rear 2.5" w / 3 x Rear fan	No Rear Drives	No Rear Drives	No Rear Drives	2 x Rear 2.5" w / 2 x Rear fan	4 x Rear 2.5" w / 3 x Rear fan
cTDP	Model	Core Count													
Shroud Type				Regular			Regular			Regular					
400 W	9654	96		35°C	35°C	35°C	35°C	35°C	35°C	35°C	35°C	35°C	35°C	35°C	35°C
	9554	64													
	9474F	48													
	9354F	32													
	9274F	21													
	9174F	16													
Memory	16GB RDIMM			35°C	35°C	35°C	35°C	35°C	35°C	35°C	35°C	35°C	35°C	35°C	35°C
	32GB RDIMM														
	64GB RDIMM														
	128GB RDIMM														
	256GB RDIMM														

**Table 34. Air cooling: Thermal Guidance (GPU configuration)**

Configuration				8 x 2.5" U.2		16 x 2.5" U.2		16 x 2.5" SAS		24x 2.5-inch SAS		8 x 3.5-inch	
GPU				DW (A100/A40/A30/A16/MI210)	SW A2	DW (A100/A40/A30/A16/MI210)	SW A2	DW (A100/A40/A30/A16/MI210)	SW A2	DW (A100/A40/A30/A16/MI210)	SW A2	DW (A100/A40/A30/A16/MI210)	SW A2
Max Qty				x3	x6	x3	x6	x3	x6	x3	x6	x2	x6
Shroud Type				GPU		GPU		GPU		GPU		GPU	
CPU TDP / cTDP	Model	Core Count	32	35°C	35°C	35°C	35°C	35°C	35°C	35°C	35°C	35°C	35°C

**Table 34. Air cooling: Thermal Guidance (GPU configuration) (continued)**

Configuration				8 x 2.5" U.2		16 x 2.5" U.2		16 x 2.5" SAS		24x 2.5-inch SAS		8 x 3.5-inch	
GPU				DW (A100/A40/A30/A16/MI210)	SW A2	DW (A100/A40/A30/A16/MI210)	SW A2	DW (A100/A40/A30/A16/MI210)	SW A2	DW (A100/A40/A30/A16/MI210)	SW A2	DW (A100/A40/A30/A16/MI210)	SW A2
Max Qty				x3	x6	x3	x6	x3	x6	x3	x6	x2	x6
Shroud Type				GPU		GPU		GPU		GPU		GPU	
	240 W	922 4	24										
	240 W	925 4	24										
	240 W	912 4	16										
	300 W	963 4	84										
	300 W	953 4	48										
	300 W	945 4/9 454 P	64										
	300 W	935 4/9 354 P	32										
	400 W	965 4/9 654 P	96										
	400 W	955 4/9 554 P	64										
	400 W	947 4F	48										
	400 W	935 4F	32	35°C									
	400 W	927 4F	21										
400 W	917 4F	16											

**NOTE:** GPU is not supported on 12 x 3.5-inch configs and system configs with rear module installed.

**NOTE:** Standard supported operating temperature is 35°C.

**NOTE:** "High-Performance GOLD Fan" to be supported on all GPU configs.

**NOTE:** GPU is not supported on 12 x 3.5-inch configs and system configs with rear module installed.



**Table 35. Label reference**

<b>Label</b>	<b>Description</b>
HPR (Silver)	High performance (silver grade)
HPR (Gold)	High performance (gold grade)
HSK	Heat sink
LP	Low profile
FH	Full height

## Thermal air restrictions

### ASHRAE A3 environment for air cooling configuration

- Two PSUs are required in redundant mode. If there is PSU failure, system performance may be reduced.
- Non-Dell qualified peripheral cards and peripheral cards greater than 25 W are not supported.
- GPU and FPGA are not supported.
- 128 GB, and higher capacity RDIMMs are not supported.
- PCIe SSD is not supported.
- Front storage is not supported in 12 x 3.5-inch SAS configuration.
- Rear drives are not supported.
- Processor TDP greater than or equal to 240 W are not supported.
- OCP card is supported with 85°C active optic cable.
- BOSS N1 is supported.

### ASHRAE A4 environment for air cooling configuration

- Two PSUs are required in redundant mode. If there is PSU failure, system performance may be reduced.
- Non-Dell qualified peripheral cards and peripheral cards greater than 25 W are not supported.
- GPU and FPGA are not supported.
- 128 GB, and higher capacity RDIMMs are not supported.
- PCIe SSD is not supported.
- Front storage is not supported in 12 x 3.5-inch SAS configuration.
- Rear drives are not supported.
- Processor TDP greater than or equal to 200 W are not supported.
- OCP card is not supported.
- BOSS N1 is not supported.

### ASHRAE A3 environment for liquid cooling configuration

- Two PSUs are required in redundant mode. If there is PSU failure, system performance may be reduced.
- Non-Dell qualified peripheral cards and peripheral cards greater than 25 W are not supported.
- GPU and FPGA are not supported.
- Intel Persistent memory 300 series, NVDIMM, 128 GB, or greater capacity DIMMs are not supported.
- PCIeSSD is not supported.
- Rear drives are not supported.
- HPR SLVR fans are required in 2.5-inch configurations systems.
- OCP card is supported with 85°C active optic cable.
- BOSS N1 is supported.

## ASHRAE A4 environment for liquid cooling configuration

- Two PSUs are required in redundant mode. If there is PSU failure, system performance may be reduced.
- Non-Dell qualified peripheral cards and peripheral cards greater than 25 W are not supported.
- GPU and FPGA are not supported.
- Intel Persistent memory 300 series, NVDIMM, 128 GB, or greater capacity DIMMs are not supported.
- PCIeSSD is not supported.
- Front storage is not supported in 12 x 3.5-inch SAS configuration.
- Rear drives are not supported.
- HPR SLVR fans are required in 2.5-inch configurations systems.
- OCP card is supported with 85°C active optic cable and cards tier  $\leq 4$ .
- BOSS N1 is not supported.

# Initial system setup and configuration

This section describes the tasks for initial setup and configuration of the Dell system. The section also provides general steps to set up the system and the reference guides for detailed information.

## Topics:

- [Setting up the system](#)
- [iDRAC configuration](#)
- [Options to download drivers and firmware](#)
- [Resources to install operating system](#)

## Setting up the system

Perform the following steps to set up the system:

### Steps

1. Unpack the system.
2. Install the system into the rack. For more information, see the rail installation and cable management accessory guides relevant to your rail and cable management solution at [www.dell.com/poweredgemanuals](http://www.dell.com/poweredgemanuals).
3. Connect the peripherals to the system and the system to the electrical outlet.
4. Power on the system by pressing the power button.

For more information about setting up the system, see the *Getting Started Guide* that is shipped with your system.


For information on how to manage basic settings and features of the system, see the Dell PowerEdge R7615 [Pre-operating system management applications](#) section.

## iDRAC configuration


The Integrated Dell Remote Access Controller (iDRAC) is designed to make you more productive as a system administrator and improve the overall availability of Dell servers. iDRAC alerts you to system issues, helps you to perform remote management, and reduces the need for physical access to the system.

### Options to set up iDRAC IP address

To enable communication between your system and iDRAC, you must first configure the network settings based on your network infrastructure. The network settings option is set to **DHCP**, by default.

 **NOTE:** For static IP configuration, you must request for the settings at the time of purchase.

You can set up the iDRAC IP address using one of the interfaces in the table below. For information about setting up iDRAC IP address, see the documentation links provided in the table below.

 **NOTE:** To access iDRAC, ensure that you connect the ethernet cable to the iDRAC dedicated network port or use the iDRAC Direct port by using the micro USB (type AB) cable.

### Options to log in to iDRAC

To log in to the iDRAC Web User Interface, open a browser and enter the IP address.


You can log in to iDRAC as:

- iDRAC user
- Microsoft Active Directory user
- Lightweight Directory Access Protocol (LDAP) user

In the login screen displayed, if you have opted for secure default access to iDRAC, the default username is `root` and enter the iDRAC secure default password available on back of the Information Tag. If you opted for legacy password, use the iDRAC legacy username and password - `root` and `calvin`, the iDRAC default password will be blank on the information tag. Then you will be prompted and required to create a password of your choice before proceeding. You can also log in by using your Single Sign-On or Smart Card.

 **NOTE:** Ensure that you change the default username and password after setting up the iDRAC IP address.

For more information about logging in to the iDRAC and iDRAC licenses, see the latest *Integrated Dell Remote Access Controller User's Guide* at [www.dell.com/idracmanuals](http://www.dell.com/idracmanuals).

 **NOTE:** To determine the most recent iDRAC release for your platform and for latest documentation version, see KB article <https://www.dell.com/support/article/sln308699>.

You can also access iDRAC using command-line protocol - RACADM. For more information, see the *Integrated Dell Remote Access Controller RACADM CLI Guide* available at <https://www.dell.com/idracmanuals>.

You can also access iDRAC using automation tool - Redfish API. For more information, see the *Integrated Dell Remote Access Controller User's Guide Redfish API Guide* available at <https://developer.dell.com>.



## Options to download drivers and firmware

You can download drivers and firmware from the FTP site: <https://mft.dell.com/R7615>. For more information about username and password, contact your TAM (Tech Account Manager).

## Resources to install operating system

If the system is shipped without an operating system, you can install a supported operating system by using one of the resources provided in the table below. For information about how to install the operating system, see the documentation links provided in the table below.

**Table 36. Resources to install the operating system**

Resource	Documentation links
iDRAC	<i>Integrated Dell Remote Access Controller User's Guide</i> at <a href="https://www.dell.com/idracmanuals">https://www.dell.com/idracmanuals</a> or for system specific <i>Integrated Dell Remote Access Controller User's Guide</i> , go to <a href="https://www.dell.com/poweredgemanuals">https://www.dell.com/poweredgemanuals</a> > <b>Product Support</b> page of your system > <b>Documentation</b> .  <b>NOTE:</b> To determine the most recent iDRAC release for your platform and for latest documentation version, see KB article at <a href="https://www.dell.com/support/article/sln308699">https://www.dell.com/support/article/sln308699</a> .
Lifecycle Controller	<i>Dell Lifecycle Controller User's Guide</i> at <a href="https://www.dell.com/idracmanuals">https://www.dell.com/idracmanuals</a> or for system specific <i>Dell Lifecycle Controller User's Guide</i> , go to <a href="https://www.dell.com/poweredgemanuals">https://www.dell.com/poweredgemanuals</a> > <b>Product Support</b> page of your system > <b>Documentation</b> . Dell recommends using Lifecycle Controller to install the OS, since all required drivers are installed on the system.  <b>NOTE:</b> To determine the most recent iDRAC release for your platform and for latest documentation version, see KB article at <a href="https://www.dell.com/support/article/sln308699">https://www.dell.com/support/article/sln308699</a> .

# Pre-operating system management applications

You can manage basic settings and features of a system without booting to the operating system by using the system firmware.

## Options to manage the pre-operating system applications

You can use any one of the following options to manage the pre-operating system applications:

- System Setup
- Dell Lifecycle Controller
- Boot Manager
- Preboot Execution Environment (PXE)

### Topics:

- [System Setup](#)
- [Dell Lifecycle Controller](#)
- [Boot Manager](#)
- [PXE boot](#)


## System Setup

Using the **System Setup** option, you can configure the BIOS settings, iDRAC settings, and device settings of the system.

You can access system setup by using any one of the following interfaces:

- Graphical User interface — To access go to iDRAC Dashboard, click **Configuration**, and click **BIOS Settings**.
- Text browser — The browser is enabled by using Console Redirection.

To view **System Setup**, power on the system, press F2, and click **System Setup Main Menu**.

 **NOTE:** If the operating system begins to load before you press F2, wait for the system to finish booting, and then restart the system and try again.

The **System Setup Main Menu** screen details are described as follows:


**Table 37. System Setup Main Menu**

Option	Description
<b>System BIOS</b>	Enables you to configure the BIOS settings.
<b>iDRAC Settings</b>	Enables you to configure the iDRAC settings. The iDRAC settings utility is an interface to set up and configure the iDRAC parameters by using UEFI (Unified Extensible Firmware Interface). You can enable or disable various iDRAC parameters by using the iDRAC settings utility. For more information about this utility, see <i>Integrated Dell Remote Access Controller User's Guide</i> at <a href="http://www.dell.com/poweredgemanuals">www.dell.com/poweredgemanuals</a> .
<b>Device Settings</b>	Enabled you to configure device settings for devices such as storage controllers or network cards.

## System BIOS

To view the **System BIOS** screen, power on the system, press F2, and click **System Setup Main Menu > System BIOS**.

**Table 38. System BIOS details**

Option	Description
<b>System Information</b>	Provides information about the system such as the system model name, BIOS version, and Service Tag.
<b>Memory Settings</b>	Specifies information and options related to the installed memory.
<b>Processor Settings</b>	Specifies information and options related to the processor such as speed and cache size.
<b>SATA Settings</b>	Specifies options to enable or disable the integrated SATA controller and ports.
<b>NVMe Settings</b>	Specifies options to change the NVMe settings. If the system contains the NVMe drives that you want to configure in a RAID array, you must set both this field and the <b>Embedded SATA</b> field on the <b>SATA Settings</b> menu to <b>RAID</b> mode. You might also need to change the <b>Boot Mode</b> setting to <b>UEFI</b> . Otherwise, you should set this field to <b>Non-RAID</b> mode.
<b>Boot Settings</b>	Specifies options to specify the Boot mode (BIOS or UEFI). Enables you to modify UEFI and BIOS boot settings.
<b>Network Settings</b>	Specifies options to manage the UEFI network settings and boot protocols.  Legacy network settings are managed from the <b>Device Settings</b> menu.   <b>NOTE:</b> Network Settings are not supported in BIOS boot mode.
<b>Integrated Devices</b>	Specifies options to manage integrated device controllers and ports, specifies related features, and options.
<b>Serial Communication</b>	Specifies options to manage the serial ports, its related features, and options.
<b>System Profile Settings</b>	Specifies options to change the processor power management settings, memory frequency.
<b>System Security</b>	Specifies options to configure the system security settings, such as system password, setup password, Trusted Platform Module (TPM) security, and UEFI secure boot. It also manages the power button on the system
<b>Redundant OS Control</b>	Sets the redundant OS information for redundant OS control.
<b>Miscellaneous Settings</b>	Specifies options to change the system date and time.

## System Information

To view the **System Information** screen, power on the system, press F2, and click **System Setup Main Menu > System BIOS > System Information**.

**Table 39. System Information details**

Option	Description
<b>System Model Name</b>	Specifies the system model name.
<b>System BIOS Version</b>	Specifies the BIOS version installed on the system.
<b>System Service Tag</b>	Specifies the system Service Tag.
<b>System Manufacturer</b>	Specifies the name of the system manufacturer.
<b>System Manufacturer Contact Information</b>	Specifies the contact information of the system manufacturer.

**Table 39. System Information details (continued)**

Option	Description
<b>System CPLD Version</b>	Specifies the current version of the system complex programmable logic device (CPLD) firmware.
<b>UEFI Compliance Version</b>	Specifies the UEFI compliance level of the system firmware.
<b>AGESA Version</b>	Specifies the AGESA reference code version.
<b>SMU Version</b>	Specifies the SMU firmware version.
<b>MPIO Version</b>	Specifies the MPIO firmware version.

## Memory Settings

To view the **Memory Settings** screen, power on the system, press F2, and click **System Setup Main Menu > System BIOS > Memory Settings**.

**Table 40. Memory Settings details**

Option	Description
<b>System Memory Size</b>	Specifies the memory size in the system.
<b>System Memory Type</b>	Specifies the type of memory installed in the system.
<b>System Memory Speed</b>	Specifies the system memory speed.
<b>Video Memory</b>	Specifies the amount of video memory.
<b>System Memory Testing</b>	Specifies whether the system memory tests are run during system boot. The two options available are <b>Enabled</b> and <b>Disabled</b> . This option is set to <b>Disabled</b> by default.
<b>DRAM Refresh Delay</b>	By enabling the <b>CPU memory controller</b> to delay running the <b>REFRESH</b> commands, you can improve the performance for some workloads. By minimizing the delay time, it is ensured that the memory controller runs the <b>REFRESH</b> command at regular intervals. For Intel-based servers, this setting only affects systems configured with DIMMs which use 8 Gb density DRAMs. This option is set to <b>Minimum</b> by default.
<b>DIMM Self Healing(Post Package Repair) on Uncorrectable Memory Error</b>	Enables or disables Post Package Repair (PPR) on Uncorrectable Memory Error. This option is set to <b>Enabled</b> by default.
<b>Correctable Error Logging</b>	Enables or disables correctable error logging. This option is set to <b>Disabled</b> by default.

## Processor Settings

To view the **Processor Settings** screen, power on the system, press F2, and click **System Setup Main Menu > System BIOS > Processor Settings**.

**Table 41. Processor Settings details**

Option	Description
<b>Logical Processor</b>	Each processor core supports up to two logical processors. If this option is set to <b>Enabled</b> , the BIOS displays all the logical processors. If this option is set to <b>Disabled</b> , the BIOS displays only one logical processor per core. This option is set to <b>Enabled</b> by default.
<b>Virtualization Technology</b>	Enables or disables the virtualization technology for the processor. This option is set to <b>Enabled</b> by default.

**Table 41. Processor Settings details (continued)**

Option	Description
<b>IOMMU Support</b>	Enable or Disable IOMMU support. It is required to create IVRS ACPI table. This option is set to <b>Enabled</b> by default.
<b>Kernel DMA Protection</b>	When this option is set to Enabled, using IOMMU, BIOS, and the Operating System will enable direct memory access protection for DMA capable peripheral devices. Enable <b>IOMMU Support</b> to use this option. This option is set to <b>Disabled</b> by default. When set to Enabled by using Virtualization Technology, BIOS and Operating System will enable direct memory access protection for DMA capable peripheral devices. Enable Virtualization Technology to use this option.
<b>L1 Stream HW Prefetcher</b>	Enables or disables the L1 stream hardware prefetcher. This option is set to <b>Enabled</b> by default.
<b>L2 Stream HW Prefetcher</b>	Enables or disables the L2 stream hardware prefetcher. This option is set to <b>Enabled</b> by default.
<b>L1 Stride Prefetcher</b>	Enables or disables the L1 stride prefetcher. This option is set to <b>Enabled</b> by default, as it optimizes overall workload. <b>i</b> <b>NOTE:</b> This option is only available for 4 <sup>th</sup> Generation AMD EPYC processors.
<b>L1 Region Prefetcher</b>	Enables or disables the L1 region prefetcher. This option is set to <b>Enabled</b> by default, as it optimizes overall workload. <b>i</b> <b>NOTE:</b> This option is only available for 4 <sup>th</sup> Generation AMD EPYC processors.
<b>L2 Up Down Prefetcher</b>	Enables or disables the L2 up down prefetcher. This option is set to <b>Enabled</b> by default, as it optimizes overall workload. <b>i</b> <b>NOTE:</b> This option is only available for 4 <sup>th</sup> Generation AMD EPYC processors.
<b>MADT Core Enumeration</b>	Specifies the MADT Core Enumeration. This option is set to <b>Linear</b> by default.
<b>NUMA Nodes Per Socket</b>	Specifies the number of NUMA nodes per socket. This option is set to <b>1</b> by default.
<b>L3 cache as NUMA Domain</b>	Enables or disables the as NUMA Domain. This option is set to <b>Disabled</b> by default.
<b>Secure Memory Encryption</b>	Enables or disables the AMD secure encryption features such as <b>SME</b> and <b>Secure Encrypted Virtualization (SEV)</b> . It also determines if other secure encryption features such as <b>TSME</b> and <b>SEV-SNP</b> can be enabled. This option is set to <b>Disabled</b> by default. <b>i</b> <b>NOTE:</b> This option is only available for 4 <sup>th</sup> Generation AMD EPYC processors.
<b>Minimum SEV non-ES ASID</b>	Determines the number of Secure Encrypted Virtualization ES and non-ES available Address Space IDs. This option is set to <b>1</b> by default.
<b>Transparent Secure Memory Encryption</b>	Enables or disables the <b>TSME</b> . <b>TSME</b> is always-on memory encryption that does not require OS or hypervisor support. This option is set to <b>Disabled</b> by default. <ul style="list-style-type: none"> <li>• If the OS supports <b>SME</b>, do not enable this field.</li> <li>• If the hypervisor supports <b>SEV</b>, do not enable this field.</li> </ul> Enabling <b>TSME</b> affects the system memory performance.



**Table 41. Processor Settings details (continued)**

Option	Description
<b>Configurable TDP</b>	Allows the reconfiguration of the processor Thermal Design Power (TDP) levels based on the power and thermal delivery capabilities of the system. TDP refers to the maximum amount of power the cooling system is required to dissipate. This option is set to <b>Maximum</b> by default. <b>i</b> <b>NOTE:</b> This option is only available on certain SKUs of the processors, and the number of alternative levels varies as well.
<b>x2APIC Mode</b>	Enables or disables x2APIC mode. This option is set to <b>Enabled</b> by default. <b>i</b> <b>NOTE:</b> For two CPU 64 cores configuration, x2APIC mode is not switchable if 256 threads are enabled (BIOS settings: All CCD, cores, and logical processors enabled).
<b>Number of CCDs per Processor</b>	Controls the number of enabled CCDs in each processor. This option is set to <b>All</b> by default.
<b>Number of Cores per CCD</b>	Specifies the number of cores per CCD. This option is set to <b>All</b> by default.
<b>Processor Core Speed</b>	Specifies the maximum core frequency of the processor.
<b>Processor n</b>	<b>i</b> <b>NOTE:</b> Depending on the number of CPUs, there might be up to n processors listed.  The following settings are displayed for each processor that is installed in the system:

**Table 42. Processor n details**

Option	Description
<b>Family-Model-Stepping</b>	Specifies the family, model, and stepping of the processor as defined by AMD.
<b>Brand</b>	Specifies the brand name.
<b>Level 2 Cache</b>	Specifies the total L2 cache.
<b>Level 3 Cache</b>	Specifies the total L3 cache.
<b>Number of Cores</b>	Specifies the number of cores per processor.
<b>Microcode</b>	Specifies the processor microcode version.

## SATA Settings

To view the **SATA Settings** screen, power on the system, press F2, and click **System Setup Main Menu > System BIOS > SATA Settings**.

**Table 43. SATA Settings details**

Option	Description
<b>Embedded SATA</b>	Enables the embedded SATA option to be set to <b>Off</b> , <b>AHCI mode</b> , or <b>RAID modes</b> . This option is set to <b>AHCI Mode</b> by default. <b>i</b> <b>NOTE:</b> <ol style="list-style-type: none"> <li>You might also need to change the Boot Mode setting to UEFI. Otherwise, you should set the field to Non-RAID mode.</li> <li>No ESXi and Ubuntu OS support under RAID mode.</li> </ol>

**Table 43. SATA Settings details (continued)**

Option	Description
<b>Security Freeze Lock</b>	Sends <b>Security Freeze Lock</b> command to the embedded SATA drives during POST. This option is applicable only for AHCI Mode. This option is set to <b>Enabled</b> by default.
<b>Write Cache</b>	Enables or disables the command for the embedded SATA drives during POST. This option is set to <b>Disabled</b> by default.

## NVMe Settings

To view the **NVMe Settings** screen, power on the system, press F2, and click **System Setup Main Menu > System BIOS > NVMe Settings**

**Table 44. NVMe Settings details**

Option	Description
<b>NVMe Mode</b>	This option sets the NVMe drive mode. If the system contains NVMe drives that you want to configure in a RAID array, you must set both this field and the Embedded SATA field on the SATA settings menu to RAID Mode. You may also need to change the Boot Mode setting to UEFI. The option is set to <b>Non-RAID</b> mode by default.
<b>BIOS NVMe Driver</b>	Dell Qualified NVMe drives always use the UEFI NVMe driver built into the Dell EROS. When this option is set to 'All Drives', the BIOS driver will also be used with any NVMe drives in the system that has not been qualified by Dell. The option is set to <b>Dell Qualified Drives</b> by default. <i>i</i> <b>NOTE:</b> When this option is set to 'All Drives' and non-Dell qualified NVMe drives are present, you have a configuration that has not been validated which may lead to unexpected behavior.

## Boot Settings

You can use the **Boot Settings** screen to set the boot mode to either **BIOS** or **UEFI**. It also enables you to specify the boot order.


- **UEFI:** The Unified Extensible Firmware Interface (UEFI) is a new interface between operating systems and platform firmware. The interface consists of data tables with platform related information, boot and runtime service calls that are available to the operating system and its loader. The following benefits are available when the **Boot Mode** is set to **UEFI**:
  - Support for drive partitions larger than 2 TB.
  - Enhanced security (e.g., UEFI Secure Boot).
  - Faster boot time.

*i* **NOTE:** You must use only the UEFI boot mode in order to boot from NVMe drives.


- **BIOS:** The **BIOS Boot Mode** is the legacy boot mode. It is maintained for backward compatibility.

To view the **Boot Settings** screen, power on the system, press F2, and click **System Setup Main Menu > System BIOS > Boot Settings**.

**Table 45. Boot Settings details**


Option	Description
<b>Boot Mode</b>	Enables you to set the boot mode of the system. If the operating system supports UEFI, you can set this option to UEFI. Setting this field to BIOS allows compatibility with non-UEFI operating systems. This option is set to <b>UEFI</b> by default.  <b>CAUTION: Switching the boot mode may prevent the system from booting if the operating system is not installed in the same boot mode.</b> <i>i</i> <b>NOTE:</b> Setting this field to UEFI disables the <b>BIOS Boot Settings</b> menu.


**Table 45. Boot Settings details (continued)**


Option	Description						
<b>Boot Sequence Retry</b>	Enables or disables the <b>Boot Sequence Retry</b> feature. If this option is set to <b>Enabled</b> and the system fails to boot, the system re-attempts the boot sequence after 30 seconds. This option is set to <b>Enabled</b> by default.						
<b>Hard Disk Failover</b>	Enables or disables the Hard-disk failover. This option is set to <b>Disabled</b> by default.						
<b>Generic USB Boot</b>	Enables or disables the generic USB boot placeholder. This option is set to <b>Disabled</b> by default.						
<b>Hard-disk Drive Placeholder</b>	Enables or disables the Hard-disk drive placeholder. This option is set to <b>Disabled</b> by default.						
<b>Clean all SysPrep variables and order</b>	When set to <b>None</b> , BIOS will do nothing. When set to <b>Yes</b> , BIOS will delete variables of SysPrep ##### and SysPrepOrder this option is a onetime option, will reset to none when deleting variables. This setting is only available in <b>UEFI Boot Mode</b> . This option is set to <b>None</b> by default.						
<b>UEFI Boot Settings</b>	<p>Specifies the UEFI boot sequence. Enables or disables UEFI Boot options.</p> <p> <b>NOTE:</b> This option controls the UEFI boot order. The first option in the list will be attempted first.</p> <p><b>Table 46. UEFI Boot Settings</b></p> <table border="1"> <thead> <tr> <th>Option</th> <th>Description</th> </tr> </thead> <tbody> <tr> <td><b>UEFI Boot Sequence</b></td> <td>Enables you to change the boot device order.</td> </tr> <tr> <td><b>Boot Option Enable/Disable</b></td> <td>Enables you to select the enabled or disabled boot devices</td> </tr> </tbody> </table>	Option	Description	<b>UEFI Boot Sequence</b>	Enables you to change the boot device order.	<b>Boot Option Enable/Disable</b>	Enables you to select the enabled or disabled boot devices
Option	Description						
<b>UEFI Boot Sequence</b>	Enables you to change the boot device order.						
<b>Boot Option Enable/Disable</b>	Enables you to select the enabled or disabled boot devices						

## Choosing system boot mode

System Setup enables you to specify one of the following boot modes for installing your operating system:

- UEFI boot mode (the default), is an enhanced 64-bit boot interface. If you have configured your system to boot to UEFI mode, it replaces the system BIOS.
- From the **System Setup Main Menu**, click **Boot Settings**, and select **Boot Mode**.
  - Select the UEFI boot mode you want the system to boot into.
-  **CAUTION: Switching the boot mode may prevent the system from booting if the operating system is not installed in the same boot mode.**
- After the system boots in the specified boot mode, proceed to install your operating system from that mode.


 **NOTE:** Operating systems must be UEFI-compatible to be installed from the UEFI boot mode. DOS and 32-bit operating systems do not support UEFI and can only be installed from the BIOS boot mode.

 **NOTE:** For the latest information about supported operating systems, go to [www.dell.com/ossupport](http://www.dell.com/ossupport).

## Changing boot order

### About this task


You may have to change the boot order if you want to boot from a USB key or an optical drive. The following instructions may vary if you have selected **BIOS** for **Boot Mode**.

 **NOTE:** Changing the drive boot sequence is only supported in BIOS boot mode.

### Steps


- On the **System Setup Main Menu** screen, click **System BIOS > Boot Settings > UEFI Boot Settings > UEFI Boot Sequence**.


- Use the arrow keys to select a boot device, and use the plus (+) and minus (-) sign keys to move the device down or up in the order.
- Click **Exit**, and then click **Yes** to save the settings on exit.

 **NOTE:** You can also enable or disable boot order devices as needed.

## Network Settings

To view the **Network Settings** screen, power on the system, press F2, and click **System Setup Main Menu > System BIOS > Network Settings**.

 **NOTE:** For information about Linux network performance settings, see the *Linux Network Tuning Guide for AMD EPYC Processor Based Servers* at [AMD.com](https://www.amd.com).

 **NOTE:** Network Settings are not supported in BIOS boot mode.

**Table 47. Network Settings details**

Option	Description
<b>UEFI PXE Settings</b>	Enables you to control the configuration of the UEFI PXE device.
<b>Number of PXE Devices</b>	Enables you to choose the number of PXE Devices from 1 to 4, 8, 12, 16.
<b>PXE Device n</b> (n = 1 to 16)	Enables or disables the device. When enabled, a UEFI PXE boot option is created for the device.
<b>PXE Device n Settings</b> (n = 1 to 16)	Enables you to control the configuration of the PXE device.
<b>UEFI HTTP Settings</b>	Enables you to control the configuration of the UEFI HTTP device.
<b>HTTP Device n</b> (n = 1 to 4)	Enables or disables the device. When enabled, a UEFI HTTP boot option is created for the device.
<b>HTTP Device n Settings</b> (n = 1 to 4)	Enables you to control the configuration of the HTTP device.
<b>UEFI ISCSI Settings</b>	Enables you to control the configuration of the ISCSI device.
<b>UEFI NVMe-oF Settings</b>	Enables you to control the configuration of the NVMe-oF device.

**Table 48. PXE Device n Settings details**

Option	Description
<b>Interface</b>	Specifies NIC interface used for the PXE device.
<b>Protocol</b>	Specifies Protocol used for PXE device. This option is set to <b>IPv4</b> or <b>IPv6</b> . This option is set to <b>IPv4</b> by default.
<b>VLAN</b>	Enables VLAN for PXE device. This option is set to <b>Enable</b> or <b>Disable</b> . This option is set to <b>Disable</b> by default.
<b>VLAN ID</b>	Shows the VLAN ID for the PXE device
<b>VLAN Priority</b>	Shows the VLAN Priority for the PXE device.

**Table 49. HTTP Device n Settings details**

Option	Description
<b>Interface</b>	Specifies NIC interface used for the HTTP device.
<b>Protocol</b>	Specifies Protocol used for HTTP device. This option is set to <b>IPv4</b> or <b>IPv6</b> . This option is set to <b>IPv4</b> by default.  The following options will be available when Protocol is set as IPv6:  <b>Auto Configuration:</b> IPv6 Auto Configuration Enable/Disabled for this HTTP Device.  <b>IPv6 Address:</b> IPv6 Unicast address for this HTTP Device.

**Table 49. HTTP Device n Settings details (continued)**

Option	Description
	<b>Prefix Length:</b> IPv6 Prefix Length (0-128) for this HTTP Device.
<b>VLAN</b>	Enables VLAN for HTTP device. This option is set to <b>Enable</b> or <b>Disable</b> . This option is set to <b>Disable</b> by default.
<b>VLAN ID</b>	Shows the VLAN ID for the HTTP device
<b>VLAN Priority</b>	Shows the VLAN Priority for the HTTP device.
<b>DHCP</b>	Enables or disables DHCP for this HTTP device. This option is set to <b>Enable</b> by default.
<b>IP Address</b>	Specifies IP address for the HTTP device.
<b>Subnet Mask</b>	Specifies subnet mask for the HTTP device.
<b>Gateway</b>	Specifies gateway for the HTTP device.
<b>DNS info via DHCP</b>	Enables or disables DNS Information from DHCP. This option is set to <b>Enable</b> by default.
<b>Primary DNS</b>	Specifies the primary DNS server IP address for the HTTP Device.
<b>Secondary DNS</b>	Specifies the secondary DNS server IP address for the HTTP Device.
<b>URI (will obtain from DHCP server if not specified)</b>	The URI will be obtained from the DHCP server if not specified.
<b>TLS Authentication Configuration</b>	View and/or modify this device's boot TLS authentication configuration.

**Table 50. UEFI ISCSI Settings screen details**

Option	Description
<b>ISCSI Initiator Name</b>	Specifies the name of the ISCSI initiator in IQN format.
<b>ISCSI Device1</b>	Enables or disables the ISCSI device. When disabled, a UEFI boot option is created for the ISCSI device automatically. This is set to <b>Disabled</b> by default.
<b>ISCSI Device1 Settings</b>	Enables you to control the configuration of the ISCSI device.

**Table 51. ISCSI Device1 Settings screen details**

Option	Description
<b>Connection 1</b>	Enables or disables the ISCSI connection. This option is set to <b>Disable</b> by default.
<b>Connection 2</b>	Enables or disables the ISCSI connection. This option is set to <b>Disable</b> by default.
<b>Connection 1 Settings</b>	Enables you to control the configuration for the ISCSI connection.
<b>Connection 2 Settings</b>	Enables you to control the configuration for the ISCSI connection.
<b>Connection Order</b>	Enables you to control the order for which the ISCSI connections will be attempted.

**Table 52. UEFI NVMe-oF Settings screen details**

Option	Description
<b>NVMe-oF</b>	Enables or disables the NVMe-oF device. When disabled, a UEFI boot option is created for the NVMe-oF device automatically. This is set to <b>Disabled</b> by default.
<b>NVMe-oF Host NQN</b>	Specifies Host NQN of the NVMe-oF device.
<b>NVMe-oF Host Id</b>	Specifies Host Id of the NVMe-oF device.
<b>Host Security Key Path</b>	Specifies Host Security Key Path of the NVMe-oF device.
<b>NVMe-oF SubSystem Settings</b>	Enables you to control the configuration of the NVMe-oF device.


## Integrated Devices

To view the **Integrated Devices** screen, power on the system, press F2, and click **System Setup Main Menu > System BIOS > Integrated Devices**.

**Table 53. Integrated Devices details**

Option	Description
<b>User Accessible USB Ports</b>	<p>Configures the user accessible USB ports. Selecting <b>Only Back Ports On</b> disables the front USB ports; selecting <b>All Ports Off</b> disables all front and back USB ports; selecting <b>All Ports Off (Dynamic)</b> disables all front and back USB ports during POST. This option is set to <b>All Ports On</b> by default. When user accessible USB ports is set to <b>All Ports Off (Dynamic)</b> the <b>Enable Front Ports Only</b> option is enabled.</p> <ul style="list-style-type: none"> <li>• <b>Enable Front Ports Only:</b> Enables or disables the front USB ports during the OS runtime.</li> </ul> <p>The USB keyboard and mouse still function in certain USB ports during the boot process, depending on the selection. After the boot process is complete, the USB ports will be enabled or disabled as per the setting.</p>
<b>Internal USB Port</b>	<p>Enables or disables the <b>Internal USB Port</b>. This option is set to <b>On</b> or <b>Off</b>. This option is set to <b>On</b> by default.</p>
<b>iDRAC Direct USB Port</b>	<p>The iDRAC Direct USB port is managed by iDRAC exclusively with no host visibility. This option is set to <b>ON</b> or <b>OFF</b>. When set to <b>OFF</b>, iDRAC does not detect any USB devices installed in this managed port. This option is set to <b>On</b> by default. Enables or disables the integrated RAID controller. When set to <b>Disabled</b>, the device is not visible to the operating system(OS). Enables or disables the integrated RAID controller. When set to <b>Disabled</b>, the device is not visible to the operating system(OS).</p>
<b>Integrated RAID Controller</b>	<p>Enables or disables the integrated RAID controller. When set to <b>Disabled</b>, the device is not visible to the operating system(OS).</p>
<b>Embedded NIC1 and NIC2</b>	<p>Enables or disables the <b>Embedded NIC1 and NIC2</b> options. If set to <b>Disabled (OS)</b>, the NIC may still be available for shared network access by the embedded management controller. Configure the <b>Embedded NIC1 and NIC2</b> option by using the NIC management utilities of the system.</p>
<b>Embedded Video Controller</b>	<p>Enables or disables the use of Embedded Video Controller as the primary display. When set to <b>Enabled</b>, the Embedded Video Controller will be the primary display even if add-in graphic cards are installed. When set to <b>Disabled</b>, an add-in graphics card will be used as the primary display. BIOS will output displays to both the primary add-in video and the embedded video during POST and pre-boot environment. The embedded video will then be disabled right before the operating system boots. This option is set to <b>Enabled</b> by default.</p> <p><b>NOTE:</b> When there are multiple add-in graphic cards installed in the system, the first card discovered during PCI enumeration is selected as the primary video. You might have to re-arrange the cards in the slots in order to control which card is the primary video.</p>
<b>Current State of Embedded Video Controller</b>	<p>Displays the current state of the embedded video controller. The <b>Current State of Embedded Video Controller</b> option is a read-only field. If the Embedded Video Controller is the only display capability in the system (that is, no add-in graphics card is installed), then the Embedded Video Controller is automatically used as the primary display even if the <b>Embedded Video Controller</b> setting is set to <b>Disabled</b>.</p>
<b>SR-IOV Global Enable</b>	<p>Enables or disables the BIOS configuration of Single Root I/O Virtualization (SR-IOV) devices. This option is set to <b>Disabled</b> by default.</p>
<b>OS Watchdog Timer</b>	<p>If your system stops responding, this watchdog timer aids in the recovery of your operating system. When this option is set to <b>Enabled</b>, the operating</p>





**Table 53. Integrated Devices details (continued)**

Option	Description
	system initializes the timer. When this option is set to <b>Disabled</b> (the default), the timer does not have any effect on the system.
<b>Memory Mapped I/O Limit</b>	Controls where MMIO is mapped. The <b>1 TB</b> option is designed for specific OS which cannot support MMIO over 1 TB. This option is set to <b>8 TB</b> by default. The default option is the maximum address that the system supports and recommended in most cases.
<b>Slot Disablement</b>	Enables or disables the available PCIe slots on your system. The slot disablement feature controls the configuration of the PCIe cards installed in the specified slot. Slots must be disabled only when the installed peripheral card prevents booting into the operating system or causes delays in system startup. If the slot is disabled, both the Option ROM and UEFI drivers are disabled. Only slots that are present on the system will be available for control. <b>Slot n:</b> Enables or disables or only the boot driver is disabled for the PCIe slot n. This option is set to <b>Enabled</b> by default.
<b>Slot Bifurcation</b>	<b>Slot Discovery Bifurcation Settings</b> allows <b>Platform Default Bifurcation</b> and <b>Manual bifurcation Control</b> . The default is set to <b>Platform Default Bifurcation</b> . The slot bifurcation field is accessible when set to <b>Manual bifurcation Control</b> and is grayed out when set to <b>Platform Default Bifurcation</b> .  <b>NOTE:</b> This option is only available for 4 <sup>th</sup> Generation AMD EPYC processors.

## Serial Communication

To view the **Serial Communication** screen, power on the system, press F2, and click **System Setup Main Menu > System BIOS > Serial Communication**.

**Table 54. Serial Communication details**

Option	Description
<b>Serial Communication</b>	Selects serial communication devices (Serial Device 1 and Serial Device 2) in BIOS. BIOS console redirection can also be enabled and the port address can be specified. This option is set to <b>Auto</b> by default.
<b>Serial Port Address</b>	Enables you to set the port address for serial devices.  <b>NOTE:</b> You can use only Serial Device 2 for the Serial Over LAN (SOL) feature. To use console redirection by SOL, configure the same port address for console redirection and the serial device.  <b>NOTE:</b> Every time the system boots, the BIOS syncs the serial MUX setting that is saved in iDRAC. The serial MUX setting can independently be changed in iDRAC. Loading the BIOS default settings from within the BIOS setup utility may not always revert the serial MUX setting to the default setting of Serial Device 1.
<b>External Serial Connector</b>	Enables you to associate the External Serial Connector to <b>Serial Device 1</b> , <b>Serial Device 2</b> , or the <b>Remote Access Device</b> by using this option. This option is set to <b>Serial Device 1</b> by default.  <b>NOTE:</b> Only Serial Device 2 can be used for Serial Over LAN (SOL). To use console redirection by SOL, configure the same port address for console redirection and the serial device.  <b>NOTE:</b> Every time the system boots, the BIOS syncs the serial MUX setting saved in iDRAC. The serial MUX setting can independently be changed in iDRAC. Loading the BIOS default settings from within the BIOS

**Table 54. Serial Communication details (continued)**

Option	Description
	setup utility may not always revert this setting to the default setting of Serial Device 1.
<b>Failsafe Baud Rate</b>	Specifies the failsafe baud rate for console redirection. The BIOS attempts to determine the baud rate automatically. This failsafe baud rate is used only if the attempt fails, and the value must not be changed. This option is set to <b>115200</b> by default.
<b>Remote Terminal Type</b>	Sets the remote console terminal type. This option is set to <b>VT100/VT220</b> by default.
<b>Redirection After Boot</b>	Enables or disables the BIOS console redirection when the operating system is loaded. This option is set to <b>Enabled</b> by default.

## System Profile Settings

To view the **System Profile Settings** screen, power on the system, press F2, and click **System Setup Main Menu > System BIOS > System Profile Settings**.

**Table 55. System Profile Settings details**

Option	Description
<b>System Profile</b>	Sets the system profile. If you set the System Profile option to a mode other than <b>Custom</b> , the BIOS automatically sets the rest of the options. You can only change the rest of the options if the mode is set to <b>Custom</b> . This option is set to <b>Performance Per Watt (OS)</b> by default. Other options include <b>Performance</b> and <b>Custom</b> . <b>i</b> <b>NOTE:</b> All the parameters on the system profile setting screen are available only when the <b>System Profile</b> option is set to <b>Custom</b> .
<b>CPU Power Management</b>	Sets the CPU power management. This option is set to <b>OS DBPM</b> by default. Other option includes <b>Maximum Performance</b> .
<b>Memory Frequency</b>	Sets the speed of the system memory. You can select <b>Maximum Performance</b> or a specific speed. This option is set to <b>Maximum Performance</b> by default.
<b>Turbo Boost</b>	Enables or disables the processor to operate in the turbo boost mode. This option is set to <b>Enabled</b> by default.
<b>C-States</b>	Enables or disables the processor to operate in all available power states. C States allow the processor to enter lower power states when idle. When set to <b>Enabled</b> (OS controlled) or when set to <b>Autonomous</b> (if hardware controlled is supported), the processor can operate in all available Power States to save power, but may increase memory latency and frequency jitter. This option is set to <b>Enabled</b> by default.
<b>Write Data CRC</b>	When set to <b>Enabled</b> , DDR4 data bus issues are detected and corrected during 'write' operations. Two extra cycles are required for CRC bit generation which impacts the performance. Read-only unless System Profile is set to <b>Custom</b> . This option is set to <b>Disabled</b> by default.
<b>Memory Patrol Scrub</b>	Sets the memory patrol scrub mode. This option is set to <b>Standard</b> by default.
<b>Memory Refresh Rate</b>	Sets the memory refresh rate to either 1x or 2x. This option is set to <b>1x</b> by default.
<b>Workload Profile</b>	Allows optimization of performance based on the workload type. The <b>Workload Profile</b> setting is not a <b>state</b> . Setting a Workload Profile is a one-time action that in turns modifies various BIOS settings to be optimized for the requested workload type. This option is set to <b>Not Configured</b> by default.
<b>PCI ASPM L1 Link Power Management</b>	Enables or disables the PCI ASPM L1 Link Power Management. This option is set to <b>Enabled</b> by default.
<b>Determinism Slider</b>	Set the system determinism by <b>Power Determinism</b> or <b>Performance Determinism</b> . This option is set to <b>Performance Determinism</b> by default.



**Table 55. System Profile Settings details (continued)**

Option	Description
<b>Power Profile Select</b>	<b>High performance Mode(default):</b> Favors core performance. All DF P-States are available in this mode and the default DF P-State and DLWM algorithms are active. <b>Efficiency Mode:</b> Configures the system for power efficiency. Limits boost frequency available to cores and restricts DF P-States available in the system. <b>Maximum IO Performance Mode:</b> Sets up Date Fabric to maximize IO sub-system performance.
<b>PCIE Speed PMM Control</b>	Reduce link speed when devices are idle. This option is set to <b>Auto</b> by default.
<b>EQ Bypass To Highest Rate</b>	Controls the ability to advertise Equalization Bypass to Highest Rate Support in TSxs sent prior to LinkUp=1r. This option is set to <b>Disabled</b> by default.
<b>DF PState Frequency Optimizer</b>	<b>Disabled:</b> Disabled the DP P-state CCLK effective frequency optimizer. <b>Enabled:</b> Enables the DP P-state CCLK effective frequency optimizer. This option is set to <b>Enabled</b> by default.
<b>DF PState Latency Optimizer</b>	<b>Disabled:</b> Disables the DP P-state latency optimizer. <b>Enabled:</b> Enables the DF P-state latency optimizer. This option is set to <b>Enabled</b> by default.
<b>DF CState</b>	This field enables(0xF)/disables(0x0) DF Cstate. This option is set to <b>Enabled</b> by default.
<b>Host System Management Port(HSMP)Support</b>	This value controls Host System Management Port(HSMP) interface to provide OS-level software with access to system management functions via a set of mail box registers. This option is set to <b>Enabled</b> by default.
<b>Boost FMax</b>	Boost Fmax. This option is set to <b>0 - Auto</b> by default.
<b>Algorithm Performance Boost Disable (ApbDis)</b>	Enables or disables the Algorithm Performance Boost Disable (ApbDis). This option is set to <b>Disabled</b> by default.

## System Security

To view the **System Security** screen, power on the system, press F2, and click **System Setup Main Menu > System BIOS > System Security**.

**Table 56. System Security details**

Option	Description
<b>CPU AES-NI</b>	Improves the speed of applications by performing encryption and decryption by using the Advanced Encryption Standard Instruction Set (AES-NI). This option is set to <b>Enabled</b> by default.
<b>System Password</b>	Sets the system password. This option is set to <b>Enabled</b> by default and is read-only if the password jumper is not installed in the system.
<b>Setup Password</b>	Sets the setup password. This option is read-only if the password jumper is not installed in the system.
<b>Password Status</b>	Locks the system password. This option is set to <b>Unlocked</b> by default.

**Table 57. System Security details (continued)**

Option	Description
<b>TPM Security</b>	This field controls the reporting of the Trusted Platform Module(TPM) in the system. When set to Off, the presence of the TPM is not reported to the OS. When set to Off, the presence of the TPM is not reported to the OS. When set to On, the presence of the TPM is reported to the OS.
<b>TPM Information</b>	Indicates the type of Trusted Platform Module, if present.
<b>TPM Firmware</b>	Indicates the firmware version of a Trusted Platform Module(TPM).
<b>TPM Heirachy</b>	Allows enabling, disabling or clearing the storage and endorsement hierarchies.

**Table 57. System Security details (continued)**

Option	Description
	<p>When set to Enabled, the storage and endorsement hierarchies can be used. When set to Disabled, the storage and endorsement hierarchies cannot be used. When set to Clear, the storage and endorsement hierarchies are cleared of any values and then reset to Enabled.</p>
<p><b>TPM Advanced Settings</b></p>	<p><b>TPM PPI Bypass Provision</b> When set to Enabled, allows the Operating System to bypass Physical Presence Interface(PPI) prompts when issuing PPI Advanced Configuration and Power Interface (ACPI) provisioning operations.</p> <p><b>TPM PPI Bypass Clear</b> When set to Enabled, allows the Operating System to bypass Physical Presence Interface(PPI) prompts when issuing PPI Advanced Configuration and Power Interface (ACPI) clear operations.</p> <p><b>TPM2 Algorithm Selection</b> Allows the user to change the cryptographic algorithms used in the Trusted Platform Module (TPM). The available options are dependant on the TPM firmware.</p> <p>To enable TPM2 Algorithm Selection, Intel(R) TXT technology must be disabled.</p>
<p><b>AMD DRTM</b></p>	<p>Enable/Disable AMD Dynamic Root of Trust Measurement (DRTM)</p> <p>To enable AMD DRTM, below configurations must be enabled:</p> <ol style="list-style-type: none"> <li>1. TPM2.0 must be enabled and the hash algorithm must be set to SHA256.</li> <li>2. Transparent SME (TSME) must be enabled.</li> </ol>
<p><b>Power Button</b></p>	<p>Enables or disables the power button on the front of the system. This option is set to <b>Enabled</b> by default.</p>
<p><b>AC Power Recovery</b></p>	<p>Sets how the system behaves after AC power is restored to the system. This option is set to <b>Last</b> by default.</p>
<p><b>AC Power Recovery Delay</b></p>	<p>Sets the time delay for the system to power up after AC power is restored to the system. This option is set to <b>Immediate</b> by default.</p>
<p><b>User Defined Delay (120s to 600s)</b></p>	<p>Controls the duration for which the power-on process is delayed after the AC power supply is restored. The value is only effective if AC Power Recovery Delay is set to <b>User Defined</b>. The valid range is between <b>120s and 600s</b>.</p>
<p><b>UEFI Variable Access</b></p>	<p>Provides varying degrees of securing UEFI variables. When set to <b>Standard</b> (the default), UEFI variables are accessible in the operating system per the UEFI specification. When set to <b>Controlled</b>, selected UEFI variables are protected in the environment and new UEFI boot entries are forced to be at the end of the current boot order.</p>
<p><b>SMM Security Mitigation</b></p>	<p>This option <b>enables</b> or <b>disables</b> additional UEFI SMM Security Mitigation protections. This option is available only in <b>UEFI boot mode</b>. The operating system can use this feature to help protect the <b>secure environment</b> created by <b>virtualization based security</b>. Enabling this feature provides additional UEFI SMM Security Mitigation protections. However, this feature may cause <b>compatibility</b> issue or loss of functionality with some legacy tools or applications.</p>
<p><b>Secure Boot</b></p>	<p>Enables Secure Boot, where the BIOS authenticates each pre-boot image by using the certificates in the Secure Boot Policy. Secure Boot is set to <b>Disabled</b> by default.</p>
<p><b>Secure Boot Policy</b></p>	<p>When Secure Boot policy is set to <b>Standard</b>, the BIOS uses the system manufacturer's key and certificates to authenticate pre-boot images. When Secure Boot policy is set to <b>Custom</b>, the BIOS uses the user-defined key and certificates. Secure Boot policy is set to <b>Standard</b> by default.</p>
<p><b>Secure Boot Mode</b></p>	<p>Configures how the BIOS uses the Secure Boot Policy Objects (PK, KEK, db, dbx). If the current mode is set to <b>Deployed Mode</b>, the available options are <b>User Mode</b> and <b>Deployed Mode</b>.</p>

**Table 57. System Security details (continued)**

Option	Description								
	<p><b>If the current mode is set to User Mode, the available options are User Mode, Audit Mode, and Deployed Mode.</b></p> <table border="1" data-bbox="798 302 1492 1019"> <caption><b>Table 58. Secure Boot Mode</b></caption> <thead> <tr> <th>Options</th> <th>Descriptions</th> </tr> </thead> <tbody> <tr> <td><b>User Mode</b></td> <td>In <b>User Mode</b>, PK must be installed, and BIOS performs signature verification on programmatic attempts to update policy objects. The BIOS allows unauthenticated programmatic transitions between modes.</td> </tr> <tr> <td><b>Deployed Mode</b></td> <td><b>Deployed Mode</b> is the most secure mode. In <b>Deployed Mode</b>, PK must be installed and the BIOS performs signature verification on programmatic attempts to update policy objects. <b>Deployed Mode</b> restricts the programmatic mode transitions.</td> </tr> <tr> <td><b>Audit Mode</b></td> <td>In <b>Audit mode</b>, PK is not present. The BIOS does not authenticate programmatic updates to the policy objects, and transitions between modes. The BIOS performs a signature verification on pre-boot images and logs the results in the image Execution Information Table, but executes the images whether they pass or fail verification. <b>Audit Mode</b> is useful for programmatic determination of a working set of policy objects.</td> </tr> </tbody> </table>	Options	Descriptions	<b>User Mode</b>	In <b>User Mode</b> , PK must be installed, and BIOS performs signature verification on programmatic attempts to update policy objects. The BIOS allows unauthenticated programmatic transitions between modes.	<b>Deployed Mode</b>	<b>Deployed Mode</b> is the most secure mode. In <b>Deployed Mode</b> , PK must be installed and the BIOS performs signature verification on programmatic attempts to update policy objects. <b>Deployed Mode</b> restricts the programmatic mode transitions.	<b>Audit Mode</b>	In <b>Audit mode</b> , PK is not present. The BIOS does not authenticate programmatic updates to the policy objects, and transitions between modes. The BIOS performs a signature verification on pre-boot images and logs the results in the image Execution Information Table, but executes the images whether they pass or fail verification. <b>Audit Mode</b> is useful for programmatic determination of a working set of policy objects.
Options	Descriptions								
<b>User Mode</b>	In <b>User Mode</b> , PK must be installed, and BIOS performs signature verification on programmatic attempts to update policy objects. The BIOS allows unauthenticated programmatic transitions between modes.								
<b>Deployed Mode</b>	<b>Deployed Mode</b> is the most secure mode. In <b>Deployed Mode</b> , PK must be installed and the BIOS performs signature verification on programmatic attempts to update policy objects. <b>Deployed Mode</b> restricts the programmatic mode transitions.								
<b>Audit Mode</b>	In <b>Audit mode</b> , PK is not present. The BIOS does not authenticate programmatic updates to the policy objects, and transitions between modes. The BIOS performs a signature verification on pre-boot images and logs the results in the image Execution Information Table, but executes the images whether they pass or fail verification. <b>Audit Mode</b> is useful for programmatic determination of a working set of policy objects.								
<b>Secure Boot Policy Summary</b>	Specifies the list of certificates and hashes that secure boot uses to authenticate images.								
<b>Secure Boot Custom Policy Settings</b>	Configures the Secure Boot Custom Policy. To enable this option, set the Secure Boot Policy to <b>Custom</b> option.								

## Creating a system and setup password


### Prerequisites

Ensure that the password jumper is enabled. The password jumper enables or disables the system password and setup password features. For more information, see the System board jumper settings section.

**i** **NOTE:** If the password jumper setting is disabled, the existing system password and setup password are deleted and you need not provide the system password to boot the system.

### Steps

- To enter System Setup, press F2 immediately after turning on or rebooting your system.
- On the **System Setup Main Menu** screen, click **System BIOS > System Security**.
- On the **System Security** screen, verify that **Password Status** is set to **Unlocked**.
- In the **System Password** field, type your system password, and press Enter or Tab.  
Use the following guidelines to assign the system password:
  - A password can have up to 32 characters.
 A message prompts you to reenter the system password.
- Reenter the system password, and click **OK**.
- In the **Setup Password** field, type your setup password and press Enter or Tab.  
A message prompts you to reenter the setup password.
- Reenter the setup password, and click **OK**.
- Press Esc to return to the System BIOS screen. Press Esc again.  
A message prompts you to save the changes.

 **NOTE:** Password protection does not take effect until the system reboots.

## Using your system password to secure your system

### About this task


If you have assigned a setup password, the system accepts your setup password as an alternate system password.

### Steps

1. Turn on or reboot your system.
2. Type the system password and press Enter.


### Next steps

When **Password Status** is set to **Locked**, type the system password and press Enter when prompted at reboot.

 **NOTE:** If an incorrect system password is typed, the system displays a message and prompts you to reenter your password. You have three attempts to type the correct password. After the third unsuccessful attempt, the system displays an error message that the system has stopped functioning and must be turned off. Even after you turn off and restart the system, the error message is displayed until the correct password is entered.


## Deleting or changing system and setup password

### Prerequisites

 **NOTE:** You cannot delete or change an existing system or setup password if the **Password Status** is set to **Locked**.

### Steps

1. To enter System Setup, press F2 immediately after turning on or restarting your system.
2. On the **System Setup Main Menu** screen, click **System BIOS > System Security**.
3. On the **System Security** screen, ensure that **Password Status** is set to **Unlocked**.
4. In the **System Password** field, alter or delete the existing system password, and then press Enter or Tab.
5. In the **Setup Password** field, alter or delete the existing setup password, and then press Enter or Tab.  
If you change the system and setup password, a message prompts you to reenter the new password. If you delete the system and setup password, a message prompts you to confirm the deletion.
6. Press Esc to return to the **System BIOS** screen. Press Esc again, and a message prompts you to save the changes.
7. Select **Setup Password**, change, or delete the existing setup password and press Enter or Tab.

 **NOTE:** If you change the system password or setup password, a message prompts you to reenter the new password. If you delete the system password or setup password, a message prompts you to confirm the deletion.

## Operating with setup password enabled

If **Setup Password** is set to **Enabled**, type the correct setup password before modifying the system setup options.

If you do not type the correct password in three attempts, the system displays the following message:

```
Invalid Password! Number of unsuccessful password attempts: <x> System Halted! Must power down.
```

```
Password Invalid. Number of unsuccessful password attempts: <x> Maximum number of password attempts exceeded. System halted.
```

Even after you turn off and restart the system, the error message is displayed until the correct password is typed. The following options are exceptions:

- If **System Password** is not set to **Enabled** and is not locked through the **Password Status** option, you can assign a system password. For more information, see the System Security Settings screen section.
- You cannot disable or change an existing system password.

**i** **NOTE:** You can use the password status option with the setup password option to protect the system password from unauthorized changes.

## Redundant OS Control

To view the **Redundant OS Control** screen, power on the system, press F2, and click **System Setup Main Menu > System BIOS > Redundant OS Control**.

**Table 59. Redundant OS Control details**

Option	Description
<b>Redundant OS Location</b>	Enables you to select a backup disk from the following device: <ul style="list-style-type: none"> <li>• <b>None</b></li> <li>• <b>BOSS PCIe Cards (Internal M.2 Drives)</b></li> </ul>
<b>Redundant OS State</b>	<p><b>i</b> <b>NOTE:</b> This option is disabled if <b>Redundant OS Location</b> is set to <b>None</b>.</p> <p>When set to <b>Visible</b>, the backup disk is visible to the boot list and OS. When set to <b>Hidden</b>, the backup disk is disabled and is not visible to the boot list and OS. This option is set to <b>Visible</b> by default.</p> <p><b>i</b> <b>NOTE:</b> BIOS disables the device in hardware, so it is not accessed by the OS.</p>
<b>Redundant OS Boot</b>	<p><b>i</b> <b>NOTE:</b> This option is disabled if <b>Redundant OS Location</b> is set to <b>None</b> or if <b>Redundant OS State</b> is set to <b>Hidden</b>.</p> <p>When set to <b>Enabled</b>, BIOS boots to the device specified in <b>Redundant OS Location</b>. When set to <b>Disabled</b>, BIOS preserves the current boot list settings. This option is set to <b>Enabled</b> by default.</p>

## Miscellaneous Settings

To view the **Miscellaneous Settings** screen, power on the system, press F2, and click **System Setup Main Menu > System BIOS > Miscellaneous Settings**.

**Table 60. Miscellaneous Settings details**

Option	Description
<b>System Time</b>	Enables you to set the time on the system.
<b>System Date</b>	Enables you to set the date on the system.
<b>Time Zone</b>	Times offset from UTC.
<b>Daylight Savings Time</b>	Enables or disables the Daylight Savings Time option. This option is set to <b>Disabled</b> by default.
<b>Asset Tag</b>	Specifies the asset tag and enables you to modify it for security and tracking purposes.
<b>Keyboard NumLock</b>	Enables you to set whether the system boots with the NumLock enabled or disabled. This option is set to <b>On</b> by default. <b>i</b> <b>NOTE:</b> This option does not apply to 84-key keyboards.
<b>F1/F2 Prompt on Error</b>	Enables or disables the F1/F2 prompt on error. This option is set to <b>Enabled</b> by default. The F1/F2 prompt also includes keyboard errors.
<b>Load Legacy Video Option ROM</b>	Enables or disables the Load Legacy Video Option ROM option. This option is set to <b>Disabled</b> by default.

**Table 60. Miscellaneous Settings details (continued)**

Option	Description
<b>Dell Wyse P25/P45 BIOS Access</b>	Enables or disables the Dell Wyse P25/P45 BIOS Access. This option is set to <b>Enabled</b> by default.
<b>Power Cycle Request</b>	Enables or disables the Power Cycle Request. This option is set to <b>None</b> by default.

## iDRAC Settings utility

The iDRAC settings utility is an interface to set up and configure the iDRAC parameters by using UEFI. You can enable or disable various iDRAC parameters by using the iDRAC settings utility.

 **NOTE:** Accessing some of the features on the iDRAC settings utility needs the iDRAC Enterprise License upgrade.

For more information about using iDRAC, see *Dell Integrated Dell Remote Access Controller User's Guide* at <https://www.dell.com/idracmanuals>.

## Device Settings


**Device Settings** enables you to configure device parameters such as storage controllers or network cards.

## Dell Lifecycle Controller

Dell Lifecycle Controller (LC) provides advanced embedded systems management capabilities including system deployment, configuration, update, maintenance, and diagnosis. LC is delivered as part of the iDRAC out-of-band solution and Dell system embedded Unified Extensible Firmware Interface (UEFI) applications.

## Embedded system management

The Dell Lifecycle Controller provides advanced embedded system management throughout the lifecycle of the system. The Dell Lifecycle Controller is started during the boot sequence and functions independently of the operating system.

 **NOTE:** Certain platform configurations may not support the full set of features provided by the Dell Lifecycle Controller.

For more information about setting up the Dell Lifecycle Controller, configuring hardware and firmware, and deploying the operating system, see the Dell Lifecycle Controller documentation at <https://www.dell.com/idracmanuals>.

## Boot Manager

The **Boot Manager** option enables you to select boot options and diagnostic utilities.

To enter **Boot Manager**, power on the system and press F11.

**Table 61. Boot Manager details**

Option	Description
<b>Continue Normal Boot</b>	The system attempts to boot to devices starting with the first item in the boot order. If the boot attempt fails, the system continues with the next item in the boot order until the boot is successful or no more boot options are found.
<b>One-shot UEFI Boot Menu</b>	Enables you to access boot menu, where you can select a one-time boot device to boot from.
<b>Launch System Setup</b>	Enables you to access System Setup.
<b>Launch Lifecycle Controller</b>	Exits the Boot Manager and invokes the Dell Lifecycle Controller program.

**Table 61. Boot Manager details (continued)**

Option	Description
<b>System Utilities</b>	Enables you to launch System Utilities menu such as Launch Diagnostics, BIOS update File Explorer, Reboot System.

## PXE boot

You can use the Preboot Execution Environment (PXE) option to boot and configure the networked systems remotely.

To access the **PXE boot** option, boot the system and then press F12 during POST instead of using standard Boot Sequence from BIOS Setup. It does not pull any menu or allows managing of network devices.

# Minimum to POST and system management configuration validation

This section describes the minimum to POST system requirement and system management configuration validation of the Dell system.

## Topics:

- [Minimum configuration to POST](#)
- [Configuration validation](#)

## Minimum configuration to POST

The components listed below are the minimum configuration to POST:

- One processor in processor socket 1
- One memory modules (DIMM) in slot A1
- One power supply unit
- System board + LOM + RIO card

## Configuration validation

The new generation of Dell systems have added interconnect flexibility and advanced iDRAC management features to collect precise system configuration information and report configuration errors.

When the system is powered on, information about installed cables, risers, backplanes, power supplies, floating card (fPERC, BOSS), and processor is obtained from the CPLD and backplane memory maps are analyzed. This information forms a unique configuration, which is compared with one of the qualified configurations that are stored in a table maintained by iDRAC.

One or more sensors are assigned to each of the configuration elements. During POST, any configuration validation error is logged in the System Event Log (SEL)/LifeCycle (LC) log. The reported events are categorized in the configuration validation error table.

**Table 62. Configuration validation error**

Error	Description	Possible cause and recommendations	Example
Config Error	A configuration element within the closest match contains something that is unexpected and does not match any Dell qualified configuration.	Wrong configuration	Config Error: Backplane cable CTRS_SRC_SA1 and BP-DST_SA1
		The element reported in HWC8010 errors are assembled incorrectly. Verify element (cable, risers, etc) placement in the system.	Config Error : SL Cable PLANAR_SL7 and CTRL_DST_PA1
Config Missing	iDRAC found a configuration element missing within the closest match detected.	Missing or damaged cable, device, or part	Config Missing: Float card front PERC/HBAadapter PERC/HBA
		Missing element or cable is reported in HWC8010 error logs. Install the missing element (cable, risers, etc).	Config Missing : SL cable PLANAR_SL8 and CTRL_DST_PA1



**Table 62. Configuration validation error (continued)**

Error	Description	Possible cause and recommendations	Example
Comm Error	A configuration element is not responding to iDRAC using the management interface while running an inventory check.	System management sideband communication Unplug AC Power, reseal the element and replace the element if the problem persists.	Comm Error: Backplane 2

## Error messages

This section describes the error messages displayed on the screen during POST or captured in the system event log (SEL)/ LifeCycle (LC) log.

**Table 63. Error message HWC8010**

Error code	HWC8010
Message	The System Configuration Check operation resulted in the following issue involving the indicated component type
Arguments	Riser, floating card (fPERClike BOSS), backplane, processor, cable, or other components
Detailed Description	The issue identified in the message is observed in the System Configuration Check operation.
Recommended Response Action	Do the following and retry the operation: <ol style="list-style-type: none"> <li>1. Disconnect the input power.</li> <li>2. Check for proper cable connection and component placement. If the issue persists, contact the service provider.</li> </ol>
Category	System Health (HWC = Hardware Config)
Severity	Critical
Trap/EventID	2329

**Table 64. Error message HWC8011**


Error code	HWC8011
Message	The System Configuration Check operation resulted in multiple issues involving the indicated component type
Arguments	Riser, floating card (fPERClike BOSS), backplane, processor, cable, or other components
Detailed Description	Multiple issues are observed in the System Configuration Check operation.
Recommended Response Action	Do the following and retry the operation: <ol style="list-style-type: none"> <li>1. Disconnect the input power.</li> <li>2. Check for proper cable connection and component placement. If the issue persists, contact the service provider.</li> </ol>
Category	System Health (HWC = Hardware Config)
Severity	Critical


# Installing and removing system components


## Topics:


- Safety instructions
- Before working inside your system
- After working inside your system
- Recommended tools
- Optional front bezel
- System cover
- Drive backplane cover
- Air shroud
- Cooling fan
- Drives
- Rear drive module
- Drive backplane
- Side wall brackets
- Cable routing
- PERC module
- Rear drive cage
- System memory
- Processor and heat sink
- Expansion cards and expansion card risers
- Optional serial COM port
- Optional VGA port for Direct Liquid Cooling module
- Optional BOSS-N1 module
- System battery
- Optional internal USB card
- Intrusion switch module
- Optional OCP card
- Power supply unit
- Trusted Platform Module
- System board
- LOM card and rear I/O board
- Control panel

## Safety instructions

 **NOTE:** To avoid injury, do not lift the system on your own. Get others to assist you.

 **WARNING:** Opening or removing the system cover while the system is turned on may expose you to a risk of electric shock..

 **CAUTION:** Many repairs may only be done by a certified service technician. You should only perform troubleshooting and simple repairs as authorized in your product documentation, or as directed by the online or telephone service and support team. Damage due to servicing that is not authorized by Dell is not covered by your warranty. Read and follow the safety instructions that are shipped with your product.

 **CAUTION:** To ensure proper operation and cooling, all system bays and fans must be always populated with a component or a blank.

- NOTE:** It is recommended that you always use an antistatic mat and antistatic strap while working on components inside the system.
- NOTE:** While replacing the hot swappable PSU, after next server boot; the new PSU automatically updates to the same firmware and configuration of the replaced one. For more information about the Part replacement configuration, see the *Lifecycle Controller User's Guide* at <https://www.dell.com/idracmanuals>
- NOTE:** While replacing faulty storage controller/FC/NIC card with the same type of card, after you power on the system; the new card automatically updates to the same firmware and configuration of the faulty one. For more information about the Part replacement configuration, see the *Lifecycle Controller User's Guide* at <https://www.dell.com/idracmanuals>
- NOTE:** For detailed information on cabling the cards, see the system-specific owner's manual at Installation and Service Manual available at <https://www.dell.com/poweredgemanuals>

## Before working inside your system

### Prerequisites

Follow the safety guidelines listed in [Safety instructions](#).

### Steps

1. Power off the system and all attached peripherals.
2. Disconnect the system from the electrical outlet, and disconnect the peripherals.
3. If applicable, remove the system from the rack.  
For more information, see the *Rail Installation Guide* relevant to your rail solutions at [www.dell.com/poweredgemanuals](http://www.dell.com/poweredgemanuals).
4. Remove the system cover.

## After working inside your system

### Prerequisites

Follow the safety guidelines listed in [Safety instructions](#).

### Steps

1. Replace the system cover.
2. If applicable, install the system into the rack.  
For more information, see the *Rail Installation Guide* relevant to your rail solutions at [www.dell.com/poweredgemanuals](http://www.dell.com/poweredgemanuals).
3. Reconnect the peripherals and connect the system to the electrical outlet, and then power on the system.

## Recommended tools

You may need some or all of the following tools to perform the removal and installation procedures:

- Key to the bezel lock. The key is required only if your system includes a bezel.
- Phillips 1 screwdriver
- Phillips 2 screwdriver
- Torx T8 screwdriver
- Torx T6 screwdriver
- Torx T20 screwdriver
- 5 mm hex nut screwdriver
- Plastic scribe
- 1/4-inch flat blade screwdriver
- Wrist grounding strap connected to the ground
- ESD mat

- Needle-nose pliers

You need the following tools to assemble the cables for a DC power supply unit:

- AMP 90871-1 hand-crimping tool or equivalent
- Tyco Electronics 58433-3 or equivalent
- Wire-stripper pliers to remove insulation from size 10 AWG solid or stranded, insulated copper wire

**i** **NOTE:** Use alpha wire part number 3080 or equivalent (65/30 stranding).

**i** **NOTE:** For information about DC PSU cabling instructions, go to <https://www.dell.com/poweredgemanuals> > **Rack Servers** > PowerEdge R7615 > **Select This Product** > **Documentation** > **Manuals and Documents** > *Cabling instructions for – 48 – 60 V DC power supply.*

## Optional front bezel

### Removing the front bezel

#### Prerequisites

1. Follow the safety guidelines listed in the [Safety instructions](#).

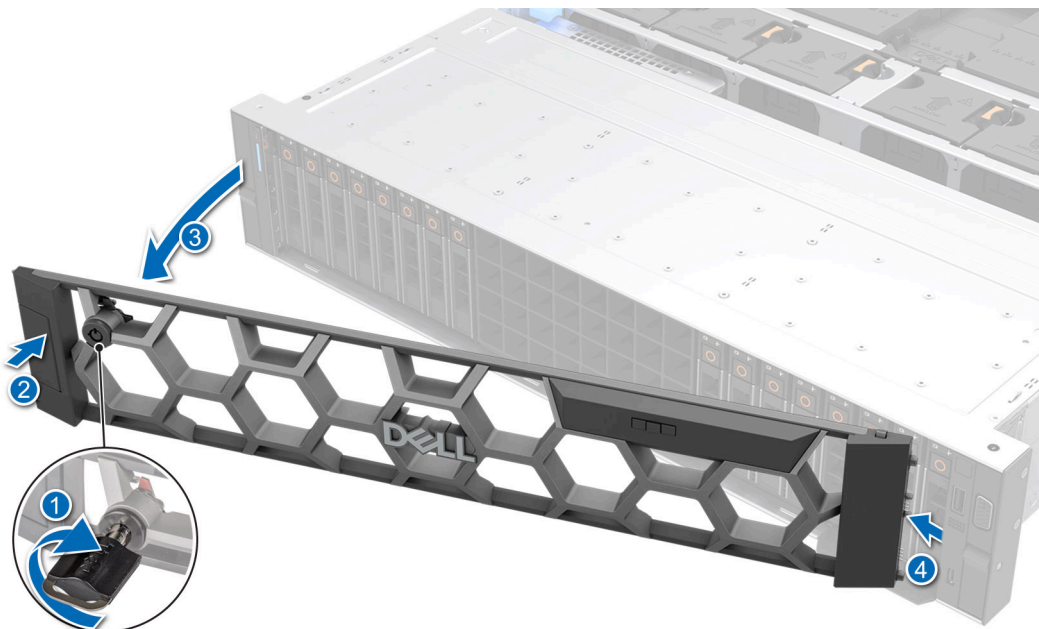
**i** **NOTE:** The bezel key is part of the bezel package.

#### Steps

1. **i** **NOTE:** The numbers on the image do not depict the exact steps. The numbers are for representation of sequence.

Unlock the bezel .

2. Press the release button, and remove the left end of the bezel.
3. Slide the tabs on the right end of the bezel out of the slots on the chassis and remove the bezel.



**Figure 23. Removing the front bezel**

# Installing the front bezel

## Prerequisites

1. Follow the safety guidelines listed in the [Safety instructions](#).

**NOTE:** The bezel key is part of the bezel package.

## Steps

1. Align and insert the tabs on the bezel into the slots on the chassis.
2. Press the bezel until the release button clicks in place.
3. Lock the bezel.

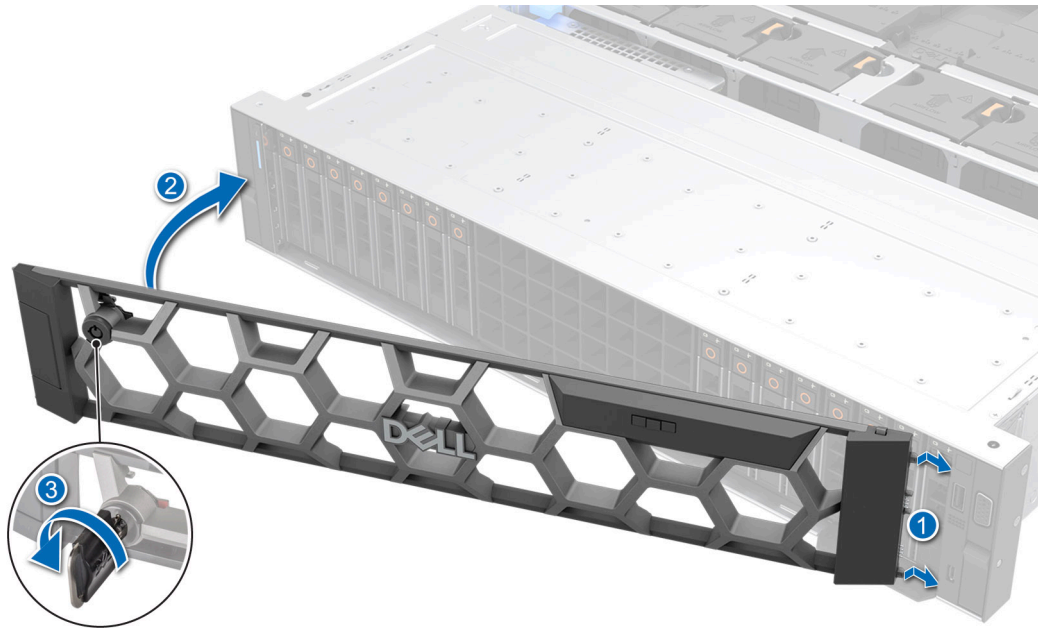


Figure 24. Installing the front bezel

# System cover

## Removing the system cover

### Prerequisites

1. Follow the safety guidelines listed in the [Safety instructions](#).
2. Follow the procedure listed in the [Before working inside your system](#).
3. Power off the system, including any attached peripherals.
4. Disconnect the system from the electrical outlet and peripherals.

### Steps

1. Use a 1/4 inch flat head or a Phillips #2 screwdriver to turn the lock counterclockwise to the unlock position.
2. Open the release latch until the system cover slides back.
3. Lift the cover from the system.



**Figure 25. Removing the system cover**

**Next steps**

1. [Replace the system cover.](#)

## Installing the system cover

**Prerequisites**

1. Follow the safety guidelines listed in the [Safety instructions](#).
2. Follow the procedure listed in the [Before working inside your system](#).
3. Ensure that all internal cables are connected and placed out of the way, and no tools or extra parts are left inside the system.

**Steps**

1. Align the tabs on the system cover with the guide slots on the chassis.
2. Close the system cover release latch.
3. Using a 1/4 inch flat head or Phillips #2 screwdriver, turn the lock clockwise to the lock position.



**Figure 26. Installing the system cover**

### Next steps

Follow the procedure listed in [After working inside your system](#).

## Drive backplane cover

### Removing the drive backplane cover

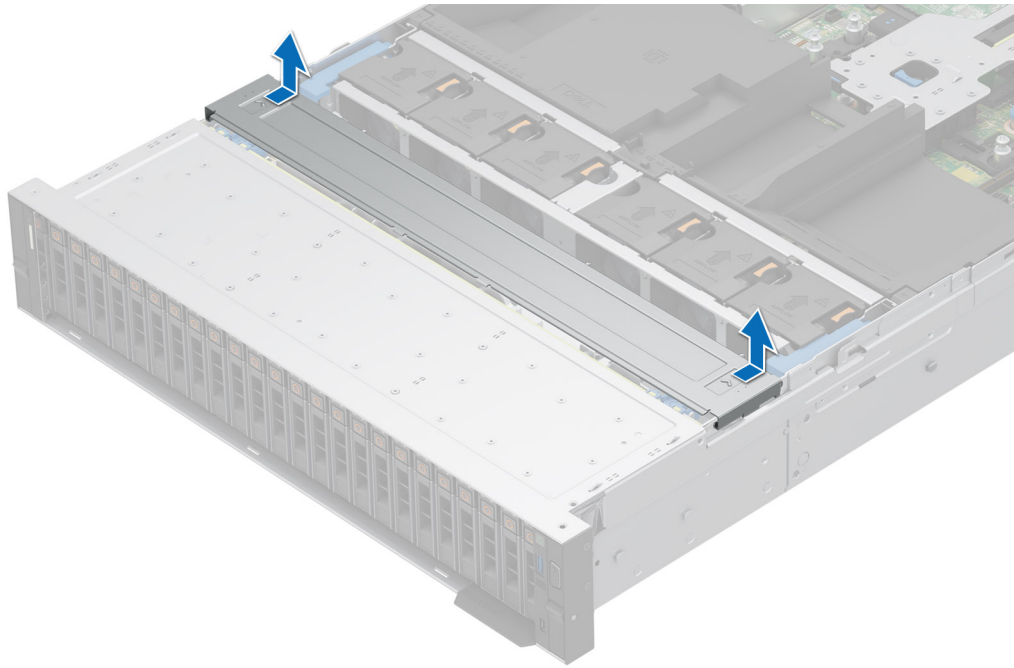
#### Prerequisites

1. Follow the safety guidelines listed in the [Safety instructions](#).
2. Follow the procedure listed in the [Before working inside your system](#).

**NOTE:** Route the cables properly to prevent the cables from being pinched or crimped.

#### Steps

1. Press and push the blue touch points to disengage the drive backplane cover.
2. Remove the cover from the chassis.



**Figure 27. Removing the drive backplane cover**

#### **Next steps**

1. [Install the drive backplane.](#)

## **Installing the drive backplane cover**

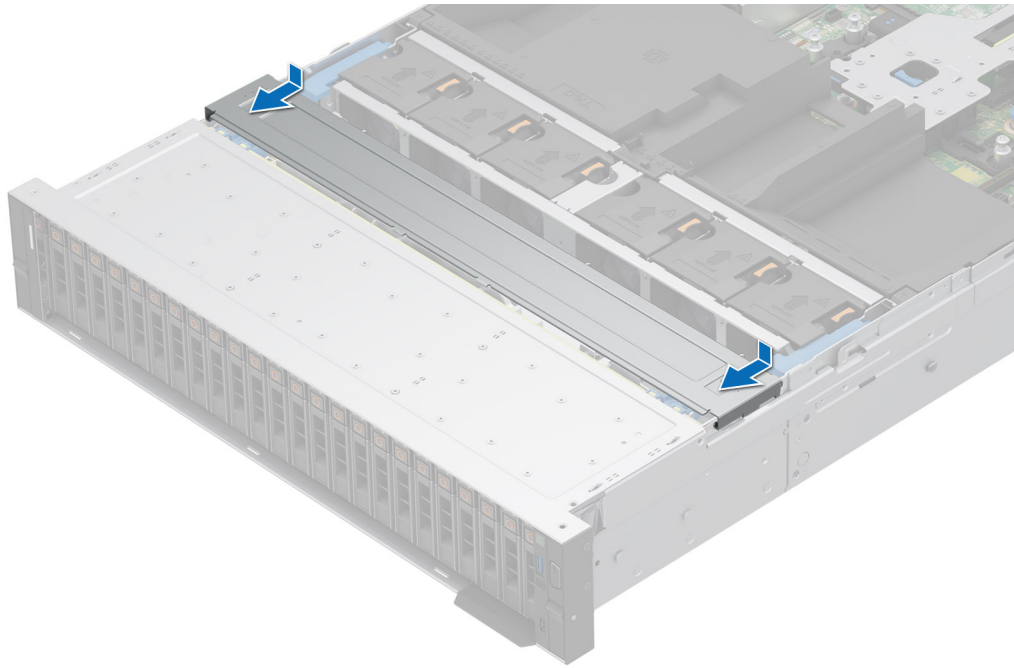
#### **Prerequisites**

1. Follow the safety guidelines listed in the [Safety instructions](#).
2. Follow the procedure listed in the [Before working inside your system](#).

#### **Steps**

1. Align the tabs on the drive backplane cover with the guide slots on the system.
2. Slide the cover until it is securely seated.





**Figure 28. Installing the drive backplane cover**

**Next steps**


1. Follow the procedure listed in [After working inside your system.](#)

# Air shroud

## Removing the air shroud

### Prerequisites

1. Follow the safety guidelines listed in the [Safety instructions](#).
2. Follow the procedure listed in the [Before working inside your system](#).

 **CAUTION:** Never operate your system with the air shroud removed. The system may get overheated quickly, resulting in shutdown of the system and loss of data.

### Steps

Hold the air shroud at both the ends, and lift it from the system.

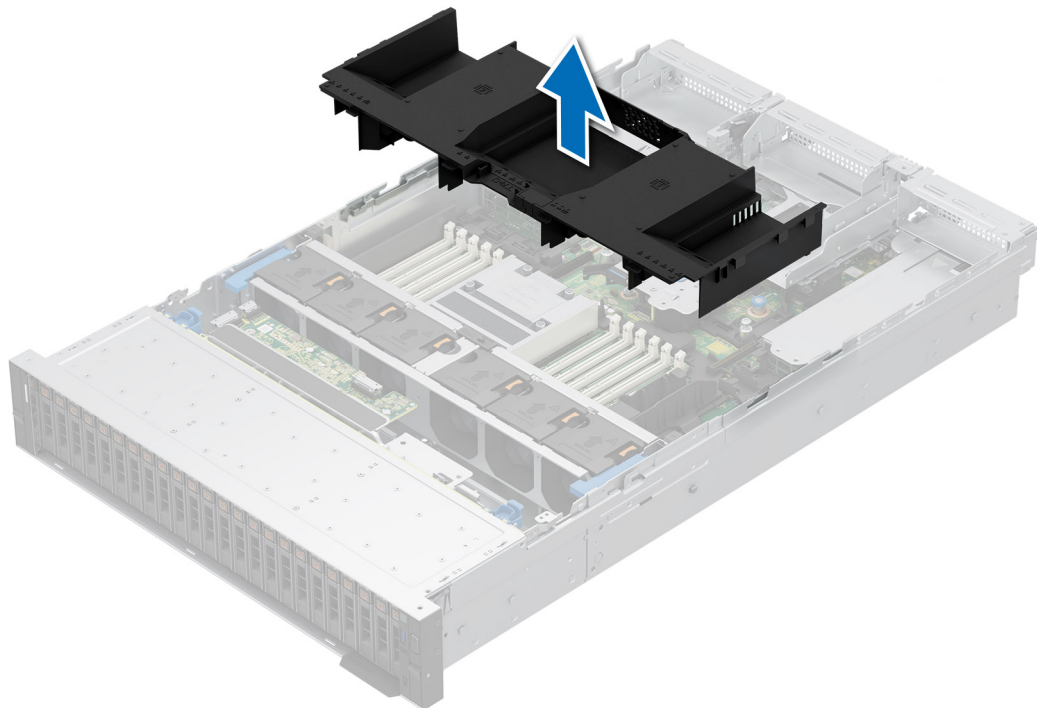


Figure 29. Removing the air shroud

### Next steps

1. [Replace the air shroud](#).


## Installing the air shroud

### Prerequisites

1. Follow the safety guidelines listed in the [Safety instructions](#).
2. Follow the procedure listed in the [Before working inside your system](#).

### Steps

1. Align the tabs on the air shroud with the slots on the chassis.

 **NOTE:** Route the cables properly to prevent the cables from being pinched or crimped.

2. Lower the air shroud into the system until it is firmly seated.

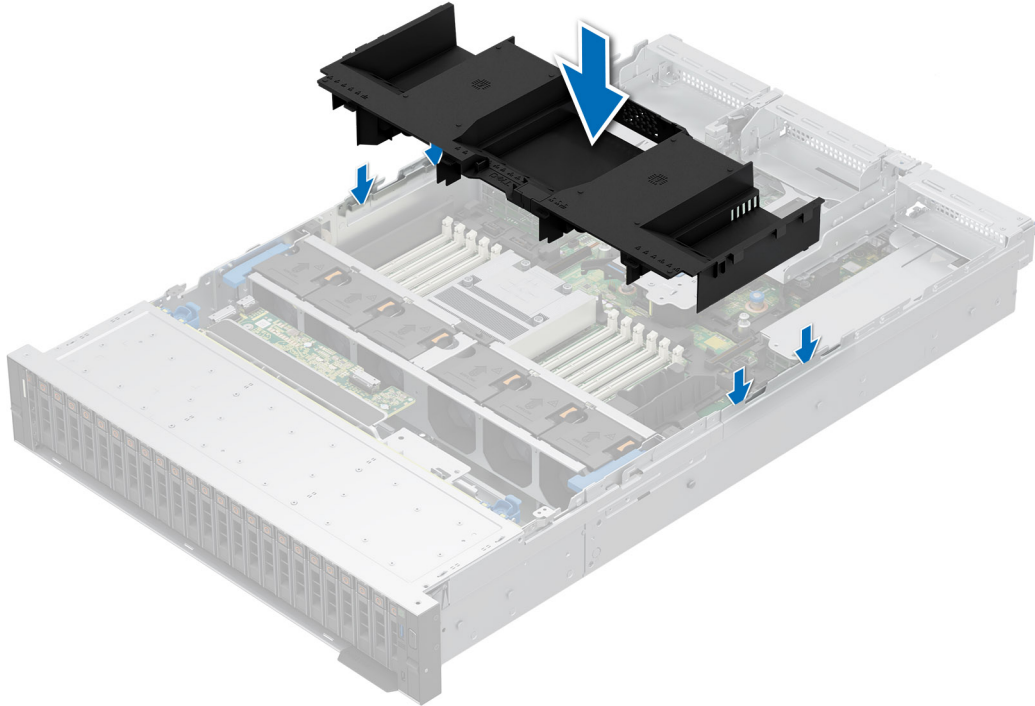


Figure 30. Installing the air shroud

#### Next steps

1. Follow the procedure listed in [After working inside your system](#).

## Removing the GPU air shroud top cover

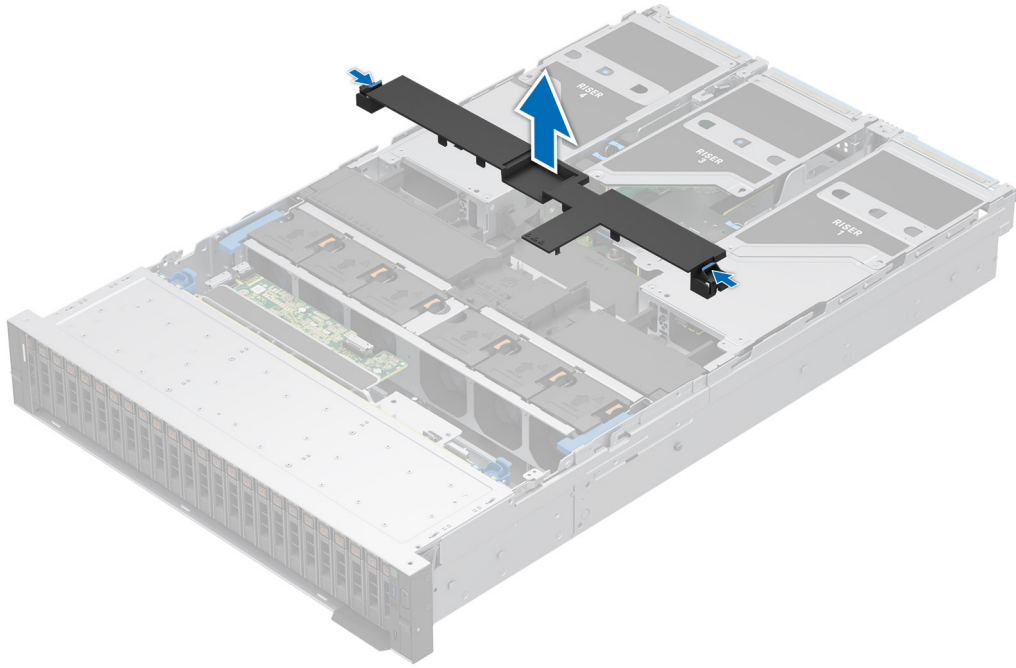
#### Prerequisites

**CAUTION:** Never operate your system with the air shroud removed. The system may get overheated quickly, resulting in shutdown of the system and loss of data.

1. Follow the safety guidelines listed in the [Safety instructions](#).
2. Follow the procedure listed in [Before working inside your system](#).

#### Steps

Press the tabs on either sides of the top cover, and lift the top cover out of the GPU air shroud.



**Figure 31. Removing the GPU air shroud top cover**

#### **Next steps**

1. [Replace the GPU air shroud top cover.](#)

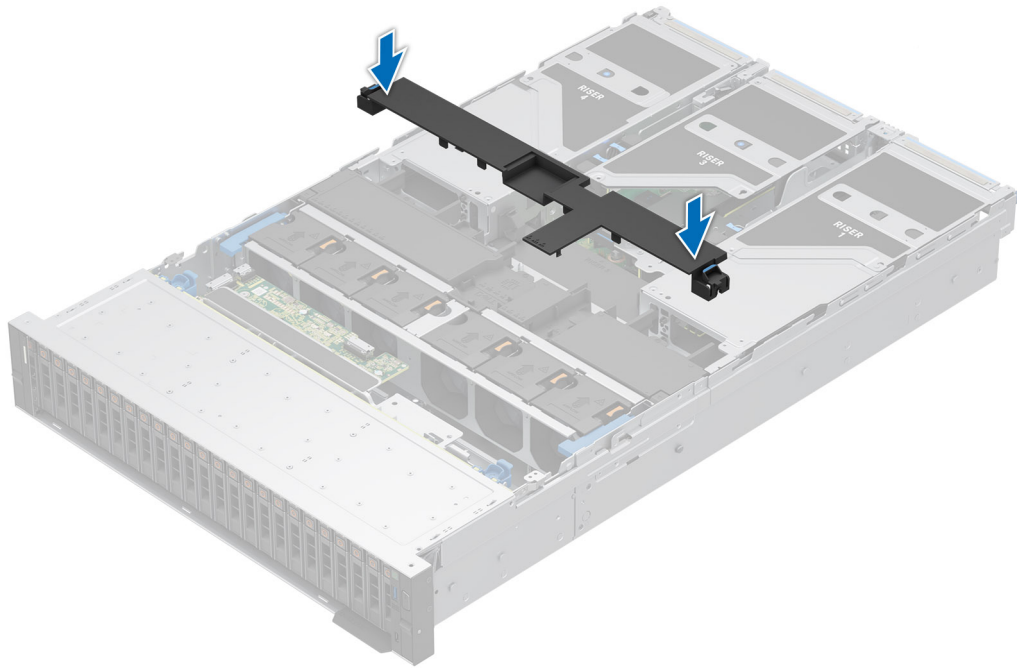
## **Installing the GPU air shroud top cover**

#### **Prerequisites**

1. Follow the safety guidelines listed in the [Safety instructions](#).
2. Follow the procedure listed in [Before working inside your system](#).

#### **Steps**

1. Align the tabs on the top cover with the slots on the GPU air shroud.
2. Press the top cover into the GPU air shroud until it is firmly seated.



**Figure 32. Installing the GPU air shroud top cover**

#### Next steps

1. Follow the procedure listed in [After working inside your system](#).

## Removing the GPU air shroud filler

#### Prerequisites

1. Follow the safety guidelines listed in the [Safety instructions](#).
2. Follow the procedure listed in [Before working inside your system](#).

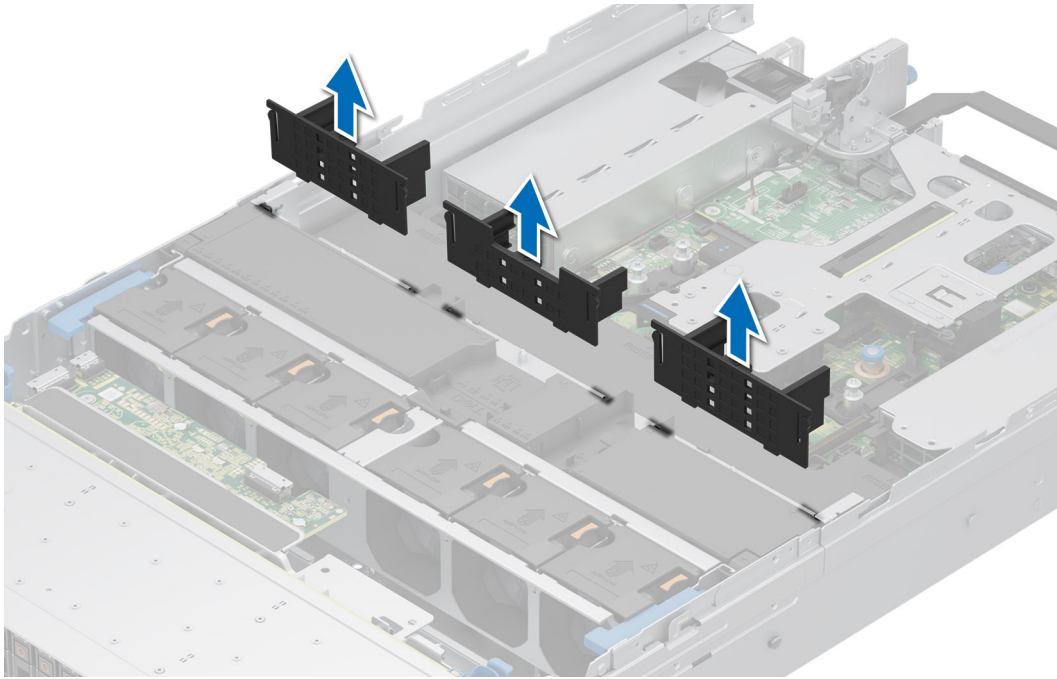
**CAUTION:** Never operate your system with the air shroud removed. The system may get overheated quickly, resulting in shutdown of the system and loss of data.

3. Remove the GPU air shroud top cover.

**NOTE:** The GPU air shroud filler must be removed to avoid interference with full length double-width GPU card installation.

#### Steps

Hold and lift the filler from the GPU air shroud.



**Figure 33. Removing the GPU air shroud filler**

#### **Next steps**

1. [Replace the GPU air shroud filler.](#)

## **Installing the GPU air shroud filler**

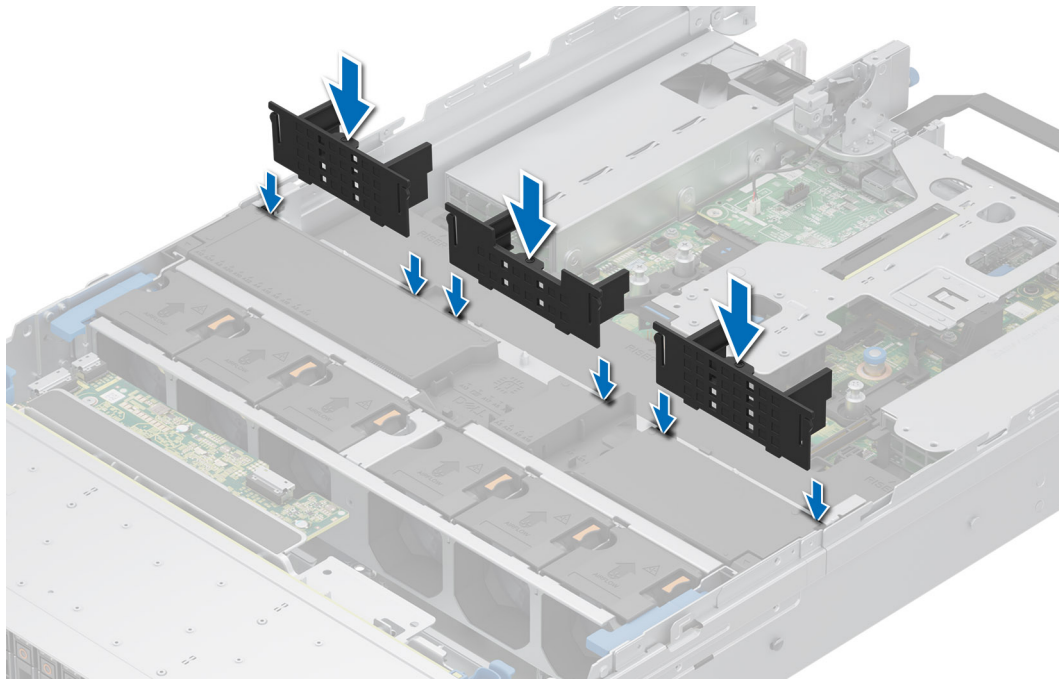
#### **Prerequisites**

1. Follow the safety guidelines listed in the [Safety instructions](#).
2. Follow the procedure listed in [Before working inside your system](#).
3. [Remove the GPU air shroud top cover](#).
4. If required, [remove the full length expansion card risers](#).

**i** **NOTE:** The GPU air shroud filler must be installed, if single-width GPU card or empty riser is used.

#### **Steps**

Align and install the filler into the slots on the GPU air shroud.



**Figure 34. Installing the GPU air shroud filler**

#### Next steps

1. [Install the GPU air shroud top cover.](#)
2. Follow the procedure listed in [After working inside your system.](#)

## Removing the GPU air shroud

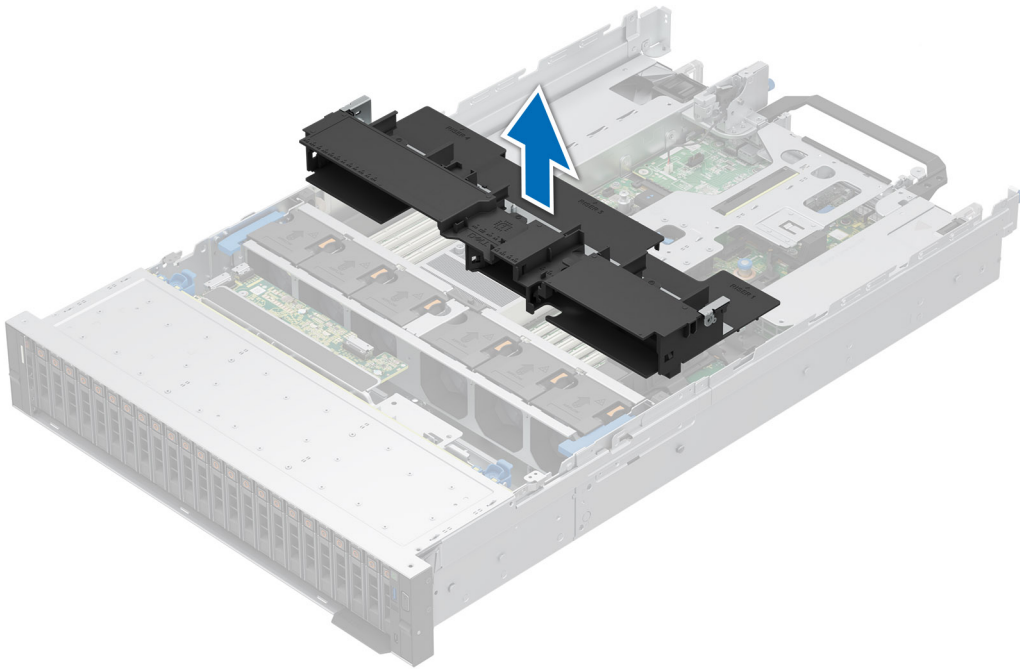
#### Prerequisites

**CAUTION:** Never operate your system with the air shroud removed. The system may get overheated quickly, resulting in shutdown of the system and loss of data.

1. Follow the safety guidelines listed in the [Safety instructions.](#)
2. Follow the procedure listed in [Before working inside your system.](#)
3. [Remove the GPU air shroud top cover.](#)
4. [Remove the full length expansion card risers.](#)

#### Steps

Hold the edges of the GPU air shroud, and lift the air shroud out of the system.



**Figure 35. Removing the GPU air shroud**

**Next steps**

1. [Replace the GPU air shroud.](#)

## Installing the GPU air shroud

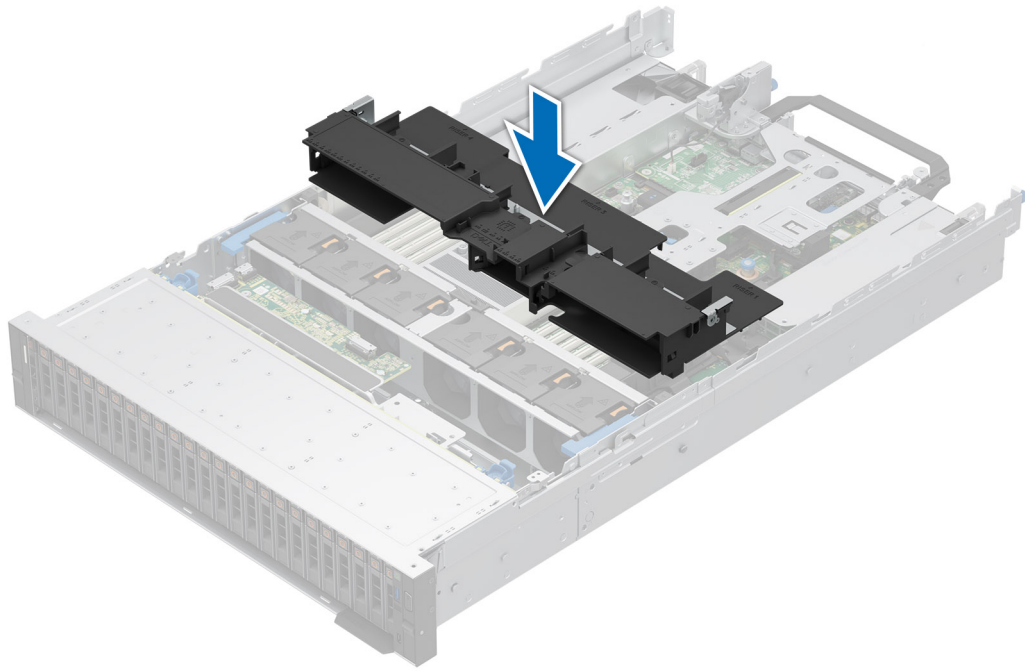
**Prerequisites**

1. Follow the safety guidelines listed in the [Safety instructions](#).
2. Follow the procedure listed in [Before working inside your system](#).
3. [Remove the GPU air shroud top cover.](#)
4. [Remove the full length expansion card risers.](#)

**Steps**

1. Align the tabs on the GPU air shroud with the slots on the system.
2. Lower the GPU air shroud into the system until it is firmly seated.





**Figure 36. Installing the GPU air shroud**

#### **Next steps**

1. [Install the full length expansion risers.](#)
2. [Install the GPU air shroud top cover.](#)
3. Follow the procedure listed in [After working inside your system.](#)

## **Removing the 2 x 2.5-inch rear drive module air shroud**

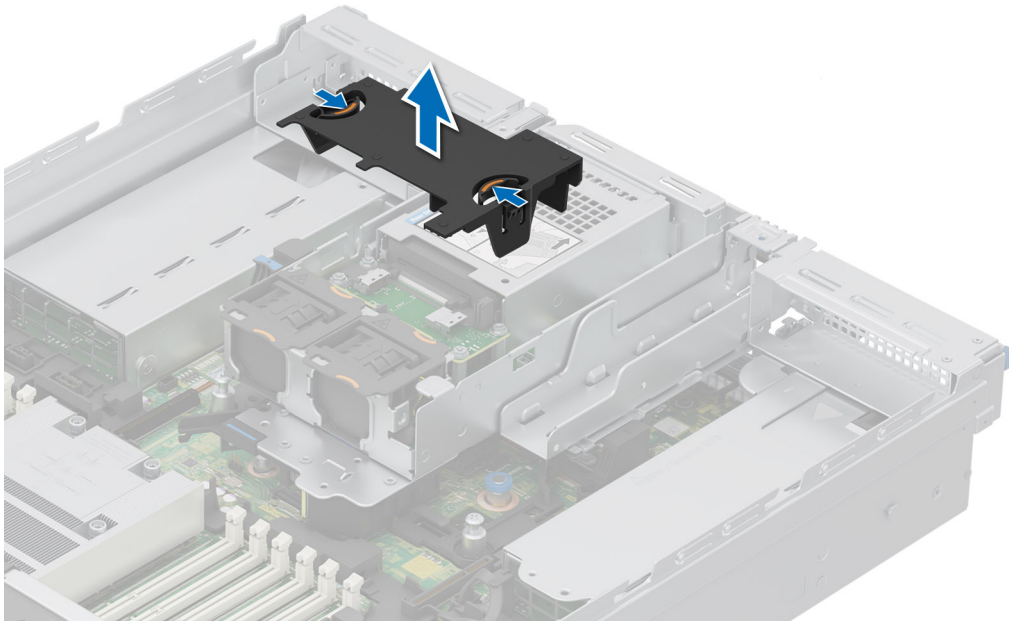
#### **Prerequisites**

**CAUTION:** Never operate your system with the air shroud removed. The system may get overheated quickly, resulting in shutdown of the system and loss of data.

1. Follow the safety guidelines listed in the [Safety instructions.](#)
2. Follow the procedure listed in [Before working inside your system.](#)

#### **Steps**

Press the edges and lift the air shroud out of the rear drive module.



**Figure 37. Removing the 2 x 2.5-inch rear drive module air shroud**

#### **Next steps**

1. [Replace the 2 x 2.5-inch rear drive module air shroud.](#)

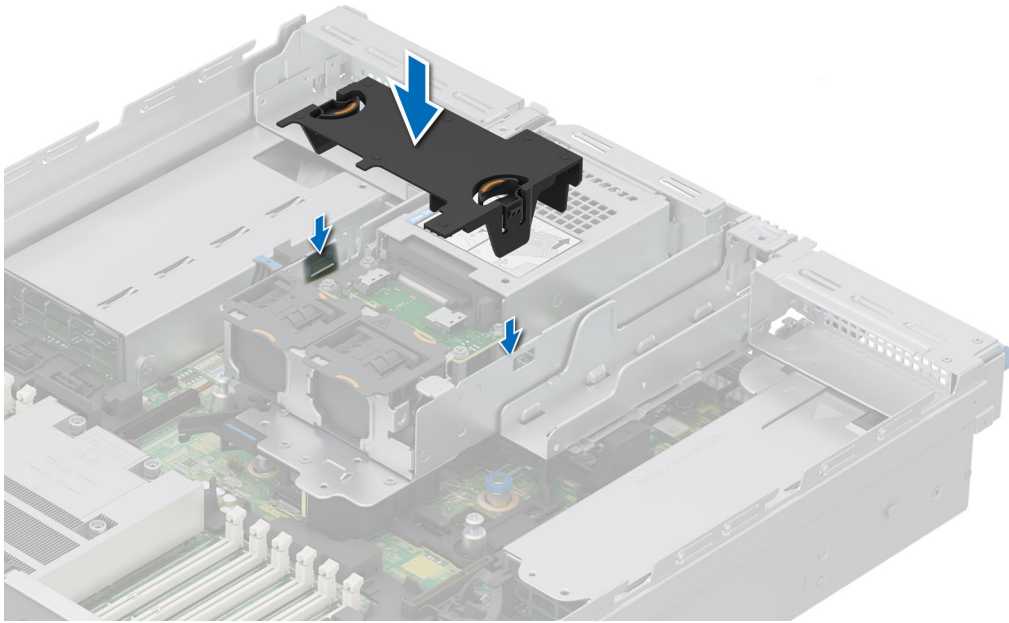
## **Installing the 2 x 2.5-inch rear drive module air shroud**

#### **Prerequisites**

1. Follow the safety guidelines listed in the [Safety instructions](#).
2. Follow the procedure listed in [Before working inside your system](#).

#### **Steps**

1. Align the tabs on the air shroud with the slots on the rear drive module.
2. Lower the air shroud into the rear drive module until it is firmly seated.



**Figure 38. Installing the 2 x 2.5-inch rear drive module air shroud**

#### Next steps

1. Follow the procedure listed in [After working inside your system](#).

## Removing the 4 x 2.5-inch rear drive module air shroud

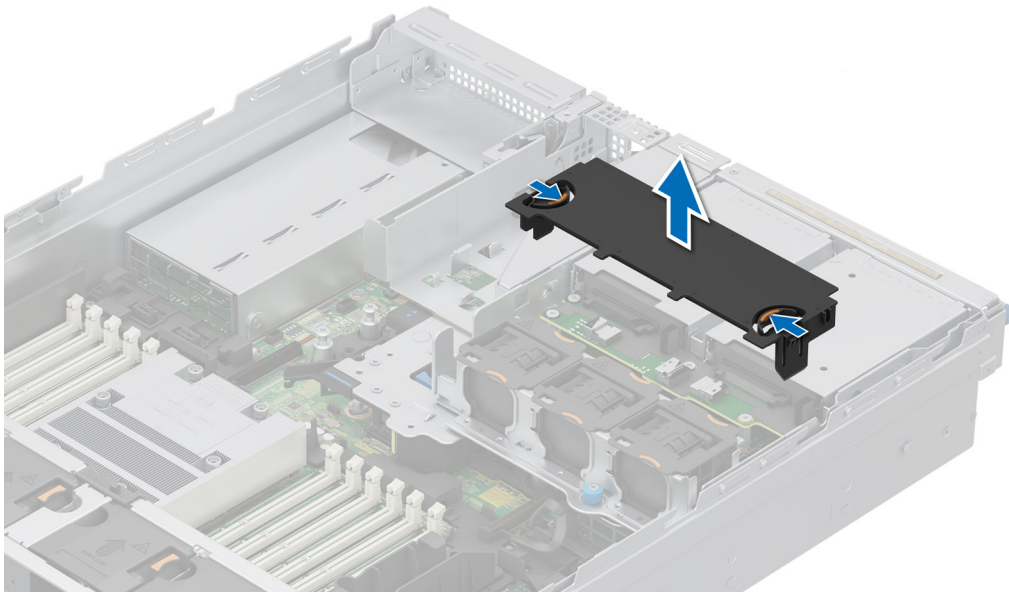
#### Prerequisites

**CAUTION:** Never operate your system with the air shroud removed. The system may get overheated quickly, resulting in shutdown of the system and loss of data.

1. Follow the safety guidelines listed in the [Safety instructions](#).
2. Follow the procedure listed in [Before working inside your system](#).

#### Steps

Press the edges and lift the air shroud out of the rear drive module.



**Figure 39. Removing the 4 x 2.5-inch rear drive module air shroud**

#### **Next steps**

1. [Replace the 4 x 2.5-inch rear drive module air shroud.](#)

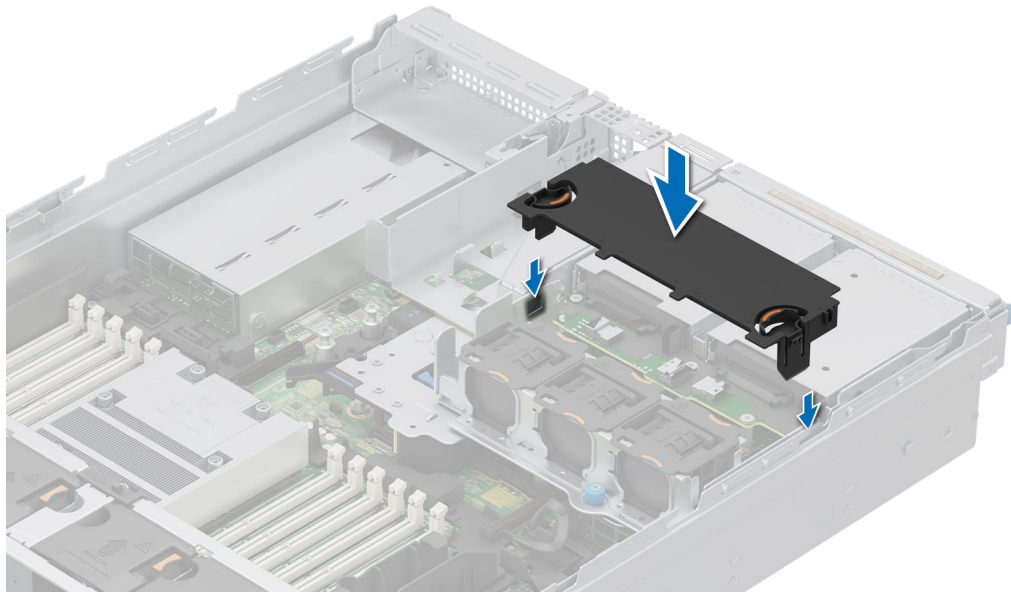
## **Installing the 4 x 2.5-inch rear drive module air shroud**

#### **Prerequisites**

1. Follow the safety guidelines listed in the [Safety instructions](#).
2. Follow the procedure listed in [Before working inside your system](#).

#### **Steps**

1. Align the tabs on the air shroud with the slots on the rear drive module.
2. Lower the air shroud into the rear drive module until it is firmly seated.



**Figure 40. Installing the 4 x 2.5-inch rear drive module air shroud**

#### **Next steps**

1. Follow the procedure listed in [After working inside your system](#).

## **Cooling fan**

### **Removing the cooling fan cage assembly**

#### **Prerequisites**

1. Follow the safety guidelines listed in the [Safety instructions](#).
2. Follow the procedure listed in the [Before working inside your system](#).
3. If required, [remove the air shroud](#) or [remove the GPU air shroud](#).

#### **Steps**

1. Lift the blue release levers to unlock the cooling fan cage assembly from the system.
2. Hold the release levers, and lift the cooling fan cage assembly away from the system.

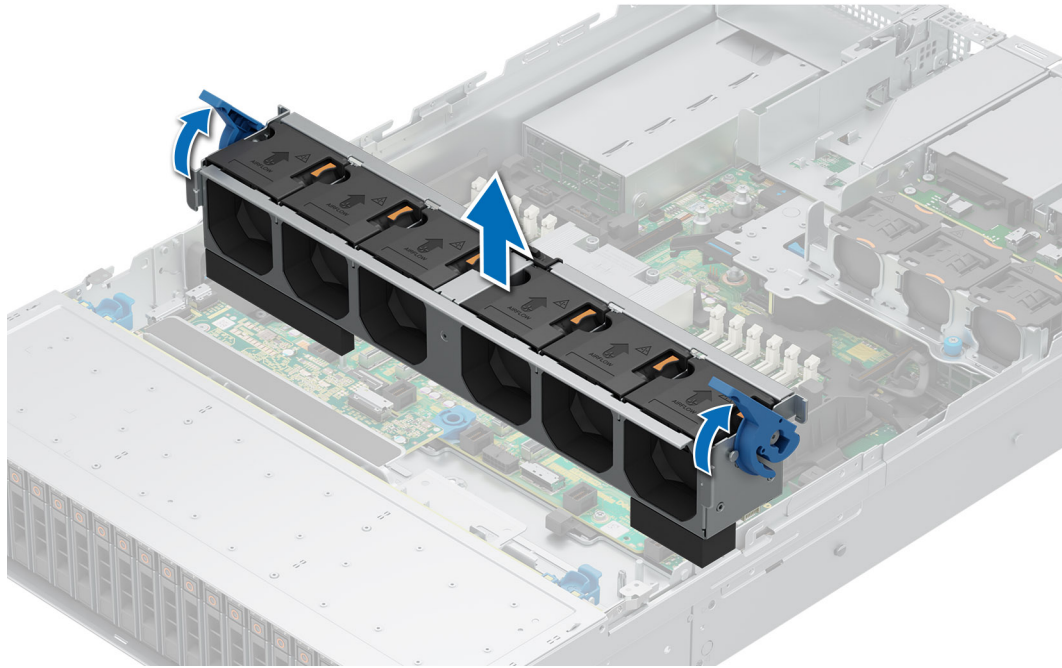


Figure 41. Removing the cooling fan cage assembly

#### Next steps

1. [Replace the cooling fan assembly.](#)

## Installing the cooling fan cage assembly

#### Prerequisites

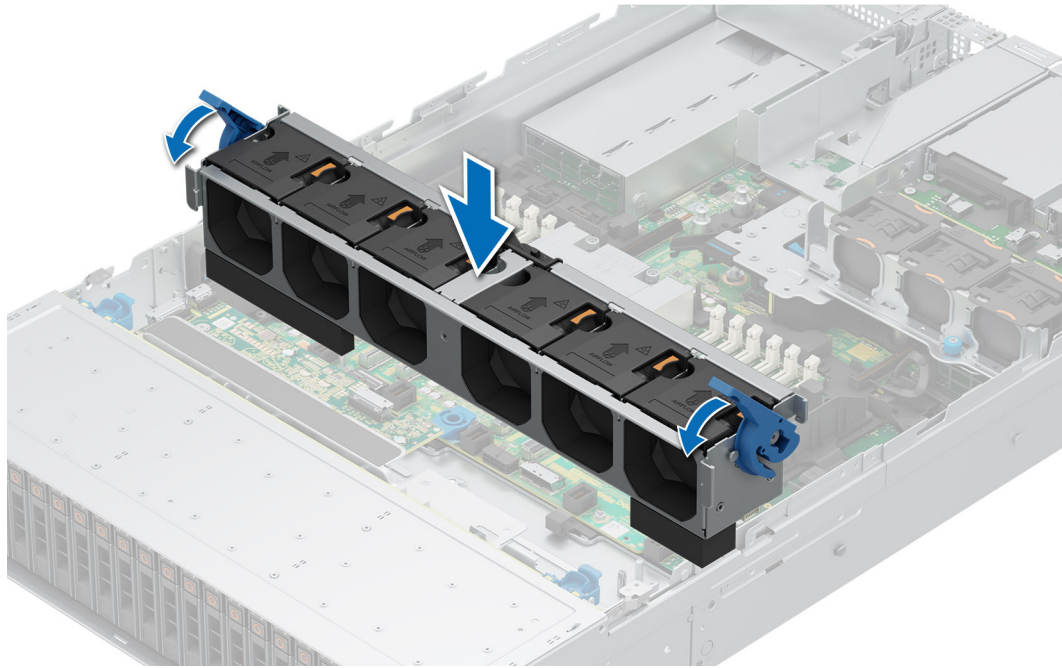
1. Follow the safety guidelines listed in the [Safety instructions](#).

**CAUTION:** Ensure that the cables inside the system are correctly installed and retained by the cable retention bracket before installing the cooling fan cage assembly. Incorrectly installed cables may get damaged.

2. Follow the procedure listed in [Before working inside your system](#).
3. If installed, [remove the air shroud](#) or [remove the GPU air shroud](#).

#### Steps

1. Holding the blue release lever of the cooling fan cage, align the guide rails with the guides on the system.
2. Lower the cooling fan cage assembly into the system until seated firmly.
3. Lower the blue release lever and press to lock the cooling fan cage assembly into the system.



**Figure 42. Installing the cooling fan cage assembly**

#### Next steps

1. If removed, [install the air shroud](#) .
2. Follow the procedure listed in [After working inside your system](#).

## Removing a cooling fan

#### Prerequisites

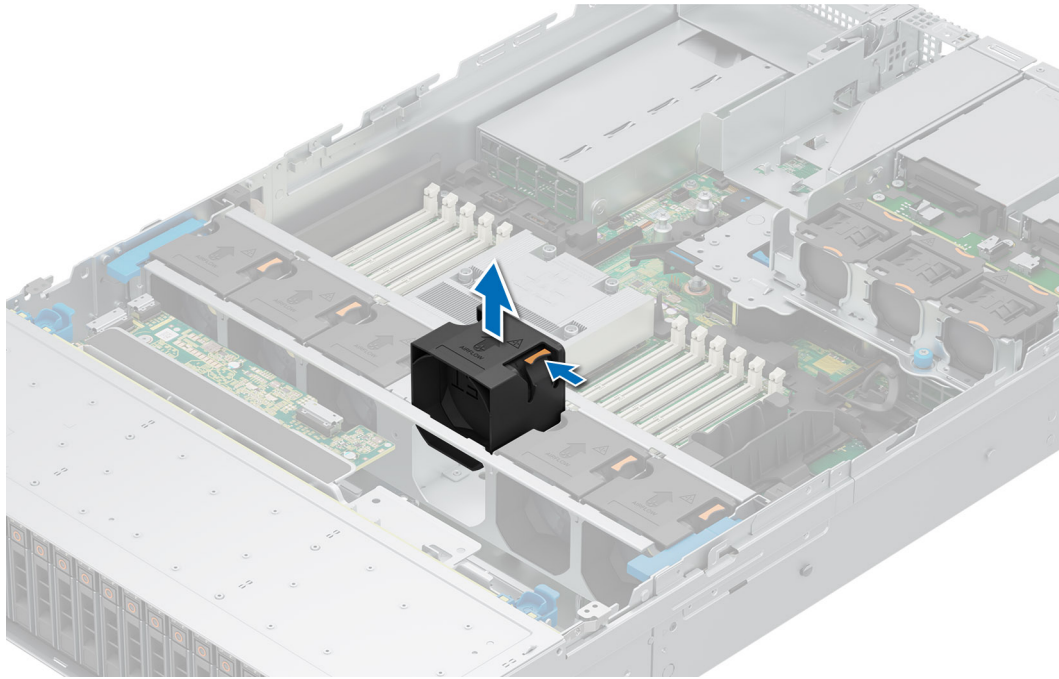
1. Follow the safety guidelines listed in the [Safety instructions](#).
2. Follow the procedure listed in [Before working inside your system](#).

**NOTE:** The procedure to remove standard (STD), high-performance silver grade (HPR SLVR), or high-performance gold grade (HPR GOLD) fan is same.

#### Steps

Press the orange release tab and lift the cooling fan to disconnect the fan from the connector on the system board.

**WARNING:** Ensure not to tilt or rotate the cooling fan while removing from the system.



**Figure 43. Removing a cooling fan**

**Next steps**

1. [Replace a cooling fan.](#)

## Installing a cooling fan

**Prerequisites**

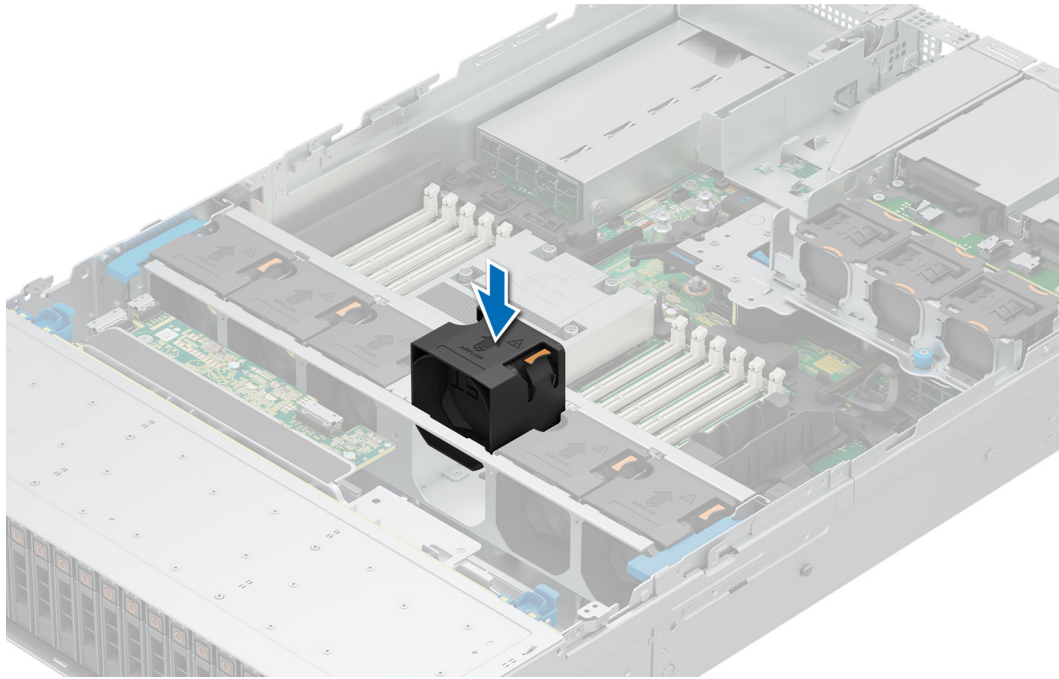
1. Follow the safety guidelines listed in the [Safety instructions](#).
2. Follow the procedure listed in [Before working inside your system](#).

**NOTE:** The procedure to install standard (STD), high-performance silver grade (HPR SLVR), or high-performance gold grade (HPR GOLD) fan is same.

**Steps**

Align and lower the cooling fan into the cooling fan assembly until the fan clicks into place.





**Figure 44. Installing a cooling fan**

**Next steps**

1. Follow the procedure listed in [After working inside your system.](#)

## Removing a 2 x 2.5-inch rear drive module cooling fan

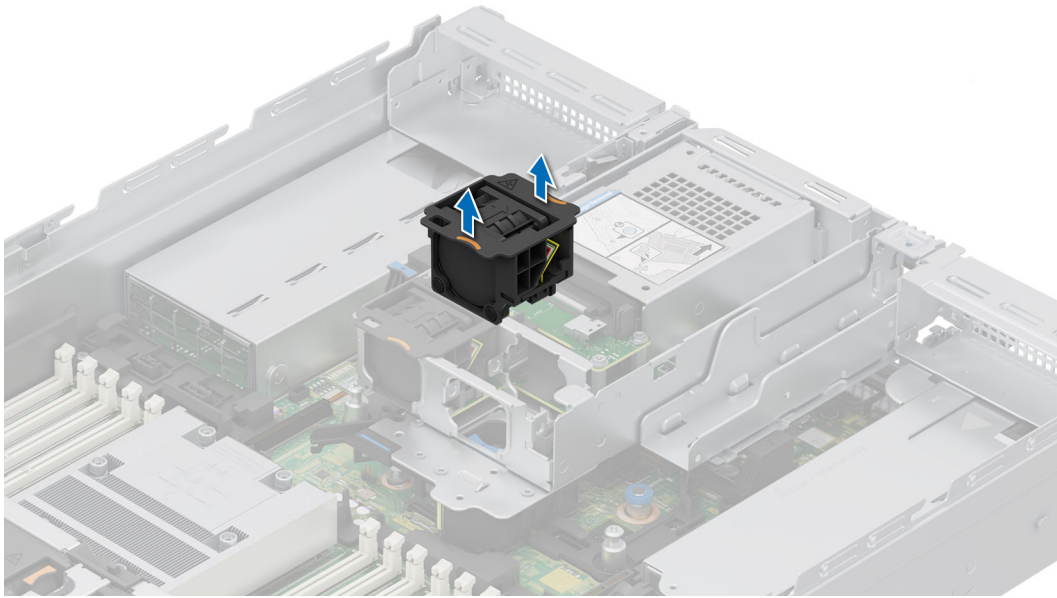
**Prerequisites**

1. Follow the safety guidelines listed in the [Safety instructions.](#)
2. Follow the procedure listed in [Before working inside your system.](#)
3. [Remove the 2 x 2.5-inch rear drive module air shroud.](#)

**Steps**

Press the orange release tab and lift the rear drive module cooling fan to disconnect from the connector on the rear drive module.

**⚠️ WARNING: Ensure not to tilt or rotate the cooling fan while removing from the rear drive module.**



**Figure 45. Removing a 2 x 2.5-inch rear drive module cooling fan**

#### **Next steps**

1. [Replace 2 x 2.5-inch rear drive module cooling fan.](#)

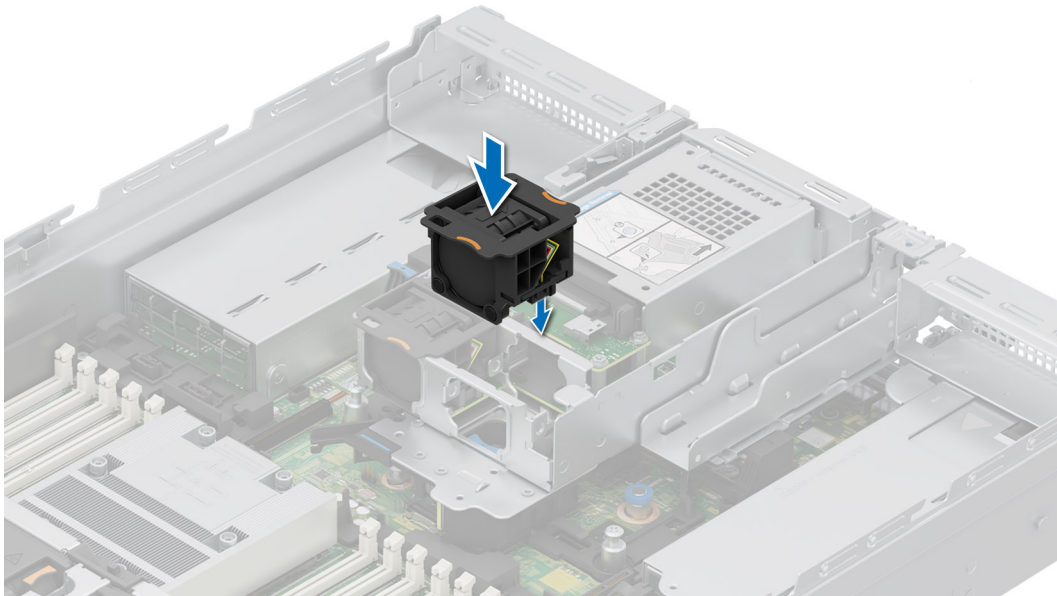
## **Installing a 2 x 2.5-inch rear drive module cooling fan**

#### **Prerequisites**

1. Follow the safety guidelines listed in the [Safety instructions](#).
2. Follow the procedure listed in [Before working inside your system](#).
3. [Remove the 2 x 2.5-inch rear drive module air shroud.](#)

#### **Steps**

Align and lower the rear drive module cooling fan into the rear drive module until the fan clicks into place.



**Figure 46. Installing a 2 x 2.5-inch rear drive module cooling fan**

#### **Next steps**

1. [Install the 2 x 2.5-inch rear drive module air shroud.](#)
2. Follow the procedure listed in [After working inside your system.](#)

## **Removing a 4 x 2.5-inch rear drive module cooling fan**

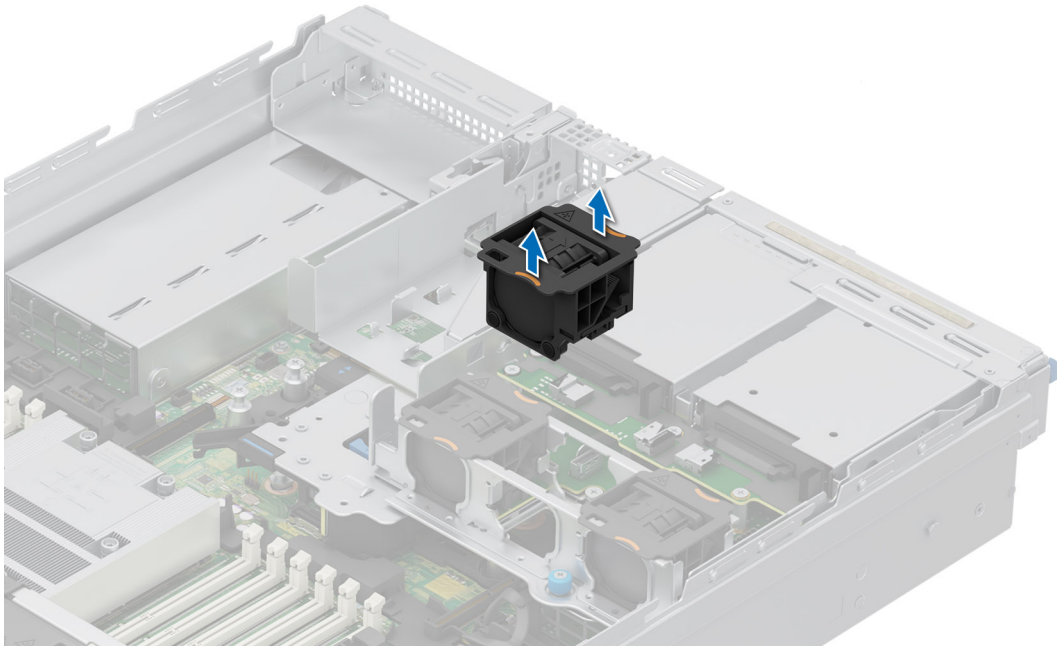
#### **Prerequisites**

1. Follow the safety guidelines listed in the [Safety instructions.](#)
2. Follow the procedure listed in [Before working inside your system.](#)
3. [Remove the 4 x 2.5-inch rear drive module air shroud.](#)

#### **Steps**

Press the orange release tab and lift the rear drive module cooling fan to disconnect from the connector on the rear drive module.

**⚠️ WARNING: Ensure not to tilt or rotate the cooling fan while removing from the rear drive module.**



**Figure 47. Removing a 4 x 2.5-inch rear drive module cooling fan**

#### **Next steps**

1. [Replace 4 x 2.5-inch rear drive module cooling fan.](#)

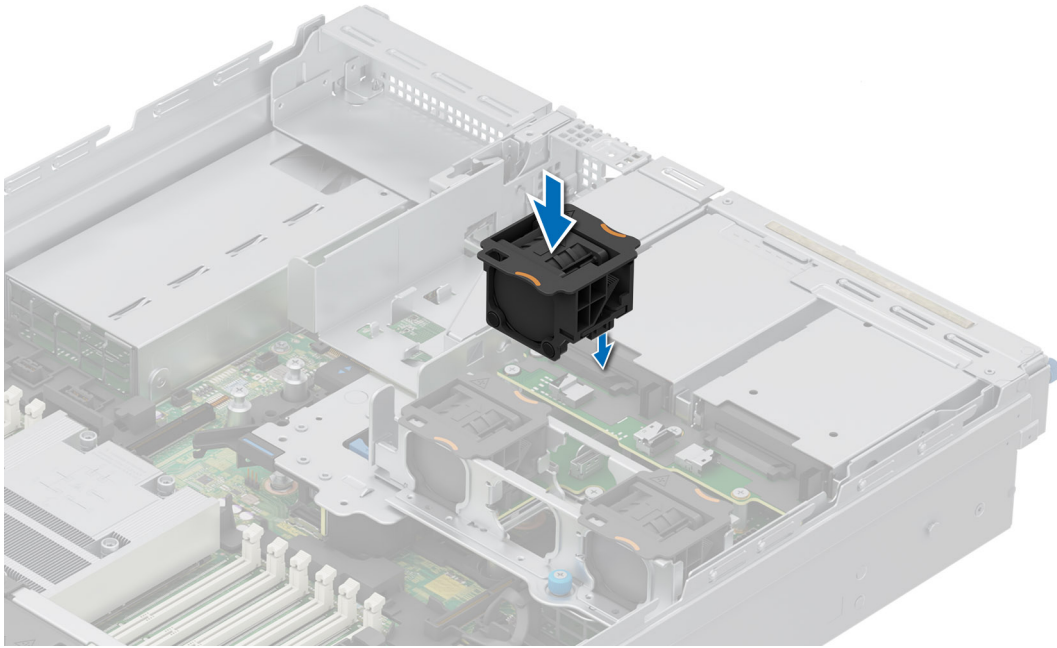
## **Installing a 4 x 2.5-inch rear drive module cooling fan**

#### **Prerequisites**

1. Follow the safety guidelines listed in the [Safety instructions](#).
2. Follow the procedure listed in [Before working inside your system](#).
3. [Remove the 4 x 2.5-inch rear drive module air shroud.](#)

#### **Steps**

Align and lower the rear drive module cooling fan into the rear drive module until the fan clicks into place.



**Figure 48. Installing a 4 x 2.5-inch rear drive module cooling fan**

#### Next steps

1. Install the 4 x 2.5-inch rear drive module air shroud.
2. Follow the procedure listed in [After working inside your system](#).

## Drives

### Removing a drive blank

#### Prerequisites

1. Follow the safety guidelines listed in the [Safety instructions](#).
2. If installed, [remove the front bezel](#).

**CAUTION:** To maintain proper system cooling, drive blanks must be installed in all empty drive slots.

#### Steps

Press the release button, and slide the drive blank out of the drive slot.

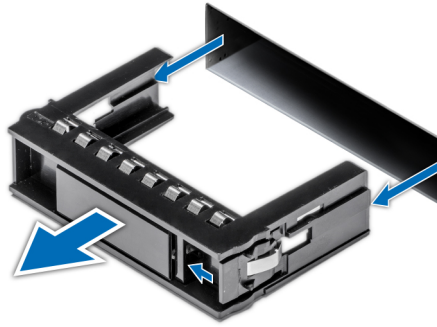


Figure 49. Removing a drive blank

#### Next steps

1. Replace the drive blank.

## Installing a drive blank

#### Prerequisites

1. Follow the safety guidelines listed in the [Safety instructions](#).
2. If installed, [remove the front bezel](#).

#### Steps

Slide the drive blank into the drive slot until the release button clicks into place.

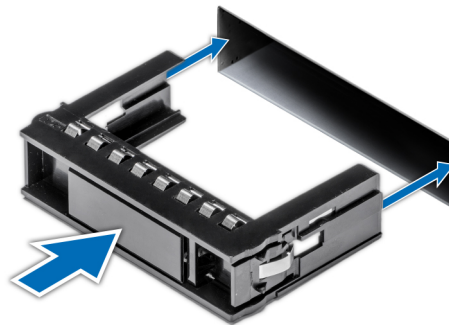


Figure 50. Installing a drive blank

#### Next steps

1. If removed, [install the front bezel](#).

## Removing a drive carrier

#### Prerequisites

1. Follow the safety guidelines listed in [Safety instructions](#).
2. [Remove the front bezel](#).
3. Using the management software, prepare the drive for removal. If the drive is online, the green activity or fault indicator flashes while the drive is turning off. When the drive indicators are off, the drive is ready for removal. For more information, see the storage controller documentation.

**CAUTION:** Before attempting to remove or install a drive while the system is running, see the documentation for the storage controller card to ensure that the host adapter is configured correctly to support drive removal and insertion.

**CAUTION:** To prevent data loss, ensure that your operating system supports drive installation. See the documentation supplied with your operating system.

### Steps

1. Press the release button to open the drive carrier release handle.
2. Holding the drive carrier release handle, slide the drive carrier out of the drive slot.

**NOTE:** If you are not replacing the drive immediately, install a drive blank in the empty drive slot to maintain proper system cooling.



Figure 51. Removing a drive carrier

### Next steps

Replace the drive or a drive blank.

## Installing the drive carrier

### Prerequisites

**CAUTION:** Before removing or installing a drive while the system is running, see the documentation for the storage controller card to ensure that the host adapter is configured correctly to support drive removal and insertion.

**CAUTION:** Combining SAS and SATA drives in the same RAID volume is not supported.

**CAUTION:** When installing a drive, ensure that the adjacent drives are fully installed. Inserting a drive carrier and attempting to lock its handle next to a partially installed carrier can damage the partially installed carrier's shield spring and make it unusable.

**NOTE:** Ensure that the drive carrier's release handle is in the open position before inserting the carrier into the slot.

**CAUTION:** To prevent data loss, ensure that your operating system supports hot-swap drive installation. See the documentation supplied with your operating system.

**CAUTION:** When a replacement hot swappable drive is installed and the system is powered on, the drive automatically begins to rebuild. Ensure that the replacement drive is blank or contains data that you wish to overwrite. Any data on the replacement drive is immediately lost after the drive is installed.

1. Follow the safety guidelines listed in [Safety instructions](#).
2. [Remove the front bezel](#).
3. Remove the drive carrier or remove the drive blank when you want to assemble the drives into the system.

### Steps

1. Slide the drive carrier into the drive slot and push until the drive connects with the backplane.
2. Close the drive carrier release handle to lock the drive in place.



Figure 52. Installing a drive carrier

### Next steps

[install the front bezel](#).

## Removing the drive from the drive carrier

### Prerequisites

1. Follow the safety guidelines listed in the [Safety instructions](#).
2. [Remove the drive carrier](#).

### Steps

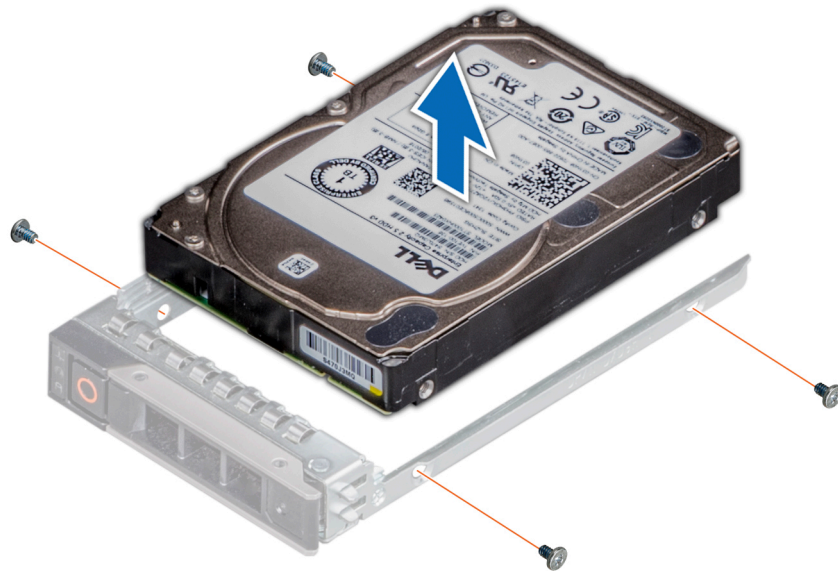
1. Using a Phillips #1 screwdriver, remove the screws from the slide rails on the drive carrier.

**NOTE:** If the drive carrier has Torx screw, use Torx 6 (for 2.5-inch drive) or Torx 8 (for 3.5-inch drive) screwdriver to remove the drive.



2. Lift the drive out of the drive carrier.





**Figure 53. Removing the drive from the drive carrier**

### Next steps

Install the drive into the drive carrier.

## Installing the drive into the drive carrier

### Prerequisites

1. Follow the safety guidelines listed in the [Safety instructions](#).
2. [Remove the drive blank](#).

### Steps

1. Insert the drive into the drive carrier with the drive connector facing towards the rear of the carrier.
2. Align the screw holes on the drive with the screws holes on the drive carrier.
3. Using a Phillips #1 screwdriver, secure the drive to the drive carrier with the screws.

**NOTE:** When installing a drive into the drive carrier, ensure that the screws are torqued to 4 lbf-in.

**NOTE:** If the drive carrier has Torx screw, use Torx 6 (for 2.5-inch drive) or Torx 8 (for 3.5-inch drive) screwdriver to install the drive.





Figure 54. Installing a drive into the drive carrier

#### Next steps

1. [Install the drive carrier.](#)

## Rear drive module

### Removing the 2 x 2.5-inch rear drive module

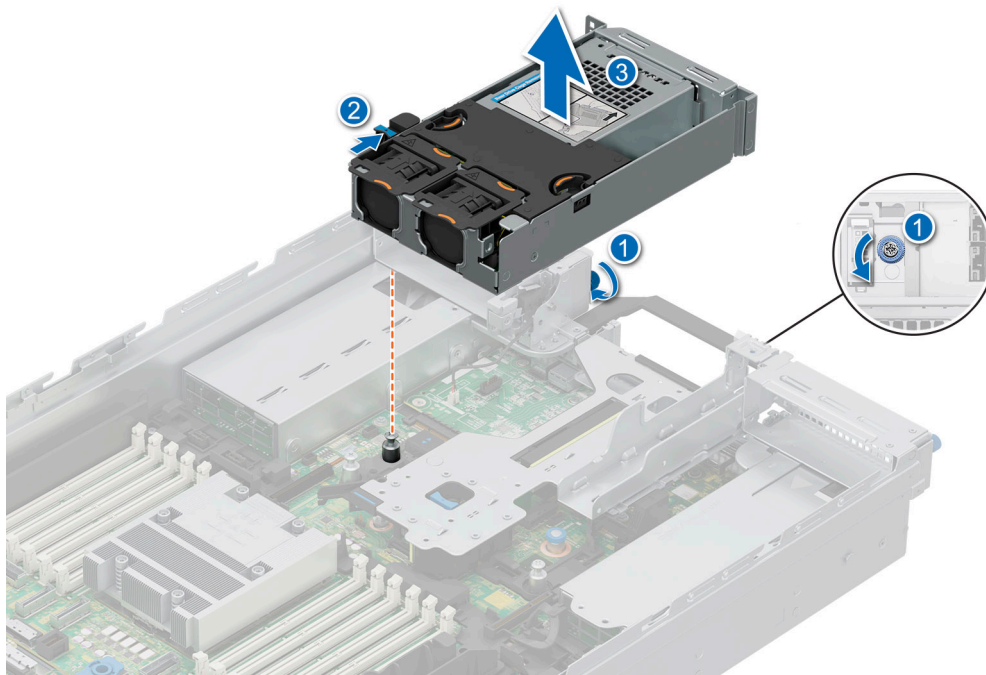
#### Prerequisites

1. Follow the safety guidelines listed in [Safety instructions](#).
2. Follow the procedure listed in [Before working inside your system](#).
3. If required, [remove the air shroud](#).
4. [Remove the drives](#).
5. Disconnect the cables from the rear drive module.

**i** **NOTE:** Refer [Cable routing](#) topic for more information.

#### Steps

1. Using a Phillips #2 screwdriver, loosen the captive screws that secure the rear drive module to the system.
2. Press the blue release tab and holding the edges lift the rear drive module away from the system.



**Figure 55. Removing the 2x 2.5-inch rear drive module**

#### Next steps

1. [Replace the 2 x 2.5-inch rear drive module.](#)

## Installing the 2 x 2.5-inch rear drive module

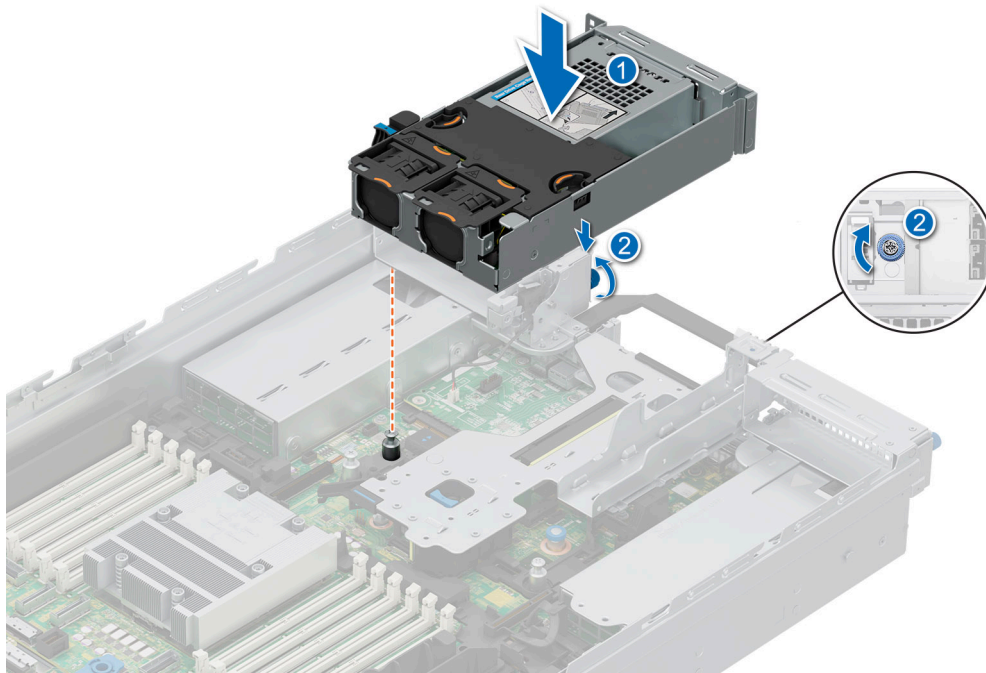
#### Prerequisites

1. Follow the safety guidelines listed in [Safety instructions](#).
2. Follow the procedure listed in [Before working inside your system](#).
3. If required, [remove the air shroud](#).
4. [Remove the drives](#).
5. Disconnect the cables from the rear drive module.

**i** **NOTE:** Refer [Cable routing](#) topic for more information.

#### Steps

1. Align the slot on the rear drive module with the guide on the system.
2. Lower and press the rear drive module on top of the riser until firmly seated.
3. Using a Phillips #2 screwdriver, tighten the captive screws that secure the rear drive module into the system.



**Figure 56. Installing the 2 x 2.5-inch rear drive module**

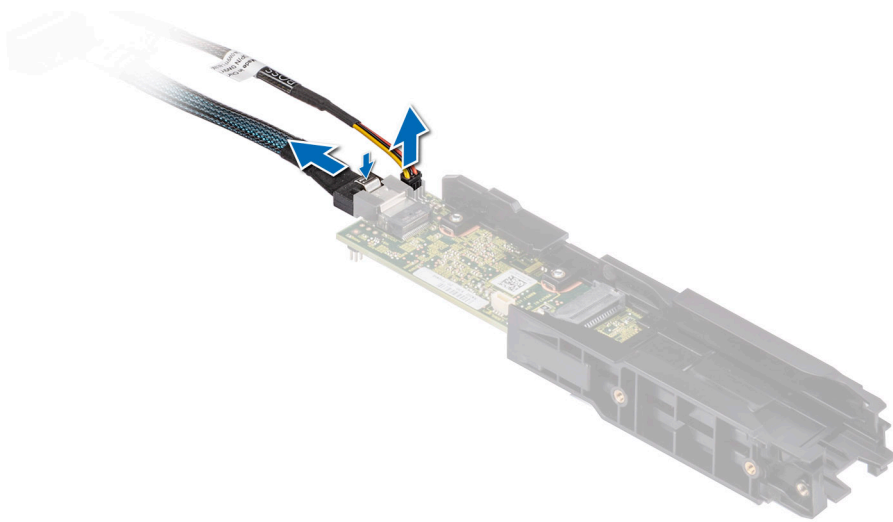
#### Next steps

1. Connect and route all the cables to the rear drive module.
2. [Install the drives.](#)
3. If removed, [install the air shroud.](#)
4. Follow the procedure listed in [After working inside your system.](#)

## Removing the 4 x 2.5-inch rear drive module

#### Prerequisites

1. Follow the safety guidelines listed in [Safety instructions.](#)
2. Follow the procedure listed in [Before working inside your system.](#)
3. If required, [remove the air shroud.](#)
4. [Remove the drives.](#)
5. **i** **NOTE:** If BOSS-N1 module is installed, ensure to disconnect the BOSS-N1 power cable and Signal cable before removing the 4 x 2.5-inch rear drive module.

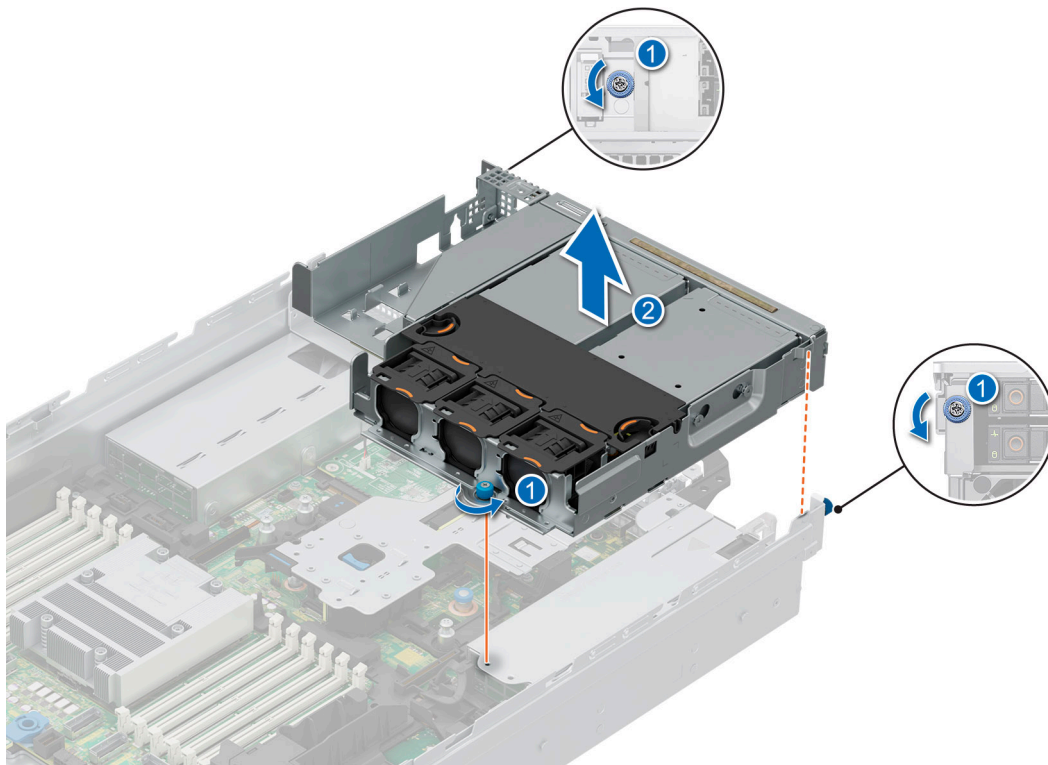


6. Disconnect the cables from the rear drive module.

**i** **NOTE:** Refer [Cable routing](#) topic for more information.

### Steps

1. Using a Phillips #2 screwdriver, loosen the captive screws that secure the rear drive module to the system.
2. Lift the rear drive module from the system.



**Figure 57. Removing the 4 x 2.5-inch rear drive module**

### Next steps

1. [Replace the 4 x 2.5-inch rear drive module.](#)

# Installing the 4 x 2.5-inch rear drive module

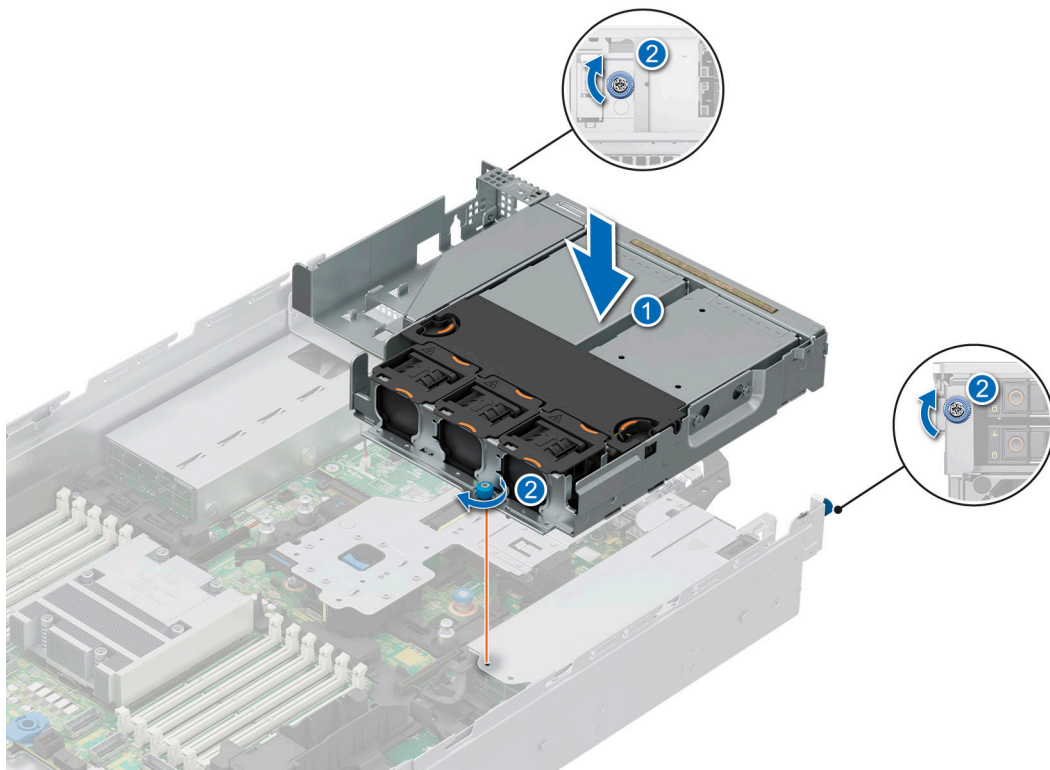
## Prerequisites

1. Follow the safety guidelines listed in [Safety instructions](#).
2. Follow the procedure listed in [Before working inside your system](#).
3. If required, [remove the air shroud](#).
4. [Remove the drives](#).
5. If installed, [remove the BOSS-N1 module](#).
6. Disconnect the cables from the rear drive module.

**i** **NOTE:** Refer [Cable routing](#) topic for more information.

## Steps

1. Align and lower the rear drive module with the guide on the system.
2. Using a Phillips #2 screwdriver, tighten the captive screws that secure the rear drive module into the system.



**Figure 58. Installing the 4 x 2.5-inch rear drive module**

## Next steps

1. Connect and route all the cables to the rear drive module.
2. [Install the drives](#).
3. If removed, [install the BOSS-N1 module](#).
4. If removed, [install the air shroud](#).
5. Follow the procedure listed in [After working inside your system](#).

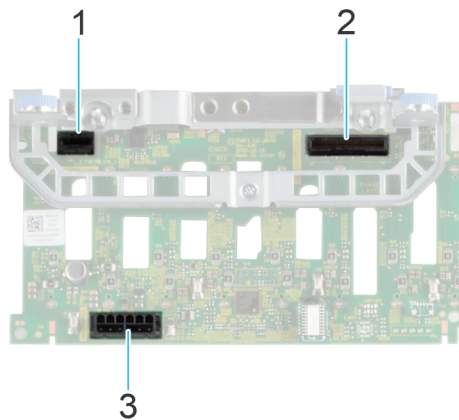
# Drive backplane

## Drive backplane

Depending on your system configuration, the drive backplanes that are supported are listed here:

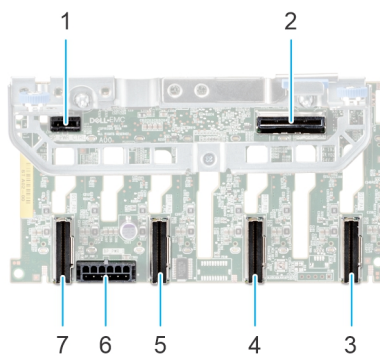
**Table 65. Supported backplane options**

System	Supported hard drives options
PowerEdge R7615	2.5-inch (x 8) NVMe backplane
	2.5-inch (x 8) SAS, or SATA backplane
	3.5-inch (x 8) SAS, or SATA backplane
	3.5-inch (x 12) SAS or SATA backplane
	2.5-inch (x 24) SAS, SATA, or NVMe backplane



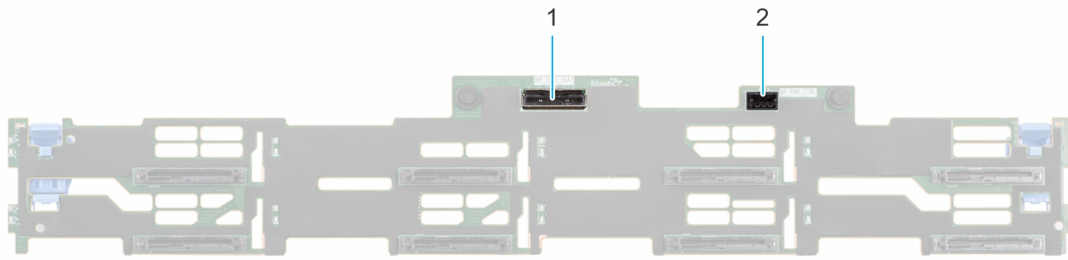
**Figure 59. 8 x 2.5-inch NVMe drive backplane**

1. BP\_PWR\_CTRL
2. BP\_DST\_SA1 (PERC to backplane)
3. BP\_PWR\_1 (backplane power and signal cable to system board)



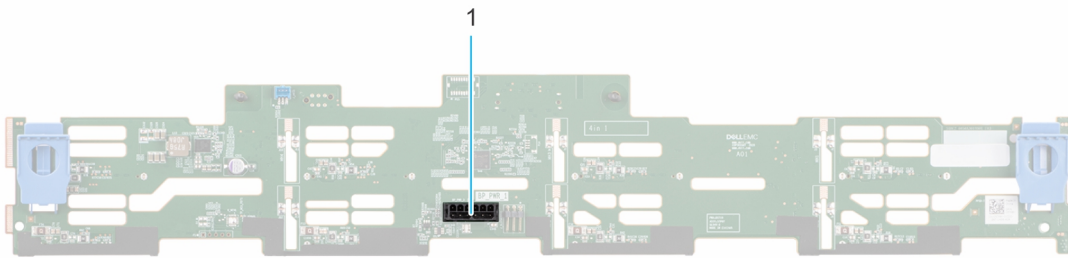
**Figure 60. 8 x 2.5-inch drive backplane**

- |  |   |
|--|---|
| <ol style="list-style-type: none"> <li>1. BP_PWR_CTRL</li> <li>3. BP_DST_PA1 (PCIe/NVMe connector)</li> <li>5. BP_ DST_PA2 (PCIe/NVMe connector)</li> <li>7. BP_DST_PB2 (PCIe/NVMe connector)</li> </ol> | <ol style="list-style-type: none"> <li>2. BP_DST_SA1 (PERC to backplane)</li> <li>4. BP_ DST_PB1 (PCIe/NVMe connector)</li> <li>6. BP_PWR_1 (backplane power and signal cable to system board)</li> </ol> |
|--|---|



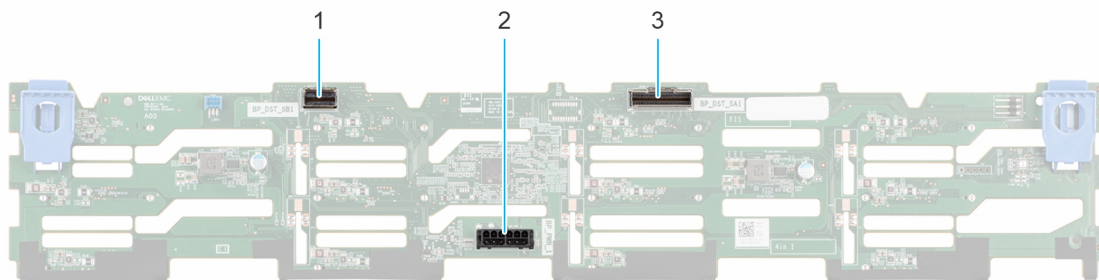
**Figure 61. 8 x 3.5-inch drive backplane rear**

1. BP\_DST\_SA1 (PERC to backplane)
2. BP\_PWR\_CTRL



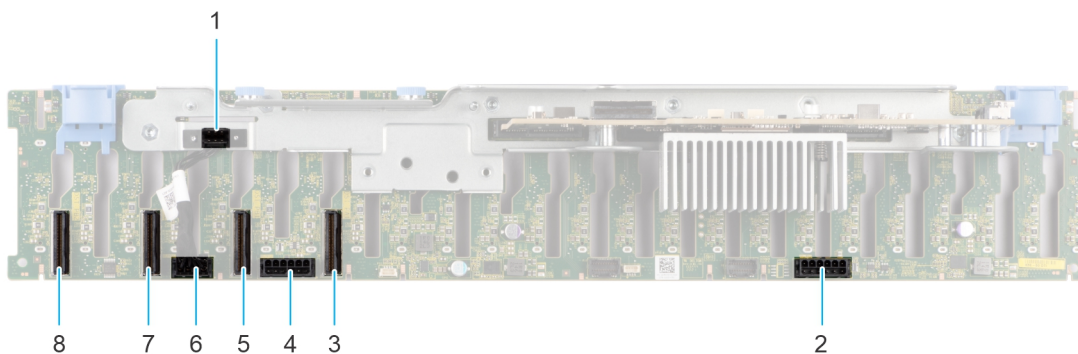
**Figure 62. 8 x 3.5-inch drive backplane front**

1. BP\_PWR\_1 (backplane power and signal cable to system board)



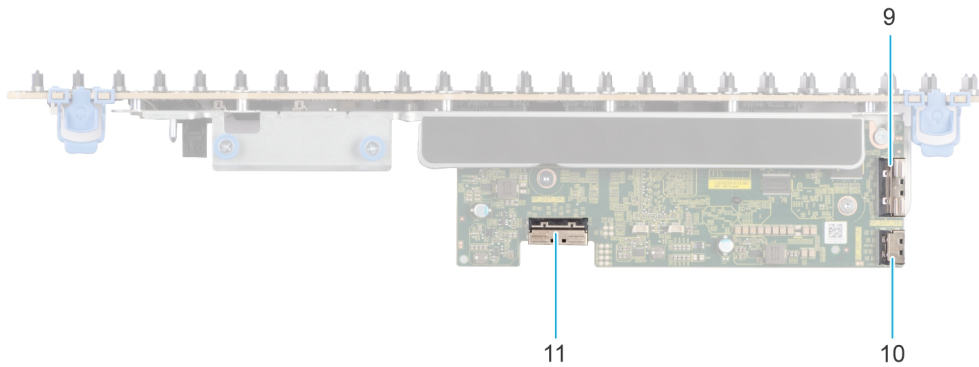
**Figure 63. 12 x 3.5-inch drive backplane**

1. BP\_DST\_SB1
2. BP\_PWR\_1 (backplane power and signal cable to system board)
3. BP\_DST\_SA1



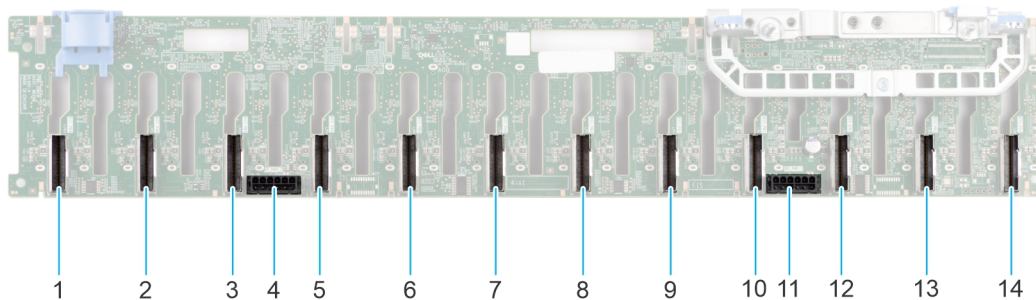
**Figure 64. 24 x 2.5-inch drive backplane (front view)**





**Figure 65. 24 x 2.5-inch drive backplane (top view)**

- |                                     |  |
|-------------------------------------|--|
| 1. BP_CTRL                          | 2. BP_PWR_1 (backplane power and signal cable to system board) |
| 3. BP_DST_PA1 (PCIe/NVMe connector) | 4. BP_PWR_2 (backplane power and signal cable to system board) |
| 5. BP_DST_PB1 (PCIe/NVMe connector) | 6. BP_PWR_CTRL   |
| 7. BP_DST_PA2 (PCIe/NVMe connector) | 8. BP_DST_PB2 (PCIe/NVMe connector)                            |
| 9. BP_DST_SB1                       | 10. BP_SRC_SA2   |
| 11. BP_DST_SA1                      |  |



**Figure 66. 24 x 2.5-inch NVMe passive backplane**

- |                                      |                                      |
|--------------------------------------|--------------------------------------|
| 1. BP_DST_PB6 (PCIe/NVMe connector)  | 2. BP_DST_PA6 (PCIe/NVMe connector)  |
| 3. BP_DST_PB5 (PCIe/NVMe connector)  | 4. BP_PWR_2                          |
| 5. BP_DST_PA5 (PCIe/NVMe connector)  | 6. BP_DST_PB4 (PCIe/NVMe connector)  |
| 7. BP_DST_PA4 (PCIe/NVMe connector)  | 8. BP_DST_PB3 (PCIe/NVMe connector)  |
| 9. BP_DST_PA3 (PCIe/NVMe connector)  | 10. BP_DST_PB2 (PCIe/NVMe connector) |
| 11. BP_PWR_1                         | 12. BP_DST_PA2 (PCIe/NVMe connector) |
| 13. BP_DST_PB1 (PCIe/NVMe connector) | 14. BP_DST_PA1 (PCIe/NVMe connector) |

## Removing the drive backplane

### Prerequisites

**CAUTION:** To prevent damage to the drives and backplane, remove the drives from the system before removing the backplane.

**CAUTION:** Note the number of each drive and temporarily label them before you remove the drive so that you can reinstall them in the same location.

**NOTE:** The procedure to remove the backplane is similar for all backplane configurations.

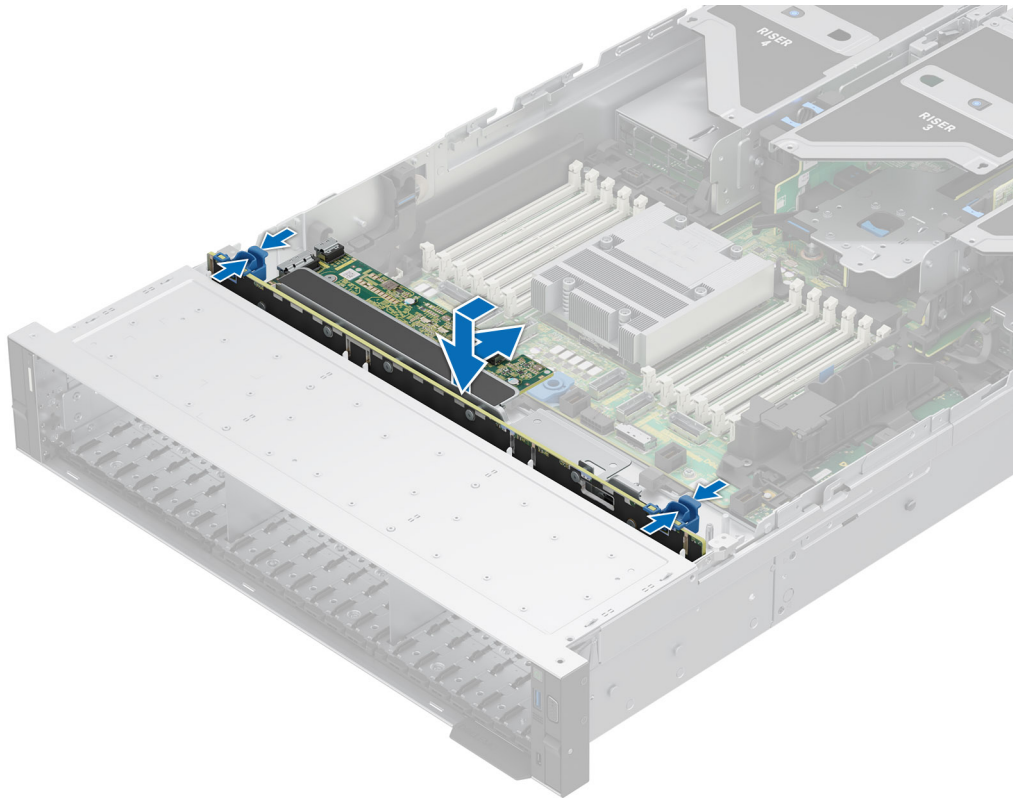
1. Follow the safety guidelines listed in the [Safety instructions](#).
2. Follow the procedure listed in the [Before working inside your system](#).
3. [Remove the backplane cover](#).
4. If installed, [remove the air shroud](#) or [remove the GPU air shroud](#).
5. [Remove the cooling fan cage assembly](#).
6. [Remove the drives](#).
7. Observe and disconnect the drive backplane cables from the connector on the system board and backplane.

**NOTE:** Refer [Cable routing](#) topic for more information.

### Steps

1. Press the release tab to disengage the drive backplane from the hooks on the system.
2. Lift and pull the drive backplane out of the system.

**NOTE:** To avoid damaging the backplane, ensure that you move the control panel cables from the cable routing clips before removing the backplane.



**Figure 67. Removing the drive backplane**

### Next steps

1. [Replace the drive backplane](#).

## Installing the drive backplane

### Prerequisites

1. Follow the safety guidelines listed in the [Safety instructions](#).
2. Follow the procedure listed in the [Before working inside your system](#).
3. [Remove the backplane cover](#).

4. If installed, [remove the air shroud](#) or [remove the GPU air shroud](#).
5. [Remove the cooling fan cage assembly](#).
6. [Remove the drives](#).
7. Observe and disconnect the drive backplane cables from the connector on the system board and backplane.

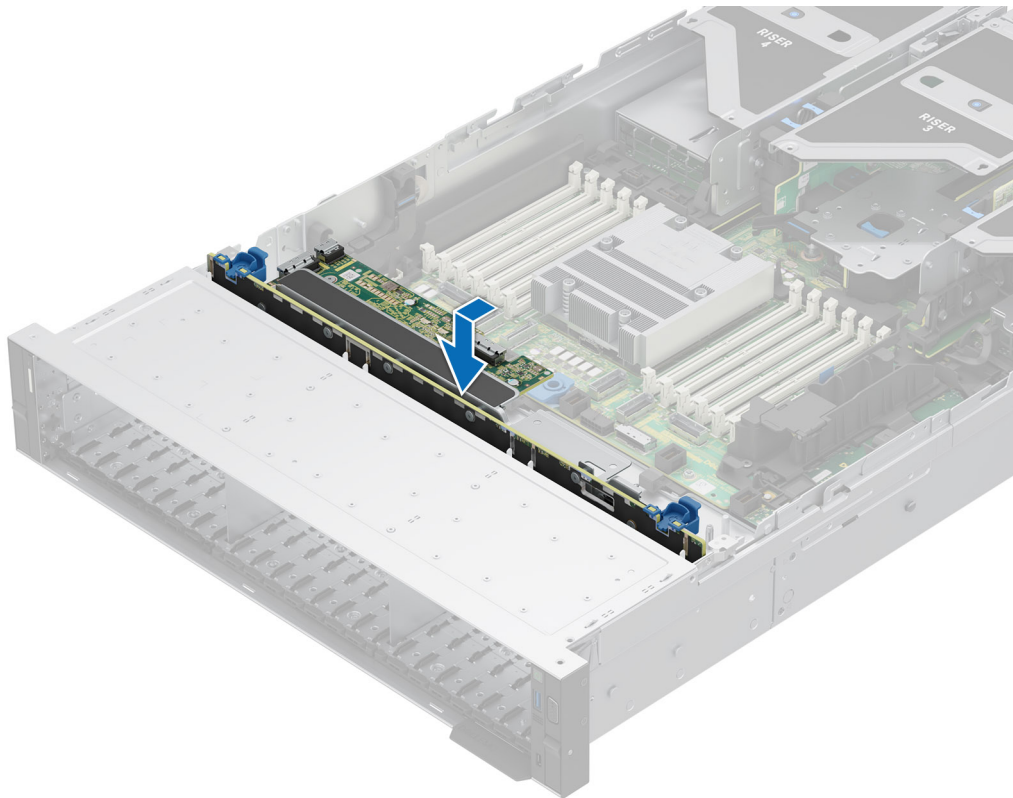
**i** **NOTE:** Refer [Cable routing](#) topic for more information.

**i** **NOTE:** To avoid damaging the backplane, ensure to move the control panel cables from the cable routing clips before removing the backplane.

**i** **NOTE:** Route the cable properly when you replace it to prevent the cable from being pinched or crimped.

### Steps

1. Align the slots on the drive backplane with the guides on the system.
2. Slide the drive backplane into the guides and lower the backplane until the blue release tab clicks into place.



**Figure 68. Installing the drive backplane**

### Next steps

1. Connect the drive backplane cables to the connectors on the system board and backplane.
2. [Install the drives](#).
3. [Install the cooling fan cage assembly](#).
4. If removed, [install the air shroud](#) or [remove the GPU air shroud](#)
5. [Install the drive backplane cover](#).
6. Follow the procedure listed in [After working inside your system](#).

# Side wall brackets

## Removing the side wall bracket

There are two side wall brackets on either side of the system. The procedure to remove is similar.

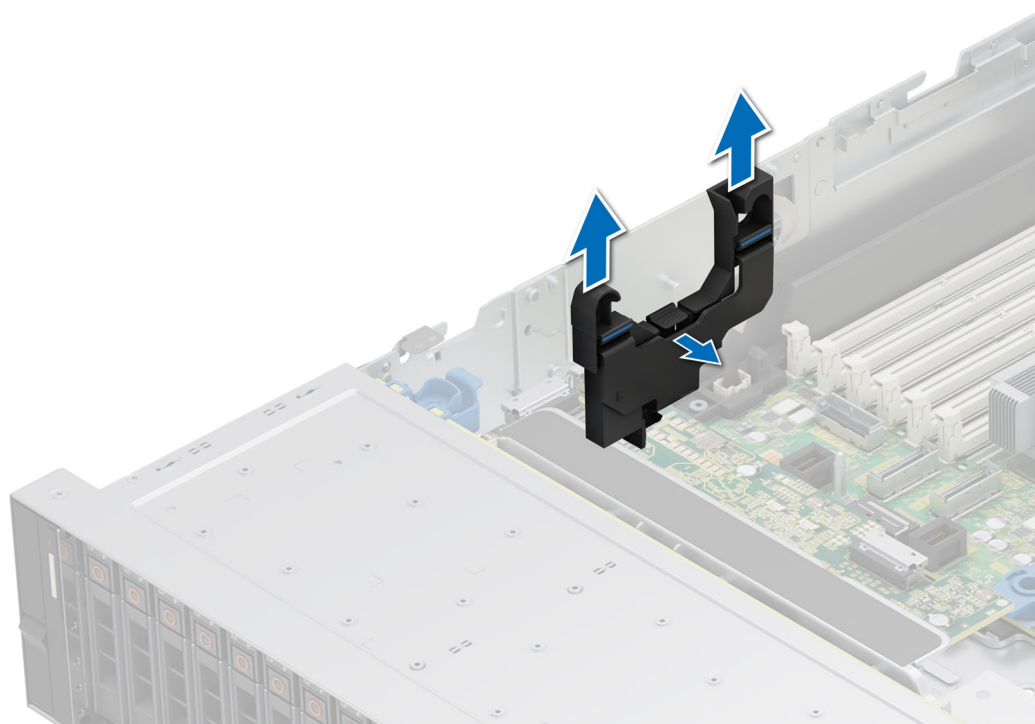
### Prerequisites

1. Follow the safety guidelines listed in the [Safety instructions](#).
2. Follow the procedure listed in the [Before working inside your system](#).
3. If installed, [remove the air shroud](#).
4. [Remove the cooling fan cage assembly](#).

**i** **NOTE:** Ensure that you note the routing of the cables as you remove them from the system board. Route the cables properly when you replace them to prevent the cables from being pinched or crimped.

### Steps

1. Press the blue side tabs to release the side wall cable holder.  
**i** **NOTE:** Move the cables out of the side wall cable holder.
2. Press the center tab to release the bracket from the chassis, and lift it away from the system.



**Figure 69. Removing the side wall bracket**

### Next steps

1. [Replace the side wall bracket](#).

## Installing the side wall bracket

There are two side wall brackets on either side of the system. The procedure to install is similar.

### Prerequisites

1. Follow the safety guidelines listed in the [Safety instructions](#).
2. Follow the procedure listed in the [Before working inside your system](#).
3. If installed, [remove the air shroud](#).
4. [Remove the cooling fan cage assembly](#).

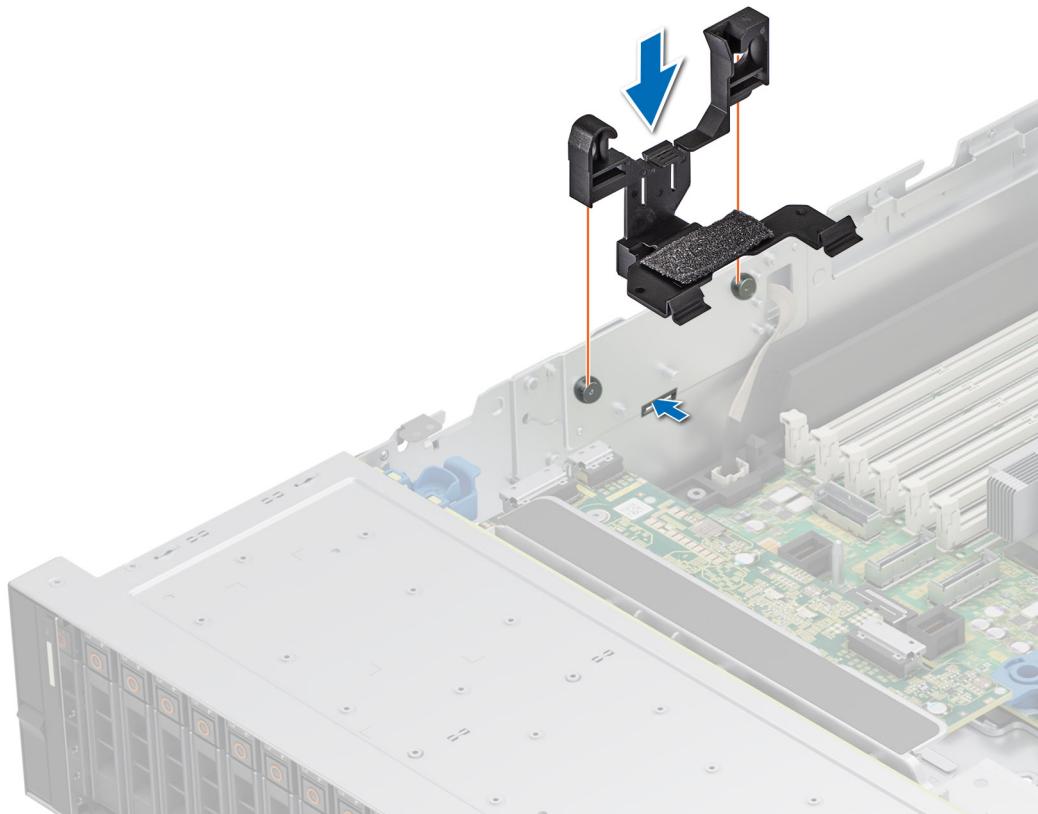
**i** **NOTE:** Ensure that you note the routing of the cables as you remove them from the system board. Route the cables properly when you replace them to prevent the cables from being pinched or crimped.

### Steps

1. Align the guide slots on the side wall bracket with the guides on the system and slide until the cover is seated firmly.

**i** **NOTE:** Route the cables through the side wall cable holder.

2. Close the side wall cable holder until the holder clicks into place.



**Figure 70. Installing the side wall bracket**

### Next steps

1. [Replace the cooling fan cage assembly](#).
2. If removed, [install the air shroud](#).
3. Follow the procedure listed in the [After working inside your system](#).

# Cable routing

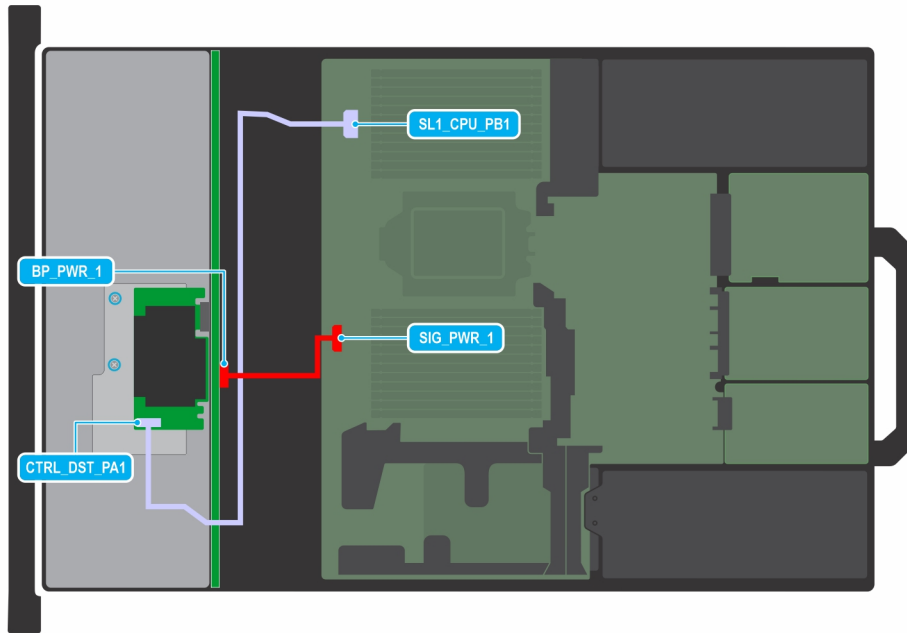
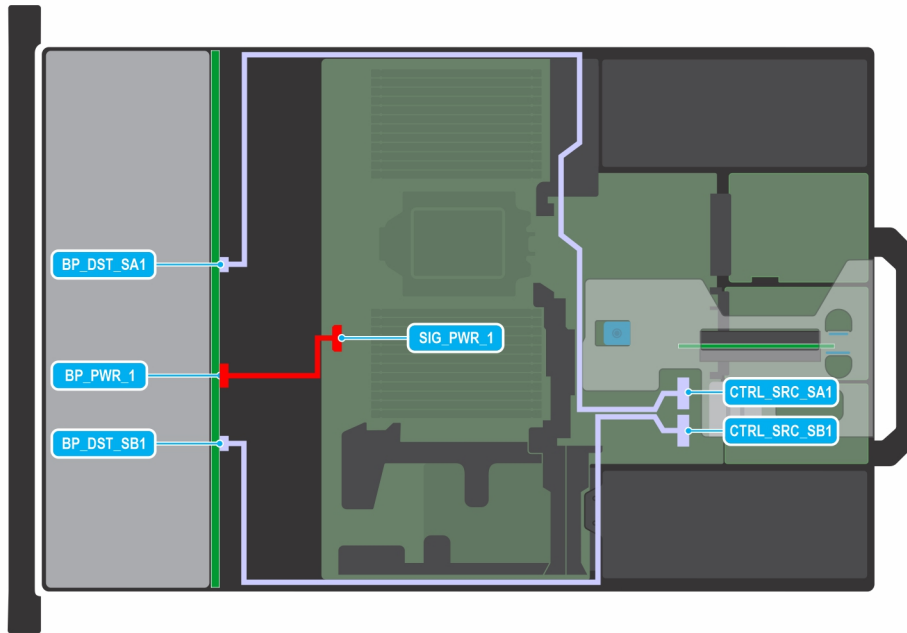


Figure 71. 8 x 3.5 inch SAS/SATA fPERC10.15

**NOTE:** Follow the sequential order as shown in the table to remove the cables, to install the cables follow the reverse sequential order.

Table 66. 8 x 3.5 inch SAS/SATA fPERC

Order	From	To
1	SL1_CPU1_PA1 (signal connector on system board)	CTRL_DST_PA1 (fPERC input connector)
2	SIG_PWR_1 (system board power connector)	BP_PWR_1 (backplane power connector)

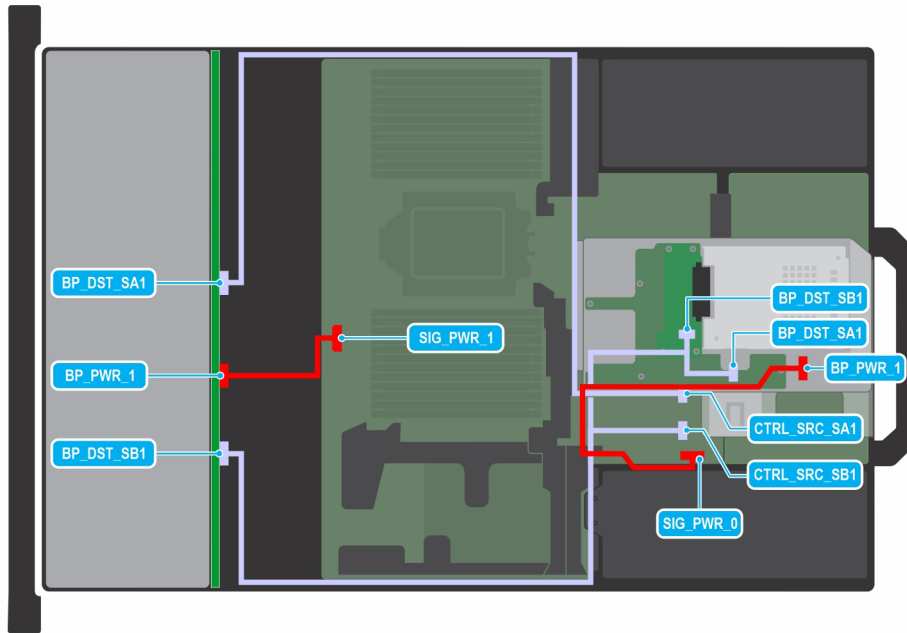


**Figure 72. 12 x 3.5 SAS/SATA with APERC 11 in Riser 2**

**NOTE:** Follow the sequential order as shown in the table to remove the cables, to install the cables follow the reverse sequential order.

**Table 67. 12 x 3.5 SAS/SATA with APERC 11 in Riser 2**

Order	From	To
1	CTRL_SRC_SB1 (fPERC controller connector)	BP_DST_SB1 (backplane signal connector)
2	SIG_PWR_1 (system board power connector)	BP_PWR_1 (backplane power connector)
3	CTRL_SRC_SA1 (fPERC controller connector)	BP_DST_SA1 (backplane signal connector)



**Figure 73. 12 x 3.5 inch SAS/SATA with APERC11 in Riser 2 and Rear 2 x 2.5 inch SAS/SATA**

**NOTE:** Follow the sequential order as shown in the table to remove the cables, to install the cables follow the reverse sequential order.

**Table 68. 12 x 3.5 inch SAS/SATA with APERC11 in Riser 2 and Rear 2 x 2.5 inch SAS/SATA**

Order	From	To
1	CTRL_SRC_SA1 (fPERC controller connector)	BP_DST_SA1 (backplane expander signal connector)
2	SIG_PWR_0 (system board power connector)	BP_PWR_1 (backplane power connector)
3	CTRL_SRC_SB1 (fPERC controller connector)	BP_DST_SA1 and BP_DST_SB1 (backplane expander signal connector)
4	SIG_PWR_1 (system board power connector)	BP_PWR_1 (backplane power connector)



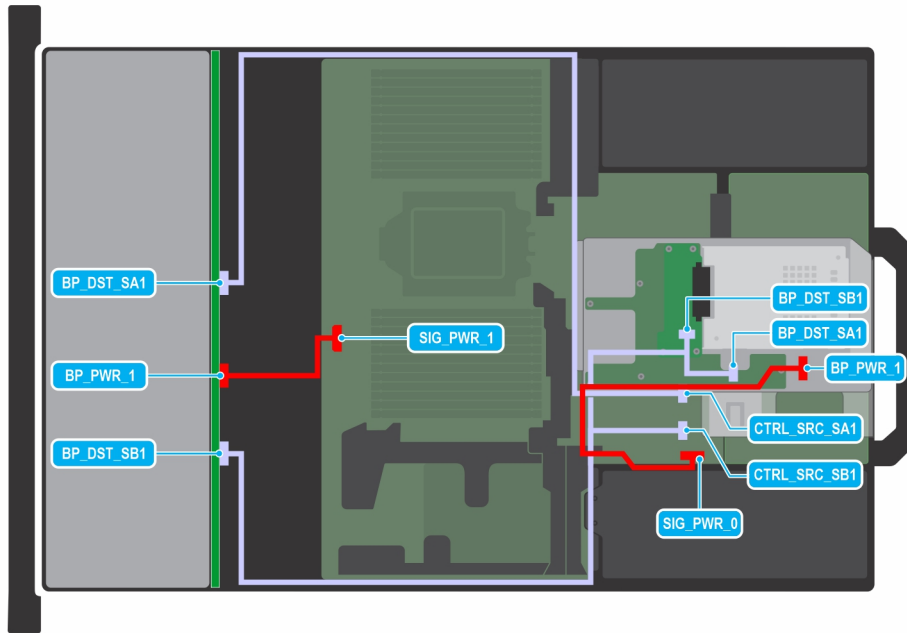
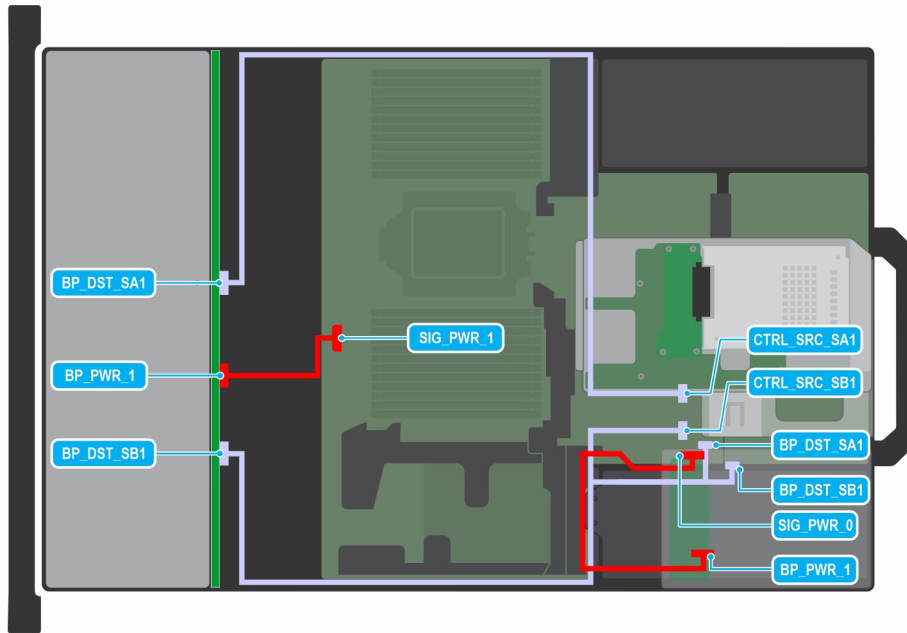


Figure 74. 12 x 3.5 inch SAS/SATA with APERC12 in Riser 2 and Rear 2 x 2.5 inch SAS/SATA

**NOTE:** Follow the sequential order as shown in the table to remove the cables, to install the cables follow the reverse sequential order.

Table 69. 12 x 3.5 inch SAS/SATA with APERC12 in Riser 2 and Rear 2 x 2.5 inch SAS/SATA

Order	From	To
1	CTRL_SRC_SA1 (fPERC controller connector)	BP_DST_SA1 (backplane expander signal connector)
2	SIG_PWR_0 (system board power connector)	BP_PWR_1 (backplane power connector)
3	CTRL_SRC_SB1 (fPERC controller connector)	BP_DST_SA1 and BP_DST_SB1 (backplane expander signal connector)
4	SIG_PWR_1 (system board power connector)	BP_PWR_1 (backplane power connector)



**Figure 75. 12 x 3.5 inch SAS/SATA with APERC11 in Riser 2 and Rear 4 x 2.5 inch SAS/SATA**

**NOTE:** Follow the sequential order as shown in the table to remove the cables, to install the cables follow the reverse sequential order.

**Table 70. 12 x 3.5 inch SAS/SATA with APERC11 in Riser 2 and Rear 4 x 2.5 inch SAS/SATA**

Order	From	To
1	SIG_PWR_0 (system board power connector)	BP_PWR_1 (backplane power connector)
2	CTRL_SRC_SA1 (fPERC controller connector)	BP_DST_SA1 (backplane expander signal connector)
3	CTRL_SRC_SB1 (fPERC controller connector)	BP_DST_SA1 and BP_DST_SB1 (backplane expander signal connector)
4	SIG_PWR_1 (system board power connector)	BP_PWR_1 (backplane power connector)

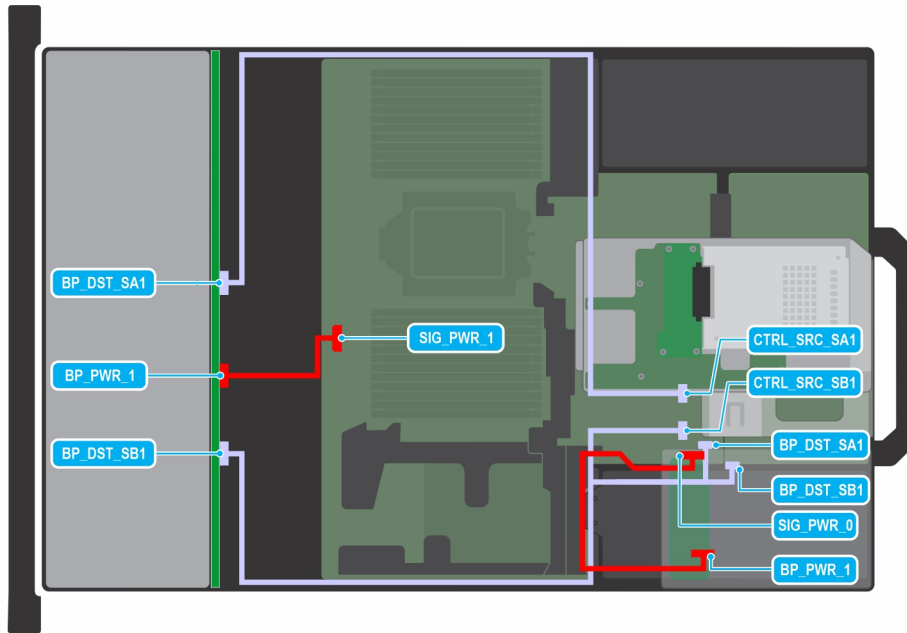
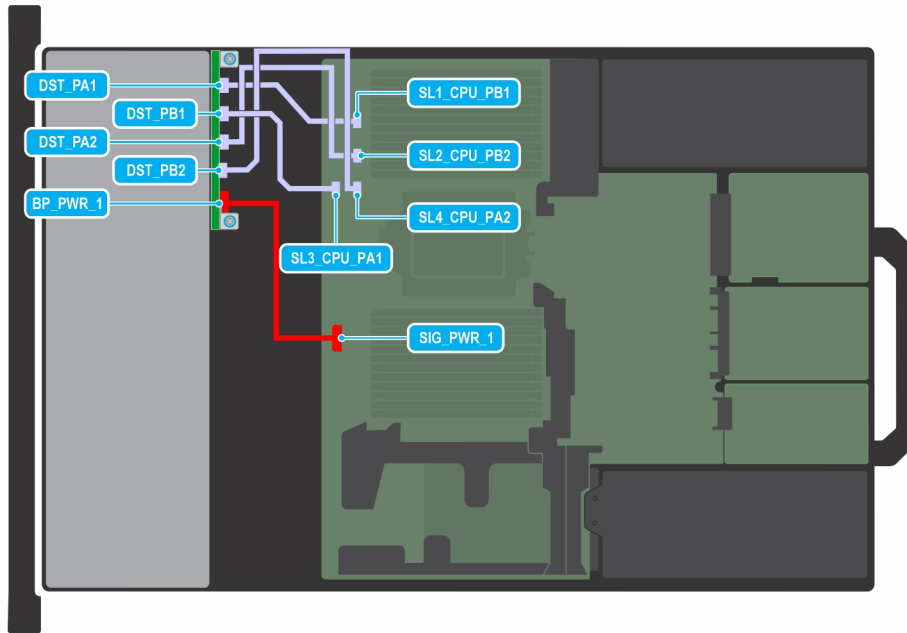


Figure 76. 12 x 3.5 inch SAS/SATA with APERC12 in Riser 2 and Rear 4 x 2.5 inch SAS/SATA

**NOTE:** Follow the sequential order as shown in the table to remove the cables, to install the cables follow the reverse sequential order.

Table 71. 12 x 3.5 inch SAS/SATA with APERC12 in Riser 2 and Rear 4 x 2.5 inch SAS/SATA

Order	From	To
1	SIG_PWR_0 (system board power connector)	BP_PWR_1 (backplane power connector)
2	CTRL_SRC_SA1 (fPERC controller connector)	BP_DST_SA1 (backplane expander signal connector)
3	CTRL_SRC_SB1 (fPERC controller connector)	BP_DST_SA1 and BP_DST_SB1 (backplane expander signal connector)
4	SIG_PWR_1 (system board power connector)	BP_PWR_1 (backplane power connector)

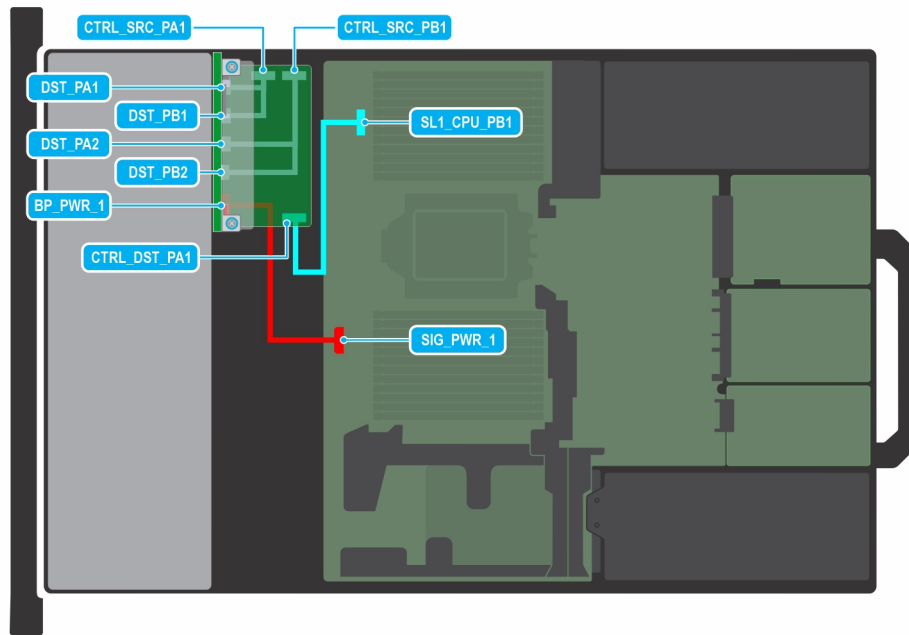


**Figure 77. 8 x 2.5 inch x4 PCIe U.2 NVMe SSD**

**NOTE:** Follow the sequential order as shown in the table to remove the cables, to install the cables follow the reverse sequential order.

**Table 72. 8 x 2.5 inch x4 PCIe U.2 NVMe SSD**

Order	From	To
1	SIG_PWR_1 (system board power connector)	BP_PWR_1 (backplane power connector)
2	SL4_CPU1_PB1 (signal connector on system board)	DST_PB2 (backplane signal connector)
3	SL2_CPU1_PB4 (signal connector on system board)	DST_PA2 (backplane signal connector)
4	SL1_CPU1_PA4 (signal connector on system board)	DST_PA1 (backplane signal connector)
5	SL3_CPU1_PA1 (signal connector on system board)	DST_PB1 (backplane signal connector)

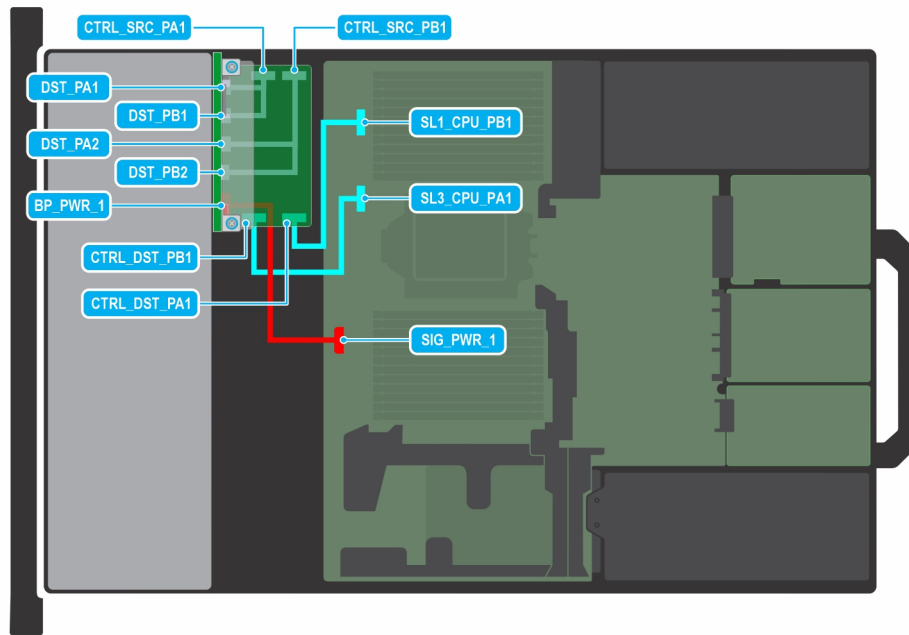


**Figure 78. 8 x 2.5 inch x4 PCIe U.2 NVMe SSD with FPERC11**

**NOTE:** Follow the sequential order as shown in the table to remove the cables, to install the cables follow the reverse sequential order.

**Table 73. 8 x 2.5 inch x4 PCIe U.2 NVMe SSD with FPERC11**

Order	From	To
1	SIG_PWR_1 (system board power connector)	BP_PWR_1 (backplane power connector)
2	SL1_CPU1_PB2 (signal connector on system board)	CTRL_DST_PA1 (fPERC input connector)
3	CTRL_SRC_PB1 (fPERC controller connector)	DST_PA2 and DST_PB2 (backplane signal connector)
4	CTRL_SRC_PA1 (fPERC controller connector)	DST_PA1 and DST_PB1 (backplane signal connector)

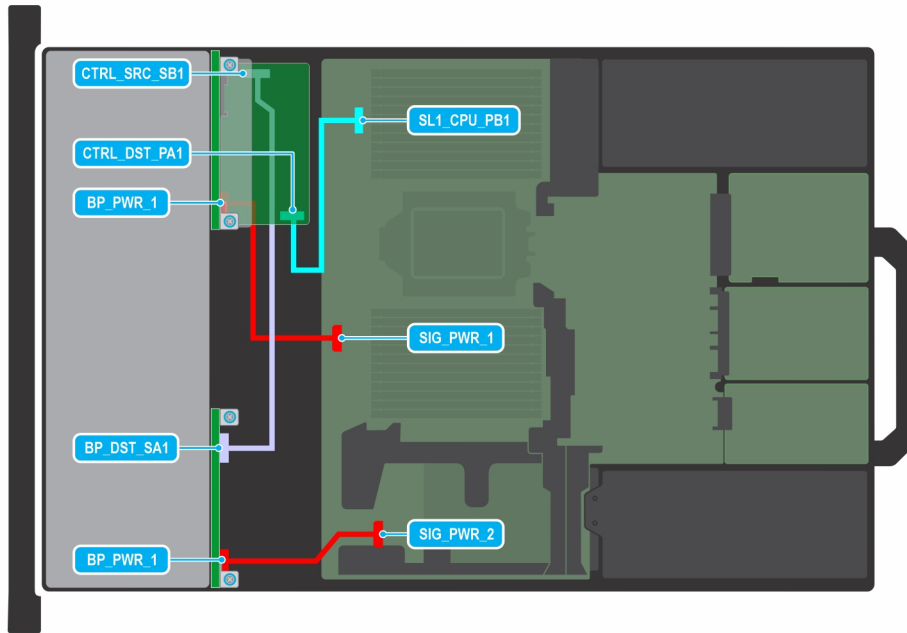


**Figure 79. 8 x 2.5 inch x4 PCIe U.2 NVMe SSD with FPERC12**

**NOTE:** Follow the sequential order as shown in the table to remove the cables, to install the cables follow the reverse sequential order.

**Table 74. 8 x 2.5 inch x4 PCIe U.2 NVMe SSD with FPERC12**

Order	From	To
1	SIG_PWR_1 (system board power connector)	BP_PWR_1 (backplane power connector)
2	SL1_CPU1_PB2 (signal connector on system board)	CTRL_DST_PA1 (fPERC input connector)
3	SL3_CPU1_PB2 (signal connector on system board)	CTRL_DST_PB1 (fPERC input connector)
4	CTRL_SRC_PB1 (fPERC controller connector)	DST_PA2 and DST_PB2 (backplane signal connector)
5	CTRL_SRC_PA1 (fPERC controller connector)	DST_PA1 and DST_PB1 (backplane signal connector)

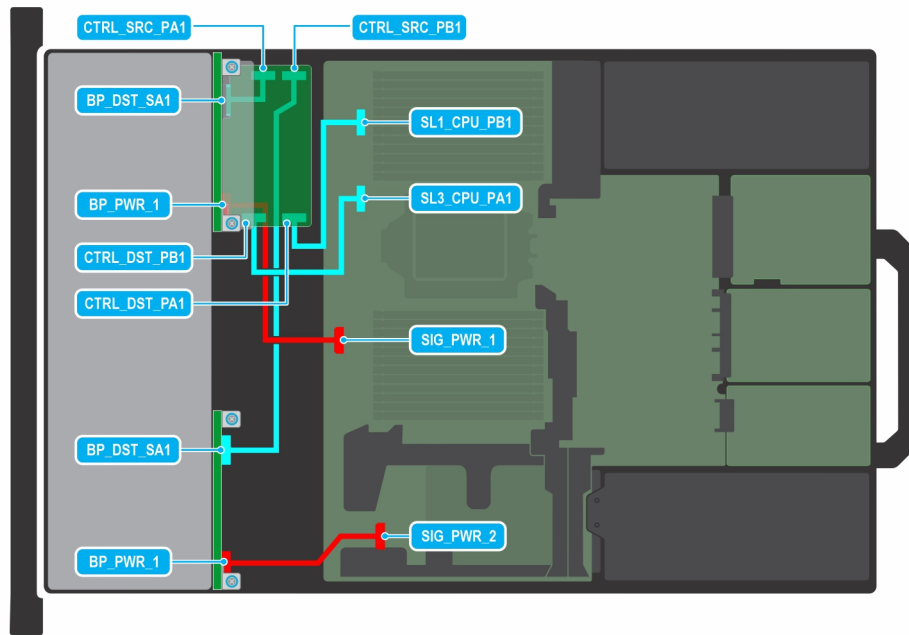


**Figure 80. 8 x 2.5 inch Universal SAS3 Low Profile with FPERC11**

**NOTE:** Follow the sequential order as shown in the table to remove the cables, to install the cables follow the reverse sequential order.

**Table 75. 8 x 2.5 inch Universal SAS3 Low Profile with FPERC11**

Order	From	To
1	SIG_PWR_2 (system board power connector)	BP_PWR_1(backplane power connector)
2	SIG_PWR_1(system board power connector)	BP_PWR_1(backplane power connector)
3	CTRL_SRC_SB1 (fPERC controller connector)	BP_DST_SA1 (backplane signal connector)
4	SL1_CPU1_PB2 (signal connector on system board)	CTRL_DST_PA1 (fPERC input connector)



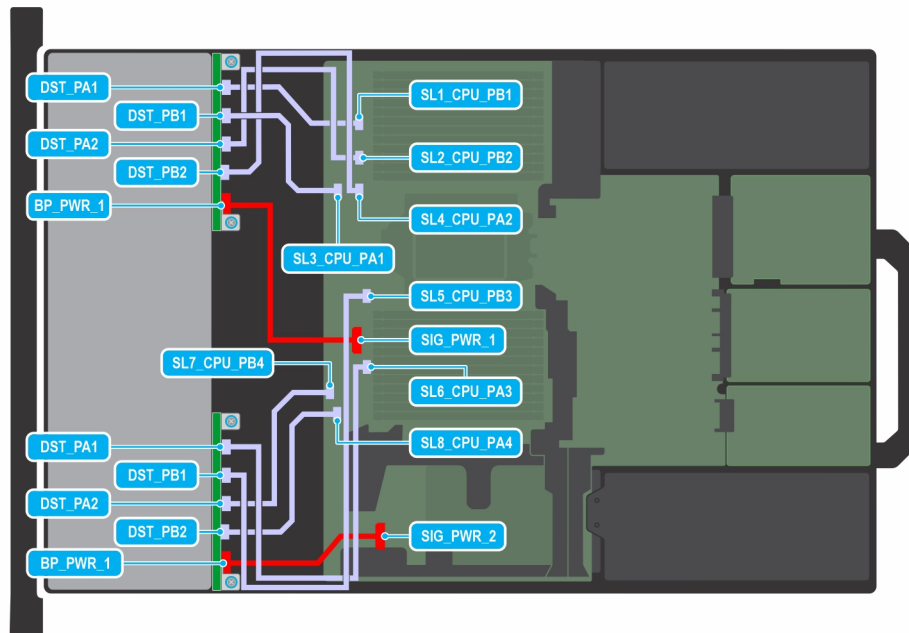
**Figure 81. 16 x 2.5 inch SAS/SATA Low Profile with FPERC11**

**NOTE:** Follow the sequential order as shown in the table to remove the cables, to install the cables follow the reverse sequential order.

**Table 76. 16 x 2.5 inch SAS/SATA Low Profile with FPERC11**

Order	From	To
1	SIG_PWR_2 (system board power connector)	BP_PWR_1 (backplane power connector)
2	SIG_PWR_1 (system board power connector)	BP_PWR_1 (backplane power connector)
3	CTRL_SRC_PB1 (fPERC controller connector)	BP_DST_SA1 (backplane signal connector)
4	SL3_CPU1_PB2 (signal connector on system board)	CTRL_DST_PB1 (fPERC input connector)
5	SL1_CPU1_PB2 (signal connector on system board)	CTRL_DST_PA1 (fPERC input connector)
6	CTRL_SRC_PA1 (fPERC controller connector)	BP_DST_SA1 (backplane signal connector)



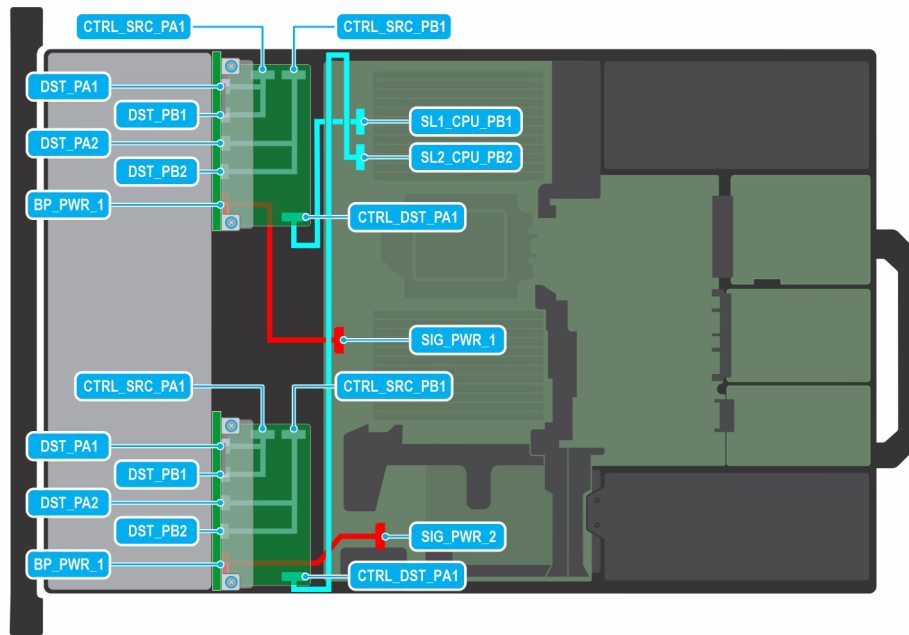


**Figure 82. 16 x 2.5 inch SAS/SATA Low Profile with FPERC12**

**NOTE:** Follow the sequential order as shown in the table to remove the cables, to install the cables follow the reverse sequential order.

**Table 77. 16 x 2.5 inch SAS/SATA Low Profile with FPERC12**

Order	From	To
1	SIG_PWR_2 (system board power connector)	BP_PWR_1 (backplane power connector)
2	SIG_PWR_1 (system board power connector)	BP_PWR_1 (backplane power connector)
3	SL5_CPU1_PB2 (signal connector on system board)	DST_PB1 (backplane signal connector)
4	SL6_CPU1_PA4 (signal connector on system board)	DST_PA1 (backplane signal connector)
5	SL8_CPU1_PA4 (signal connector on system board)	DST_PB2 (backplane signal connector)
6	SL7_CPU1_PA4 (signal connector on system board)	DST_PA2 (backplane signal connector)
7	SL4_CPU_1_PB1 (signal connector on system board)	DST_PB2 (backplane signal connector)
8	SL2_CPU1_PB4 (signal connector on system board)	DST_PA2 (backplane signal connector)
9	SL1_CPU1_PA4 (signal connector on system board)	DST_PA1 (backplane signal connector)
10	SL3_CPU1_PA1 (signal connector on system board)	DST_PB1 (backplane signal connector)

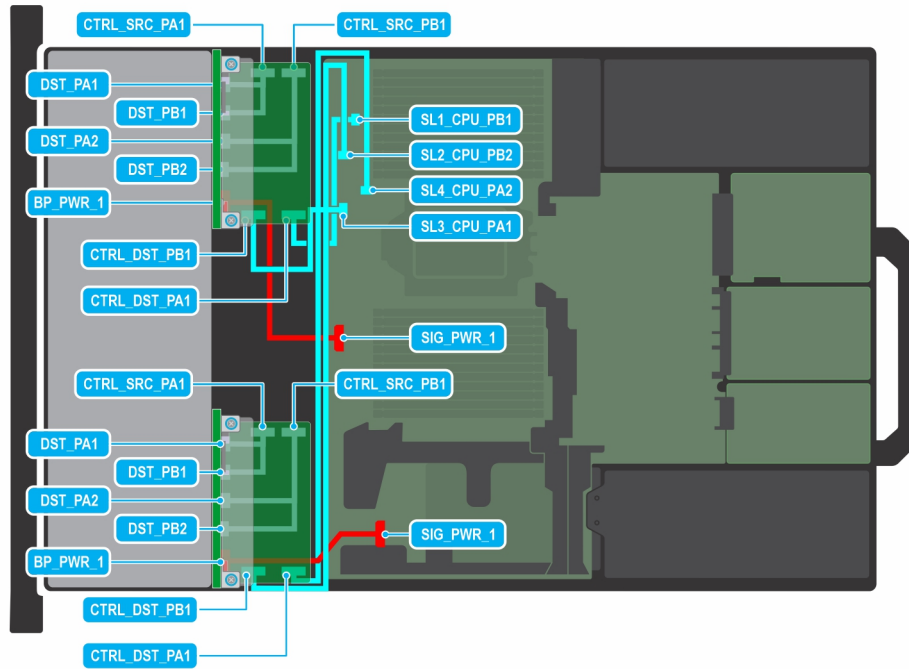


**Figure 83. 16 x U.2 Gen4 Low Profile**

**NOTE:** Follow the sequential order as shown in the table to remove the cables, to install the cables follow the reverse sequential order.

**Table 78. 16 x U.2 Gen4 Low Profile**

Order	From	To
1	SIG_PWR_2 (system board power connector)	BP_PWR_1 (backplane power connector)
2	SIG_PWR_1(system board power connector)	BP_PWR_1 (backplane power connector)
3	SL1_CPU1_PB2 (signal connector on system board)	CTRL_DST_PA1 (fPERC input connector)
4	SL2_CPU1_PB2 (signal connector on system board)	CTRL_DST_PA1 (fPERC input connector)
5	CTRL_SRC_PB1 (fPERC controller connector)	DST_PA2 and DST_PB2 (backplane signal connector)
6	CTRL_SRC_PB1 (fPERC controller connector)	DST_PA2 and DST_PB2 (backplane signal connector)
7	CTRL_SRC_PA1 (fPERC controller connector)	DST_PA1 and DST_PB1 (backplane signal connector)
8	CTRL_SRC_PA1 (fPERC controller connector)	DST_PA1 and DST_PB1 (backplane signal connector)

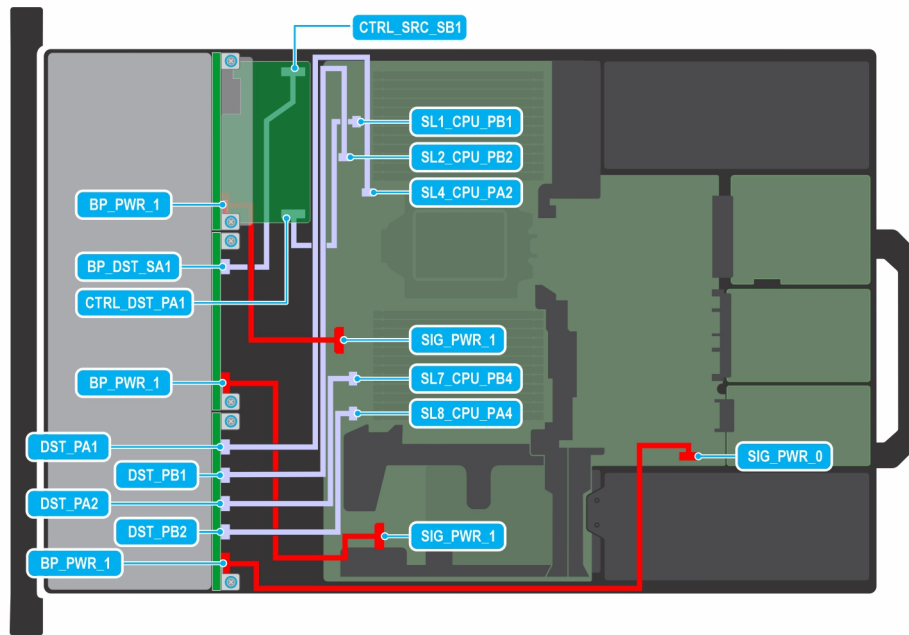


**Figure 84. 16 x 2.5 inch U.2 Gen4 Low Profile with 2 x FPERC11**

**NOTE:** Follow the sequential order as shown in the table to remove the cables, to install the cables follow the reverse sequential order.

**Table 79. 16 x 2.5 inch U.2 Gen4 Low Profile with 2 x FPERC11**

Order	From	To
1	SIG_PWR_1 (system board power connector)	BP_PWR_1 (backplane power connector)
2	SIG_PWR_1 (system board power connector)	BP_PWR_1 (backplane power connector)
3	CTRL_DST_PA1 (fPERC input connector)	SL4_CPU1_PB2 (signal connector on system board)
4	CTRL_DST_PB1 (fPERC input connector)	SL2_CPU1_PB2 (signal connector on system board)
5	CTRL_SRC_PB1 (fPERC controller connector)	DST_PA2 and DST_PB2 (backplane signal connector)
6	CTRL_SRC_PA1 (fPERC controller connector)	DST_PA1 and DST_PB1 (backplane signal connector)
7	SL1_CPU1_PB2 (signal connector on system board)	CTRL_DST_PA1 (fPERC input connector)
8	SL3_CPU1_PB2 (signal connector on system board)	CTRL_DST_PB1 (fPERC input connector)
9	CTRL_SRC_PB1 (fPERC controller connector)	DST_PA2 and DST_PB2 (backplane signal connector)
10	CTRL_SRC_PA1 (fPERC controller connector)	DST_PA1 and DST_PB1 (backplane signal connector)

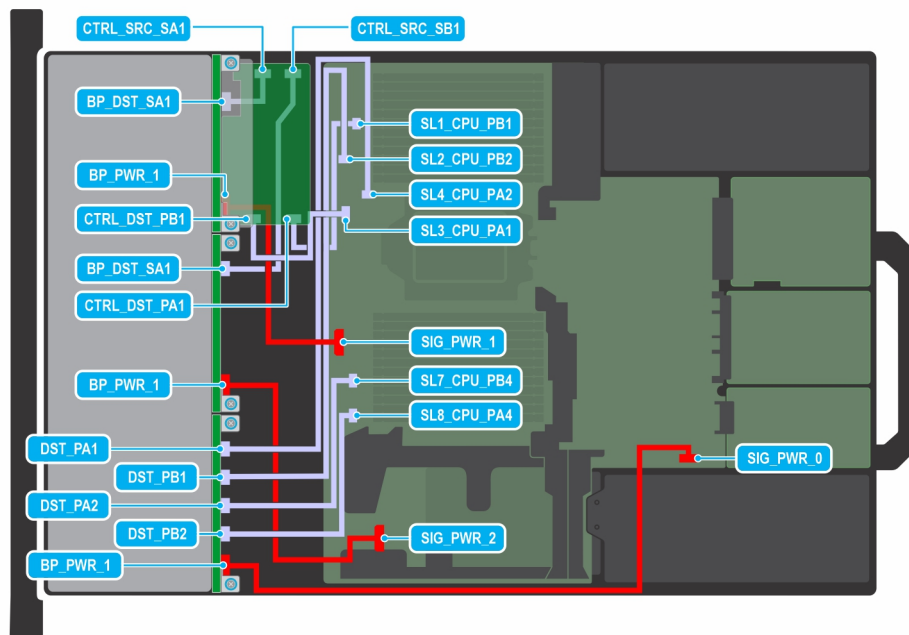


**Figure 85. 16 x 2.5 inch SAS/SATA with FPERC11 + 8 x U.2 Gen4**

**NOTE:** Follow the sequential order as shown in the table to remove the cables, to install the cables follow the reverse sequential order.

**Table 80. 16 x 2.5 inch SAS/SATA with FPERC11 + 8 x U.2 Gen4**

Order	From	To
1	SIG_PWR_0 (system board power connector)	BP_PWR_1 (backplane power connector)
2	SIG_PWR_1 (system board power connector)	BP_PWR_1 (backplane power connector)
3	SIG_PWR_1 (system board power connector)	BP_PWR_1 (backplane power connector)
4	SL8_CPU1_PA4 (signal connector on system board)	DST_PB2 (backplane signal connector)
5	SL7_CPU1_PB4 (signal connector on system board)	DST_PA2 (backplane signal connector)
6	SL2_CPU1_PB2 (signal connector on system board)	DST_PB1 (backplane signal connector)
7	SL4_CPU1_PB2 (signal connector on system board)	DST_PA1 (backplane signal connector)
8	SL1_CPU1_PB2 (signal connector on system board)	CTRL_DST_PA1 (fPERC input connector)
9	CTRL_SRC_SB1 (fPERC controller connector)	BP_DST_PA1 (backplane signal connector)

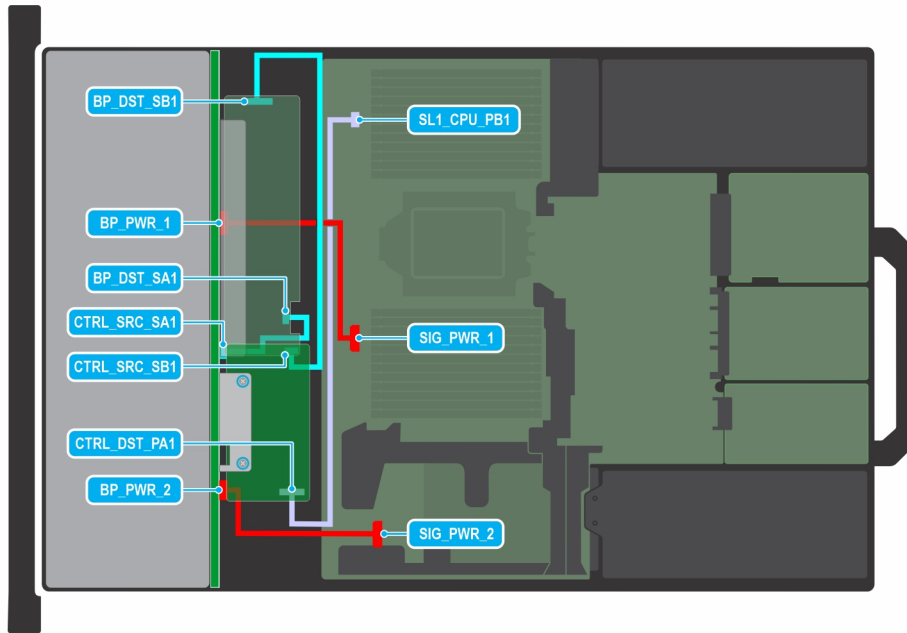


**Figure 86. 16 x 2.5 inch SAS/SATA with FPERC12 + 8 x U.2 Gen4**

**NOTE:** Follow the sequential order as shown in the table to remove the cables, to install the cables follow the reverse sequential order.

**Table 81. 16 x 2.5 inch SAS/SATA with FPERC12 + 8 x U.2 Gen4**

Order	From	To
1	SIG_PWR_0 (system board power connector)	BP_PWR_1 (backplane power connector)
2	SIG_PWR_2 (system board power connector)	BP_PWR_1 (backplane power connector)
3	SL8_CPU1_PA4 (signal connector on system board)	DST_PB2 (backplane signal connector)
4	SL7_CPU1_PB4 (signal connector on system board)	DST_PA2 (backplane signal connector)
5	SL4_CPU1_PB2 (signal connector on system board)	DST_PA1 (backplane signal connector)
6	SL2_CPU1_PB2 (signal connector on system board)	DST_PB1 (backplane signal connector)
7	SL3_CPU1_PB2 (signal connector on system board)	CTRL_DST_PB1 (fPERC input connector)
8	SL1_CPU1_PB2 (signal connector on system board)	CTRL_DST_PA1 (fPERC input connector)
9	SIG_PWR_1 (system board power connector)	BP_PWR_1 (backplane power connector)
10	CTRL_SRC_SA1 (fPERC controller connector)	BP_DST_SA1 (backplane signal connector)
11	CTRL_SRC_SB1 (fPERC controller connector)	BP_DST_SA1 (backplane signal connector)

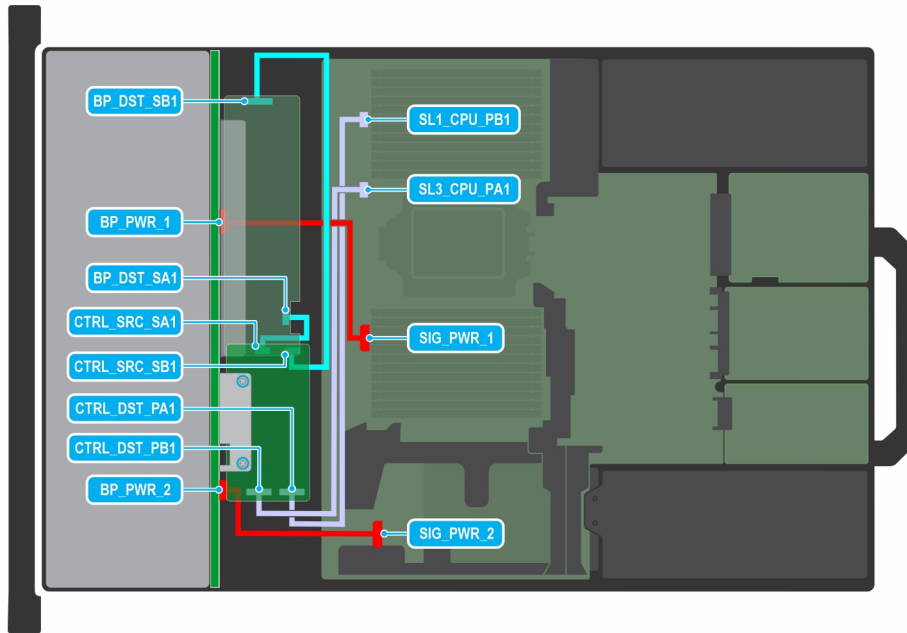


**Figure 87. 24 x 2.5 inch SAS/SATA with FPERC11**

**NOTE:** Follow the sequential order as shown in the table to remove the cables, to install the cables follow the reverse sequential order.

**Table 82. 24 x 2.5 inch SAS/SATA with FPERC11**

Order	From	To
1	SIG_PWR_2 (system board power connector)	BP_PWR_2 (backplane power connector)
2	SL1_CPU1_PA4 (signal connector on system board)	CTRL_DST_PA1 (fPERC input connector)
3	SIG_PWR_1 (system board power connector)	BP_PWR_1 (backplane power connector)
4	CTRL_SRC_SB1 (fPERC controller connector)	BP_DST_SB1 (backplane signal connector)
5	CTRL_SRC_SA1 (fPERC controller connector)	BP_DST_SA1 (backplane signal connector)

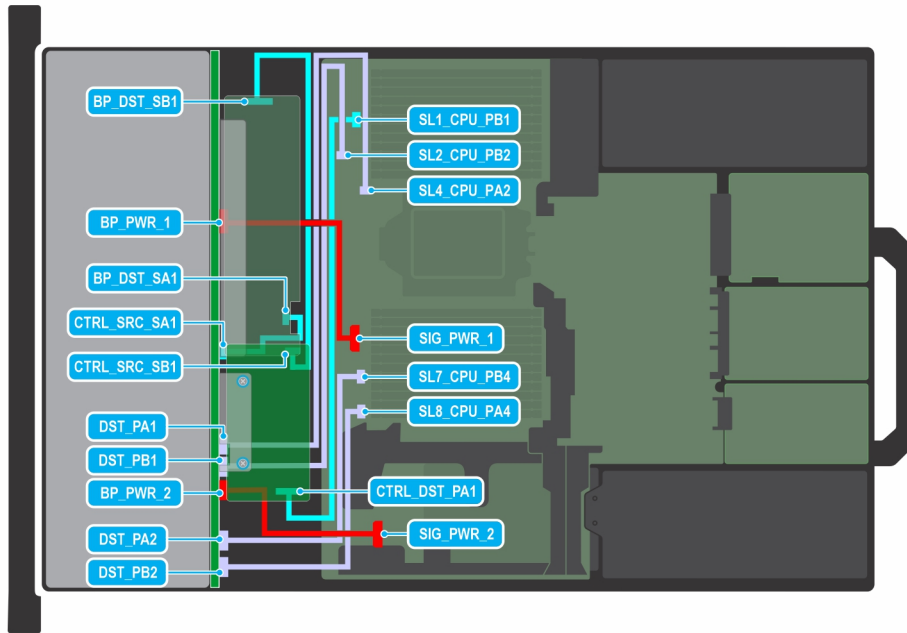


**Figure 88. 24 x 2.5 inch SAS/SATA with FPERC12**

**NOTE:** Follow the sequential order as shown in the table to remove the cables, to install the cables follow the reverse sequential order.

**Table 83. 24 x 2.5 inch SAS/SATA with FPERC12**

Order	From	To
1	SIG_PWR_2 (system board power connector)	BP_PWR_2 (backplane power connector)
2	SL1_CPU1_PB2 (signal connector on system board)	CTRL_DST_PA1 (fPERC input connector)
3	SL3_CPU1_PB2 (signal connector on system board)	CTRL_DST_PB1 (fPERC input connector)
4	BP_DST_SB1 (backplane signal connector)	CTRL_SRC_SB1 (fPERC controller connector)
5	BP_DST_SA1 (backplane signal connector)	CTRL_SRC_SA1 (fPERC controller connector)
6	SIG_PWR_1 (system board power connector)	BP_PWR_1 (backplane power connector)



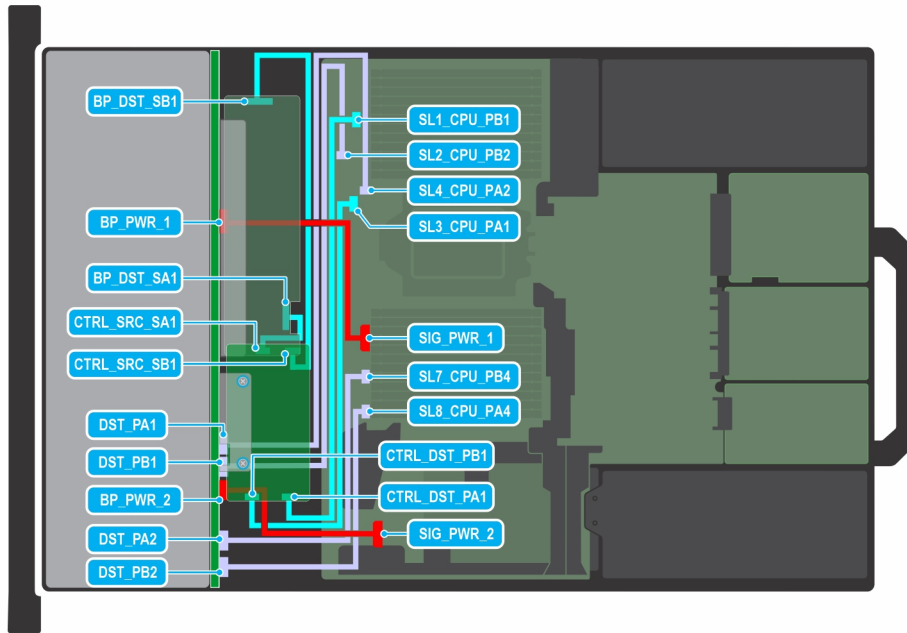
**Figure 89. 24 x 2.5 inch SAS/SATA with 8 Universal drives with FPERC11**

**NOTE:** Follow the sequential order as shown in the table to remove the cables, to install the cables follow the reverse sequential order.

**Table 84. 24 x 2.5 inch SAS/SATA with 8 Universal drives with FPERC11**

Order	From	To
1	SL7_CPU1_PB4 (signal connector on system board)	DST_PA2 (backplane signal connector)
2	SL8_CPU1_PA4 (signal connector on system board)	DST_PB2 (backplane signal connector)
3	SIG_PWR_2 (system board power connector)	BP_PWR_2 (backplane power connector)
4	SL1_CPU1_PB2 (signal connector on system board)	CTRL_DST_PA1 (fPERC input connector)
5	SL2_CPU1_PB2 (signal connector on system board)	DST_PA1 (backplane signal connector)
6	SL4_CPU1_PB2 (signal connector on system board)	DST_PB1 (backplane signal connector)
7	CTRL_SRC_SB1 (fPERC controller connector)	BP_DST_SB1 (backplane signal connector)
8	CTRL_SRC_SA1 (fPERC controller connector)	BP_DST_SA1 (backplane signal connector)
9	SIG_PWR_1 (system board power connector)	BP_PWR_1 (backplane power connector)



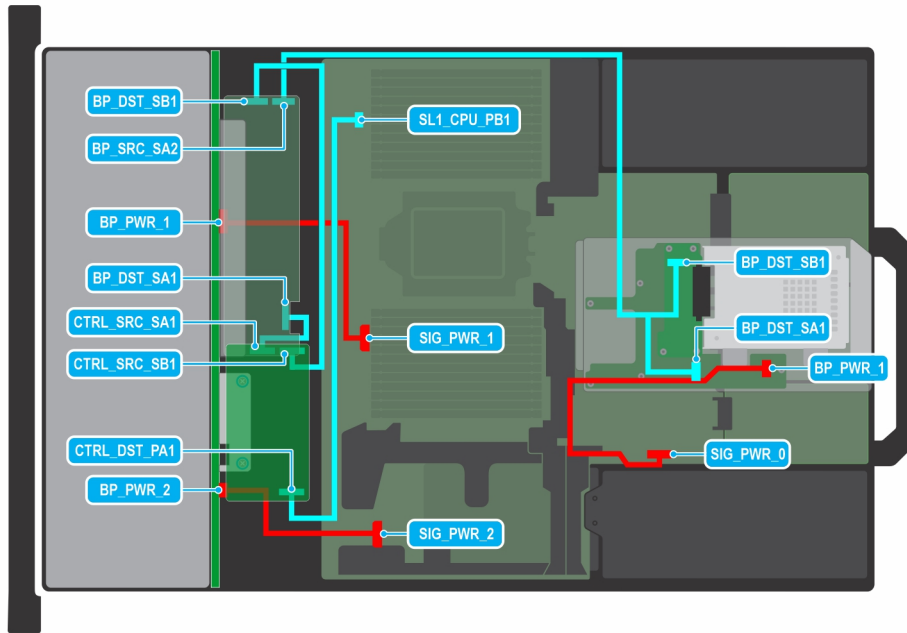


**Figure 90. 24 x 2.5 inch SAS/SATA with 8 x Universal drives with FPERC12**

**NOTE:** Follow the sequential order as shown in the table to remove the cables, to install the cables follow the reverse sequential order.

**Table 85. 24 x 2.5 inch SAS/SATA with 8 x Universal drives with FPERC12**

Order	From	To
1	SL7_CPU1_PB4 (signal connector on system board)	DST_PA2 (backplane signal connector)
2	SL8_CPU1_PA4 (signal connector on system board)	DST_PB2 (backplane signal connector)
3	CTRL_DST_PB1 (fPERC input connector)	SL3_CPU1_PB2 (signal connector on system board)
4	CTRL_DST_PA1 (fPERC input connector)	SL1_CPU1_PB2 (signal connector on system board)
5	SIG_PWR_2 (system board power connector)	BP_PWR_2 (backplane power connector)
6	SL2_CPU1_PB2 (signal connector on system board)	DST_PB1 (backplane signal connector)
7	SL4_CPU1_PB2 (signal connector on system board)	DST_PA1 (backplane signal connector)
8	CTRL_SRC_SA1 (fPERC controller connector)	BP_DST_SA2 (backplane signal connector)
9	CTRL_SRC_SB1 (fPERC controller connector)	BP_DST_SB1 (backplane signal connector)
10	SIG_PWR_1 (system board power connector)	BP_PWR_1 (backplane power connector)

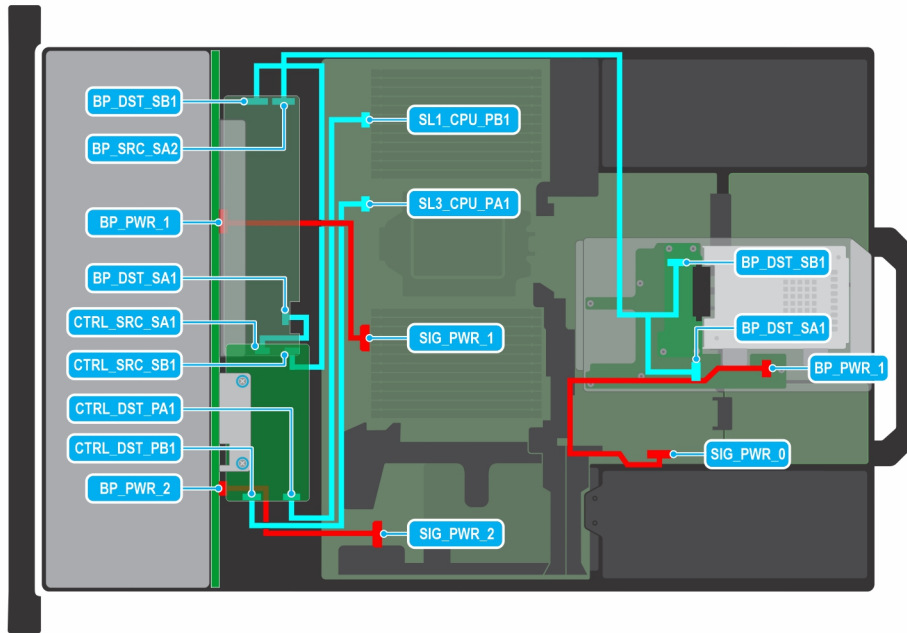


**Figure 91. 24 x 2.5 inch SAS/SATA drives with 2 x 2.5 inch SAS/SATA drives with FPERC11**

**NOTE:** Follow the sequential order as shown in the table to remove the cables, to install the cables follow the reverse sequential order.

**Table 86. 24 x 2.5 inch SAS/SATA drives with 2 x 2.5 inch SAS/SATA drives with FPERC11**

Order	From	To
1	SIG_PWR_1 (system board power connector)	BP_PWR_1 (backplane power connector)
2	SIG _PWR_2 (system board power connector)	BP_PWR_2 (backplane power connector)
3	SIG_PWR_0 (system board power connector)	BP_PWR_1 (backplane power connector)
4	SL1_CPU1_PB2 (signal connector on system board)	CTRL_DST_PA1 (fPERC input connector)
5	CTRL_SRC_SB1 (fPERC controller connector)	BP_DST_SB1 (backplane signal connector)
6	BP_DST_SA1 and BP_DST_SB1 (backplane signal connector)	BP_SRC_SA2 (backplane controller connector)
7	CTRL_SRC_SA1 (fPERC controller connector)	BP_DST_SA1 (backplane signal connector)

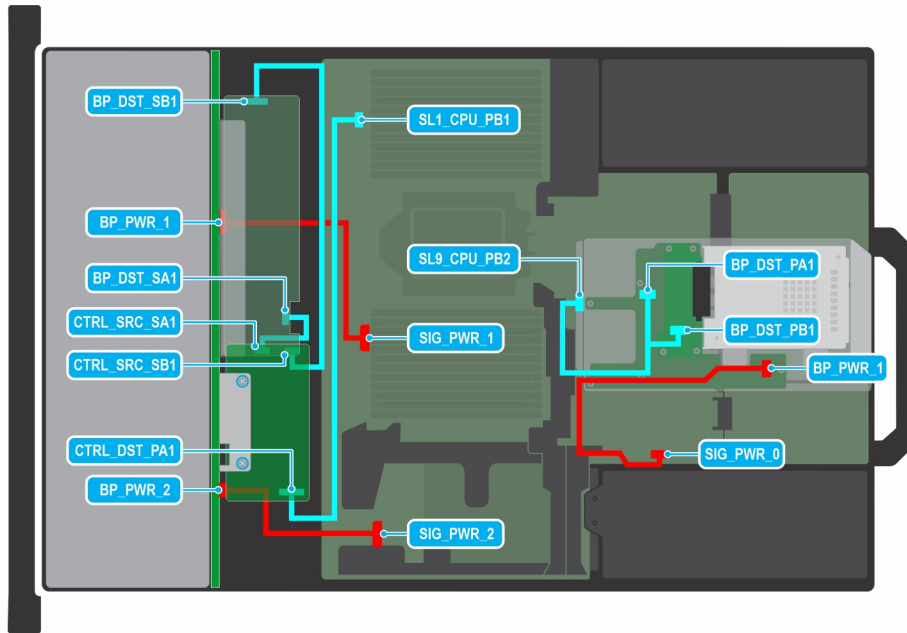


**Figure 92. 24 x 2.5 inch SAS/SATA drives with 2 x 2.5 inch SAS/SATA drives with FPERC12**

**NOTE:** Follow the sequential order as shown in the table to remove the cables, to install the cables follow the reverse sequential order.

**Table 87. 24 x 2.5 inch SAS/SATA drives with 2 x 2.5 inch SAS/SATA drives with FPERC12**

Order	From	To
1	SIG_PWR_1 (system board power connector)	BP_PWR_1 (backplane power connector)
2	SIG _PWR_2 (system board power connector)	BP_PWR_2 (backplane power connector)
3	SIG_PWR_0 (system board power connector)	BP_PWR_1 (backplane power connector)
4	SL1_CPU1_PB2 (signal connector on system board)	CTRL_DST_PA1 (fPERC input connector)
5	SL3_CPU1_PB2 (signal connector on system board)	CTRL_DST_PB1 (fPERC input connector)
6	CTRL_SRC_SB1 (fPERC controller connector)	BP_DST_SB1 (backplane signal connector)
7	BP_DST_SA1 and BP_DST_SB1 (backplane signal connector)	BP_SRC_SA2 (backplane controller connector)
8	CTRL_SRC_SA1 (fPERC controller connector)	BP_DST_SA1 (backplane signal connector)

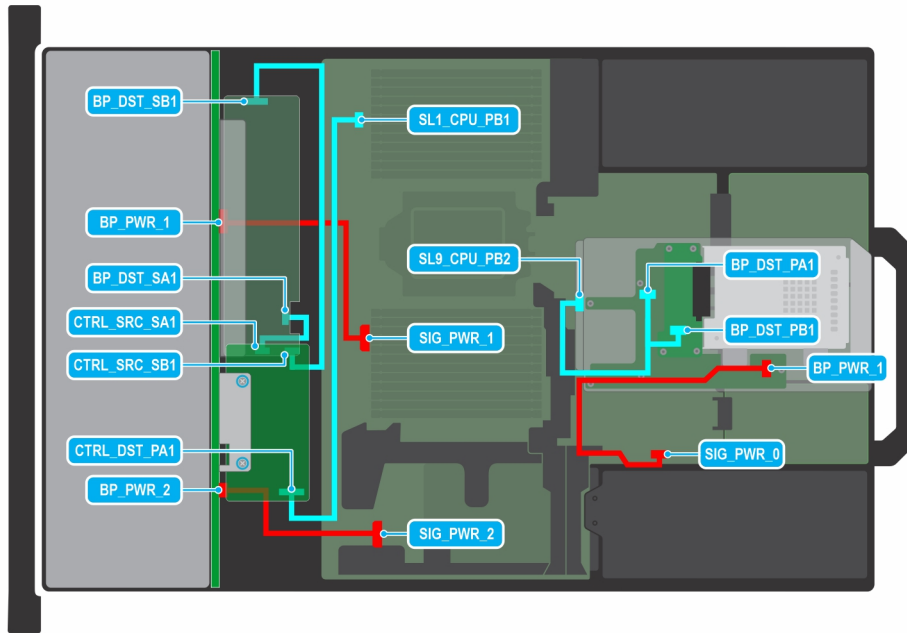


**Figure 93. 24 x 2.5 inch SAS/SATA drives with 2 x Universal drives with FPERC11**

**NOTE:** Follow the sequential order as shown in the table to remove the cables, to install the cables follow the reverse sequential order.

**Table 88. 24 x 2.5 inch SAS/SATA drives with 2 x Universal drives with FPERC11**

Order	From	To
1	SIG_PWR_1 (system board power connector)	BP_PWR_1 (backplane power connector)
2	SIG_PWR_2 (system board power connector)	BP_PWR_2 (backplane power connector)
3	SL1_CPU1_PB2 (signal connector on system board)	CTRL_DST_PA1 (fPERC input connector)
4	CTRL_SRC_SB1 (fPERC controller connector)	BP_DST_SB1 (backplane signal connector)
5	CTRL_SRC_SA1 (fPERC controller connector)	BP_DST_SA1 (backplane signal connector)
6	SIG_PWR_0 (system board power connector)	BP_PWR_1 (backplane power connector)
7	SL9_CPU1_PB2 (signal connector on system board)	BP_DST_PA1 and BP_DST_PB1 (backplane signal connector)

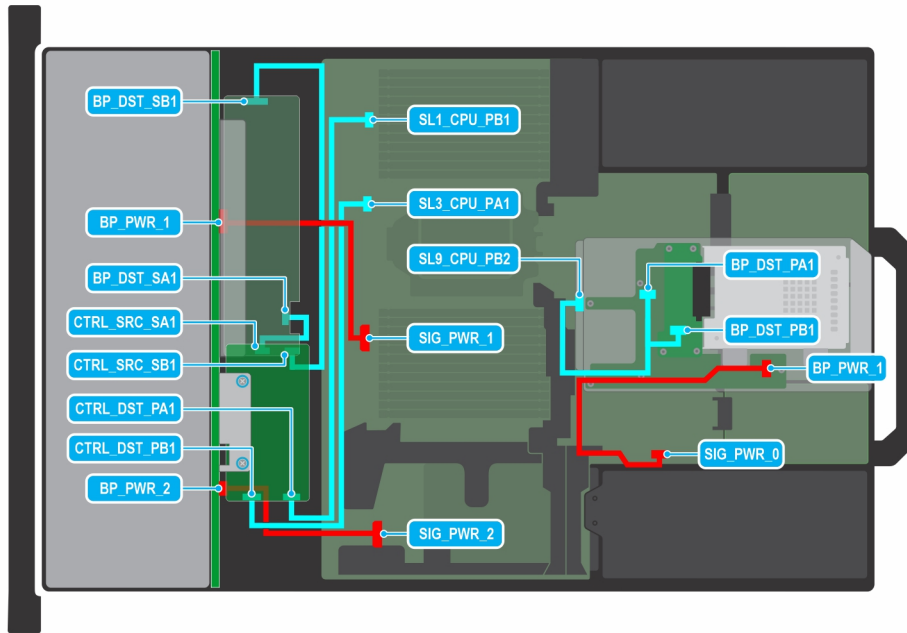


**Figure 94. 24 x 2.5 inch SAS/SATA drives with 2 x Universal drives with FPERC12**

**NOTE:** Follow the sequential order as shown in the table to remove the cables, to install the cables follow the reverse sequential order.

**Table 89. 24 x 2.5 inch SAS/SATA drives with 2 x Universal drives with FPERC12**

Order	From	To
1	SIG_PWR_1 (system board power connector)	BP_PWR_1 (backplane power connector)
2	SIG_PWR_2 (system board power connector)	BP_PWR_2 (backplane power connector)
3	SL1_CPU1_PB2 (signal connector on system board)	CTRL_DST_PA1 (fPERC input connector)
4	CTRL_SRC_SB1 (fPERC controller connector)	BP_DST_SB1 (backplane signal connector)
5	CTRL_SRC_SA1 (fPERC controller connector)	BP_DST_SA1 (backplane signal connector)
6	SIG_PWR_0 (system board power connector)	BP_PWR_1 (backplane power connector)
7	SL9_CPU1_PB2 (signal connector on system board)	BP_DST_PA1 and BP_DST_PB1 (backplane signal connector)

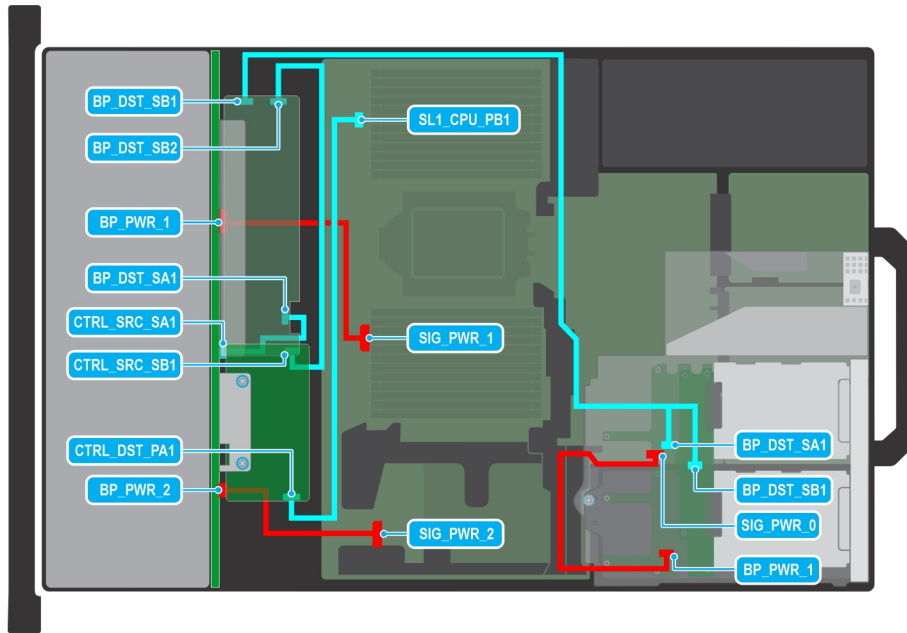


**Figure 95. 24 x 2.5 inch SAS/SATA drives with 4 x 2.5 inch drives with FPERC11.**

**NOTE:** Follow the sequential order as shown in the table to remove the cables, to install the cables follow the reverse sequential order.

**Table 90. 24 x 2.5 inch SAS/SATA drives with 4 x 2.5 inch drives with FPERC11**

Order	From	To
1	SIG_PWR_2 (system board power connector)	BP_PWR_2 (backplane power connector)
2	SL1_CPU1_PB2 (signal connector on system board)	CTRL_DST_PA1 (fPERC input connector)
3	SL3_CPU1_PB2 (signal connector on system board)	CTRL_DST_PB1 (fPERC input connector)
4	CTRL_SRC_SB1 (fPERC controller connector)	BP_DST_SB1 (backplane signal connector)
5	CTRL_SRC_SA1 (fPERC controller connector)	BP_DST_SA1 (backplane signal connector)
6	SL9_CPU1_PB2 (signal connector on system board)	BP_DST_PA1 and BP_DST_PB1 (backplane signal connector)
7	SIG_PWR_1 (system board power connector)	BP_PWR_1 (backplane power connector)
8	SIG_PWR_0 (system board power connector)	BP_PWR_1 (backplane power connector)

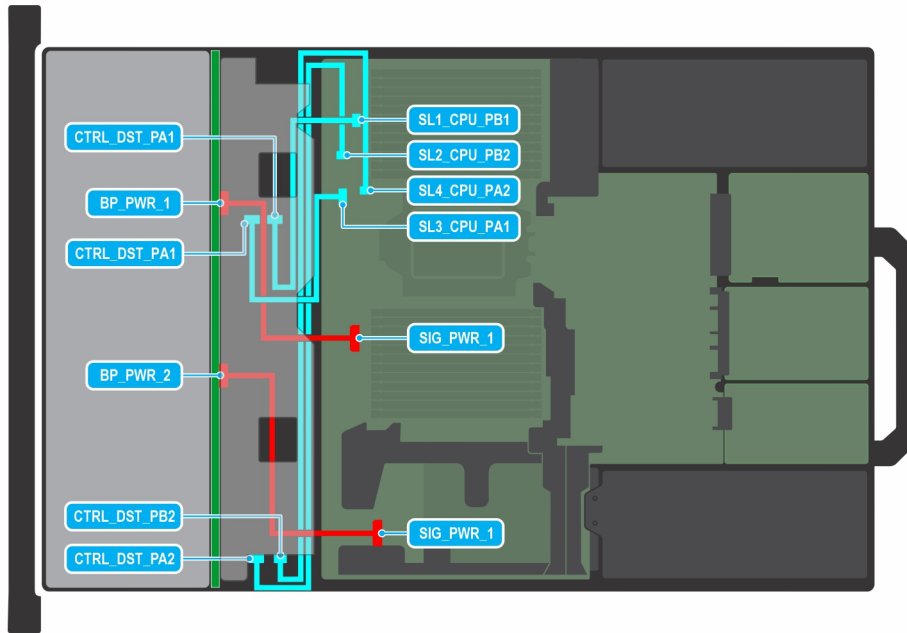


**Figure 96. 24 x 2.5 inch SAS/SATA drives with 4 x 2.5 inch drives with FPERC12.**

**NOTE:** Follow the sequential order as shown in the table to remove the cables, to install the cables follow the reverse sequential order.

**Table 91. 24 x 2.5 inch SAS/SATA drives with 4 x 2.5 inch drives with FPERC12**

Order	From	To
1	SIG_PWR_1 (system board power connector)	BP_PWR_1 (backplane power connector)
2	SL1_CPU1_PB2 (signal connector on system board)	CTRL_DST_PA1 (fPERC input connector)
3	CTRL_SRC_SB1 (fPERC controller connector)	BP_DST_SB1 (backplane signal connector)
4	BP_SRC_SA2 (fPERC backplane connector)	BP_DST_SA1 and BP_DST_SB1 (backplane signal connector)
5	CTRL_SRC_SA1 (fPERC controller connector)	BP_DST_SA1 (backplane signal connector)
6	SIG_PWR_2 (system board power connector)	BP_PWR_2 (backplane power connector)
7	SIG_PWR_0 (system board power connector)	BP_PWR_1 (backplane power connector)



**Figure 97. 24 x 2.5 inch U.2 drives Gen5 Single Width**

**NOTE:** Follow the sequential order as shown in the table to remove the cables, to install the cables follow the reverse sequential order.

**Table 92. 24 x 2.5 inch U.2 drives Gen5 Single Width**

Order	From	To
1	SL4_CPU1_PB2 (signal connector on system board)	CTRL_DST_PB2 (fPERC input connector)
2	SL2_CPU1_PB2 (signal connector on system board)	CTRL_DST_PA2 (fPERC input connector)
3	SIG_PWR_1 (system board power connector)	BP_PWR_2 (backplane power connector)
4	SL3_CPU1_PB2 (signal connector on system board)	CTRL_DST_PA1 (fPERC input connector)
5	SL1_CPU1_PB2 (signal connector on system board)	CTRL_DST_PA1 (fPERC input connector)
6	SIG_PWR_1 (system board power connector)	BP_PWR_1 (backplane power connector)

## PERC module

This is a service technician replaceable part only.

### Removing the rear mounting front PERC module

#### Prerequisites

1. Follow the safety guidelines listed in the [Safety instructions](#).
2. Follow the procedure listed in the [Before working inside your system](#).
3. [Remove the cooling fan cage assembly](#).

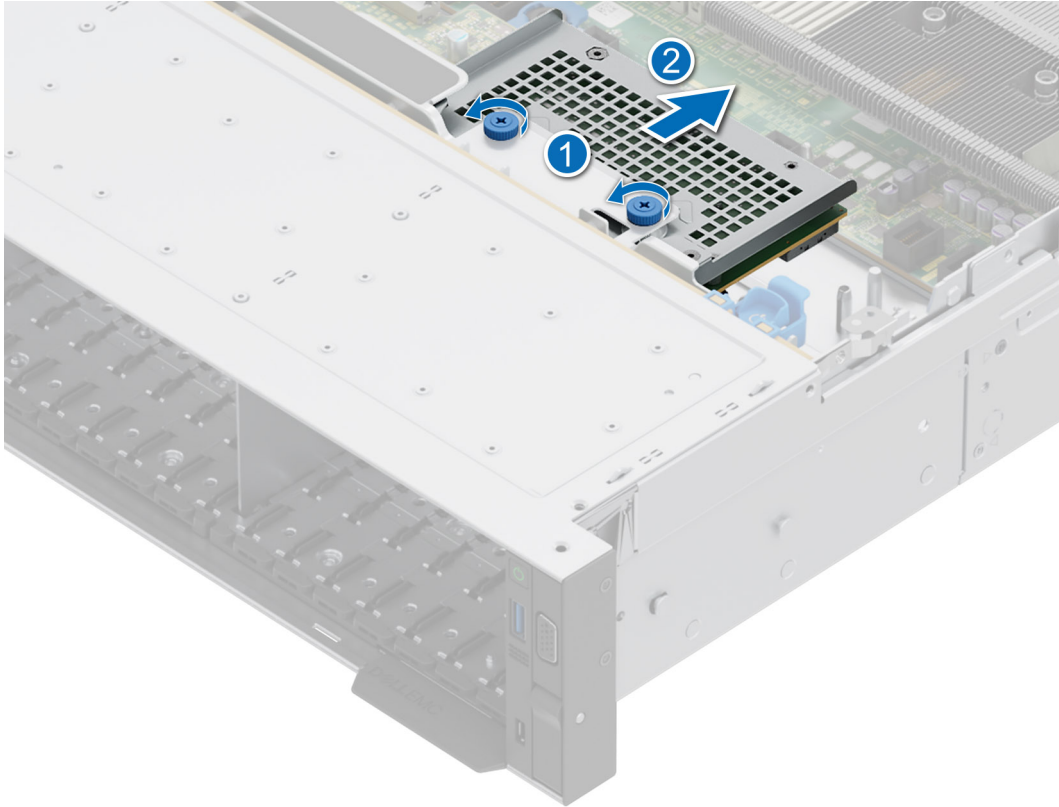


4. Remove the drive backplane cover.
5. If required, remove the air shroud or remove the GPU air shroud..
6. If required, remove the drive backplane cover.
7. Disconnect all the cables, observe the cable routing.

**NOTE:** Refer [Cable routing](#) topic for more information.

### Steps

1. Using a Phillips #2 screwdriver, loosen the captive screws on the rear mounting front PERC module.
2. Slide the rear mounting front PERC module to disengage from the connector on the drive backplane.



**Figure 98. Removing the rear mounting front PERC module**

### Next steps

1. [Replace the rear mounting front PERC module.](#)

## Installing the rear mounting front PERC module

### Prerequisites

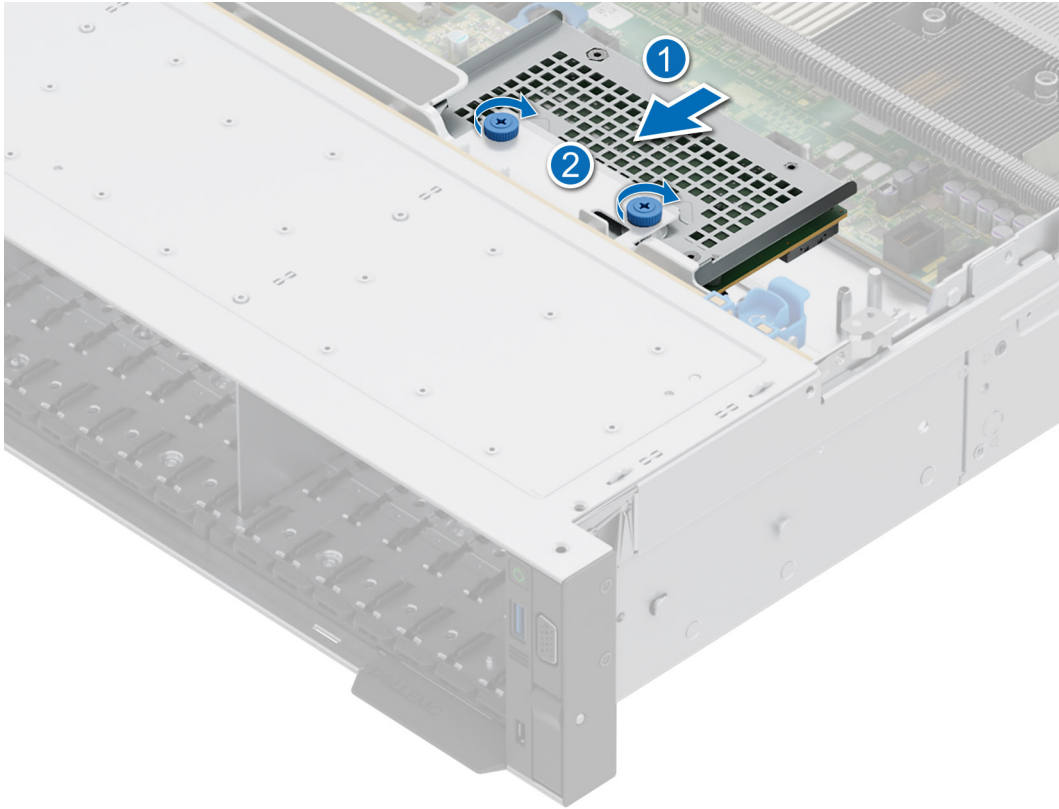
1. Follow the safety guidelines listed in the [Safety instructions](#).
2. Follow the procedure listed in [Before working inside your system](#).
3. [Remove the cooling fan cage assembly](#).
4. [Remove the drive backplane cover](#).
5. If required, [remove the air shroud](#) or [remove the GPU air shroud](#).
6. Route the cable properly to prevent the cable from being pinched or crimped.

**NOTE:** Refer [Cable routing](#) topic for more information.

## Steps

1. Align the connectors and guide slots on the rear mounting front PERC module with the connectors and guide pins on the drive backplane.
2. Slide the rear mounting front PERC module until the module is connected to the drive backplane.
3. Using a Phillips #2 screwdriver, tighten the captive screws on the rear mounting front PERC module.

**NOTE:** The numbers on the image do not depict the exact steps. The numbers are for representation of sequence.



**Figure 99. Installing the rear mounting front PERC module**

## Next steps

1. Connect all the cables, observe the cable routing.
2. [Install the cooling fan cage assembly.](#)
3. If removed, [install the air shroud](#) or [install the GPU air shroud.](#)
4. [Install the drive backplane cover.](#)
5. Follow the procedure listed in [After working inside your system.](#)

## Removing the front mounting front PERC module

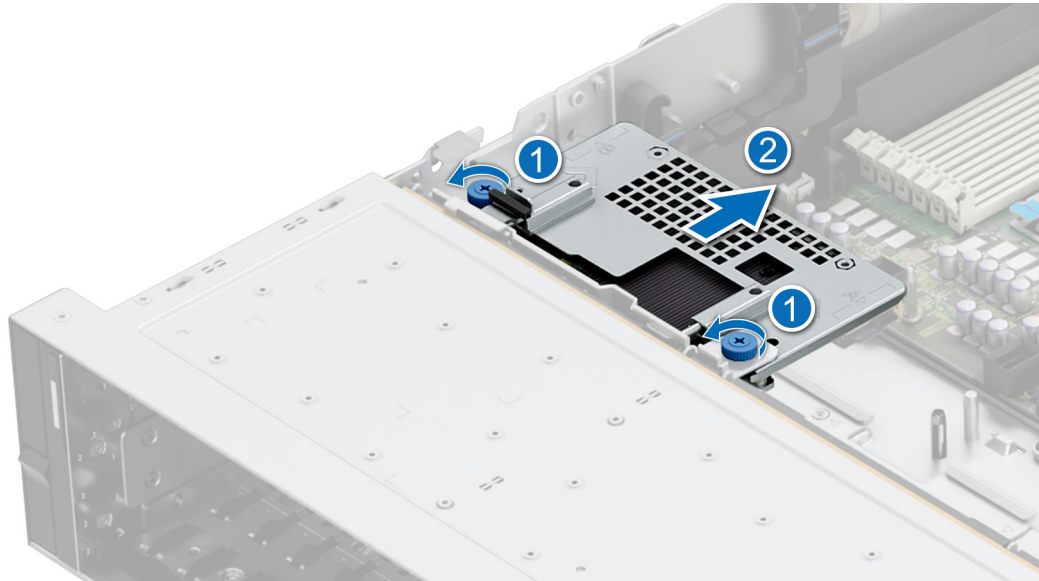
### Prerequisites

1. Follow the safety guidelines listed in the [Safety instructions.](#)
2. Follow the procedure listed in the [Before working inside your system.](#)
3. [Remove the cooling fan cage assembly.](#)
4. [Remove the drive backplane cover.](#)
5. If required, [remove the air shroud](#) or [remove the GPU air shroud..](#)
6. If required, [remove the drive backplane cover.](#)
7. Disconnect all the cables, observe the cable routing.

**NOTE:** Refer [Cable routing](#) topic for more information.

### Steps

1. Using a Phillips #2 screwdriver, loosen the captive screws on the front mounting front PERC module.
2. Slide the front mounting front PERC module to disengage from the connector on the drive backplane.



**Figure 100. Removing the front mounting front PERC module**

### Next steps

1. [Replace the front mounting front PERC module.](#)

## Installing the front mounting front PERC module

### Prerequisites

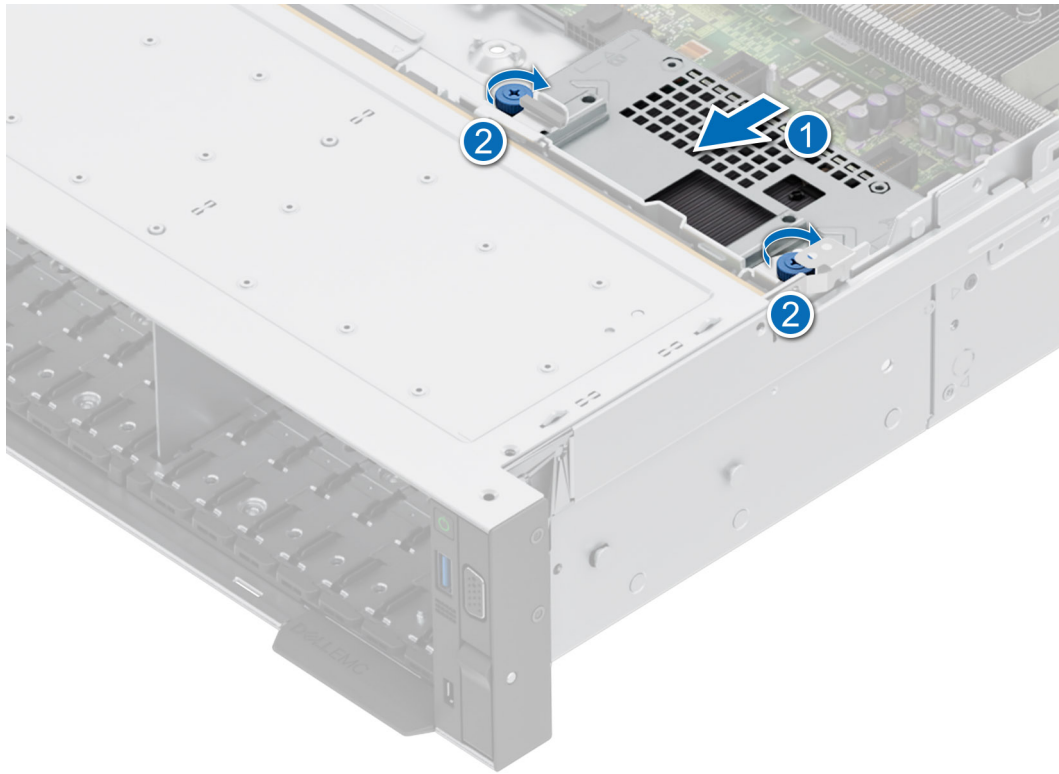
1. Follow the safety guidelines listed in the [Safety instructions](#).
2. Follow the procedure listed in [Before working inside your system](#).
3. [Remove the cooling fan cage assembly](#).
4. [Remove the drive backplane cover](#).
5. If required, [remove the air shroud](#) or [remove the GPU air shroud](#).
6. If required, [remove the drive backplane cover](#).
7. Route the cable properly to prevent the cable from being pinched or crimped.

**i** **NOTE:** Refer [Cable routing](#) topic for more information.

### Steps

1. Align the connectors and guide slots on the front mounting front PERC module with the connectors and guide pins on the drive backplane.
2. Slide the front mounting front PERC module until the module is connected to the drive backplane.
3. Using a Phillips #2 screwdriver, tighten the captive screws on the front mounting front PERC module.

**i** **NOTE:** The numbers on the image do not depict the exact steps. The numbers are for representation of sequence.



**Figure 101. Installing the front mounting front PERC module**

### Next steps

1. Connect all the cables, observe the cable routing.
2. [Install the cooling fan cage assembly.](#)
3. If removed, [install the air shroud](#) or [install the GPU air shroud.](#)
4. [Install the drive backplane cover.](#)
5. Follow the procedure listed in [After working inside your system.](#)

## Removing the adapter PERC module

### Prerequisites

1. Follow the safety guidelines listed in the [Safety instructions.](#)
2. Follow the procedure listed in the [Before working inside your system.](#)
3. If required, [remove the air shroud](#) or [remove the GPU air shroud.](#)
4. If required, [remove the drive backplane cover.](#)
5. [Remove the cooling fan cage assembly.](#)
6. [Remove the expansion card riser.](#)
7. Disconnect all the cables from the Adapter PERC card, observe the cable routing.

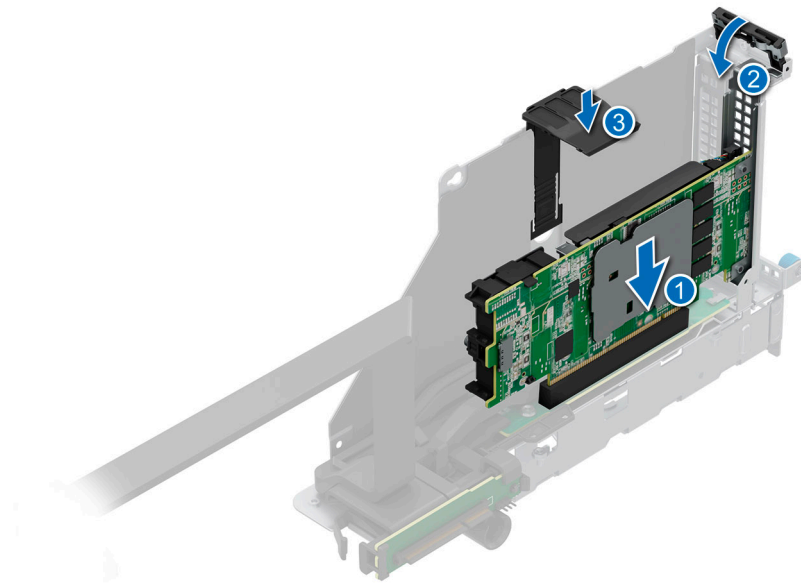
**i** **NOTE:** Refer [Cable routing](#) topic for more information.

**i** **NOTE:** Adapter PERC module must be installed only in expansion card riser 1 or riser 2.

### Steps

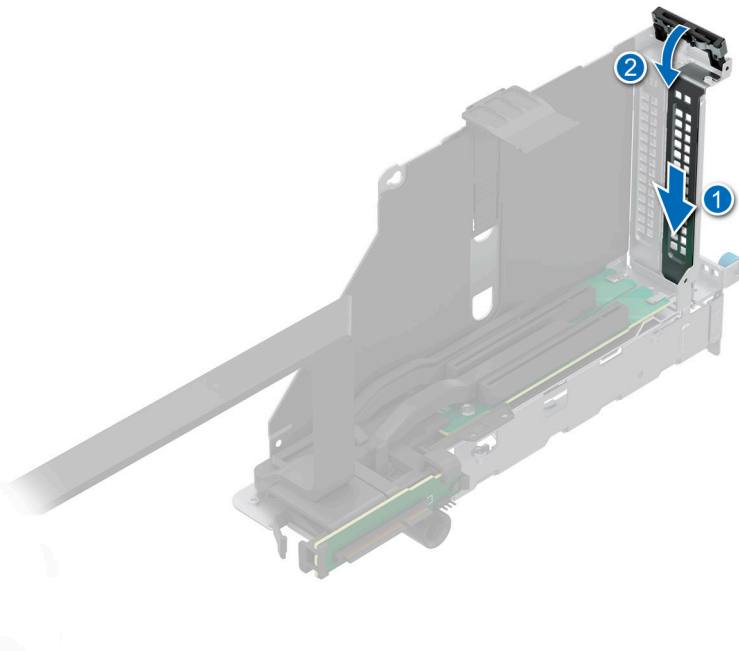
1. Tilt the expansion card retention latch lock to open.
2. Pull the card holder before removing the card from the riser.
3. Hold the Adapter PERC module by the edges, and pull the module from the expansion card connector on the riser.

**i** **NOTE:** The numbers on the image do not depict the exact steps. The numbers are for representation of sequence.



**Figure 102. Removing the Adapter PERC module**

4. If the Adapter PERC module is not going to be replaced, install a filler bracket and close the card retention latch.



**Figure 103. Installing the filler bracket**

**Next steps**

1. Replace the Adapter PERC module.

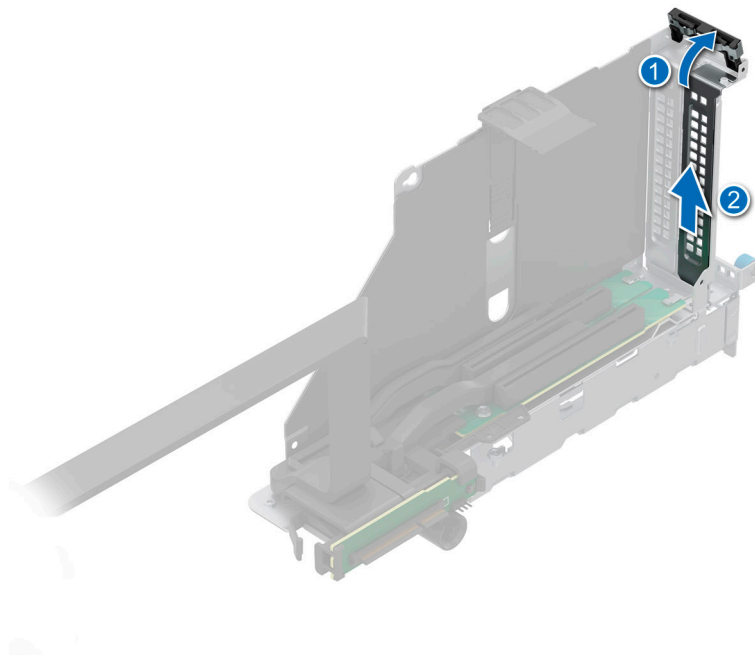
# Installing the adapter PERC module

## Prerequisites

1. Follow the safety guidelines listed in the [Safety instructions](#).
2. Follow the procedure listed in [Before working inside your system](#).
3. If required, [remove the air shroud](#) or [remove the GPU air shroud](#).
4. If required, [remove the drive backplane cover](#).
5. [Remove the cooling fan cage assembly](#).
6. [Remove the expansion card riser](#).
7. Disconnect all the cables from the adapter PERC card, observe the cable routing.  
**i** **NOTE:** Refer [Cable routing](#) topic for more information.
8. If a new APERC module has to be installed, unpack it and prepare the module for installation.  
**i** **NOTE:** For instructions, see the documentation accompanying the card.  
**i** **NOTE:** APERC module must be installed only in expansion card riser 1 or riser 2.

## Steps

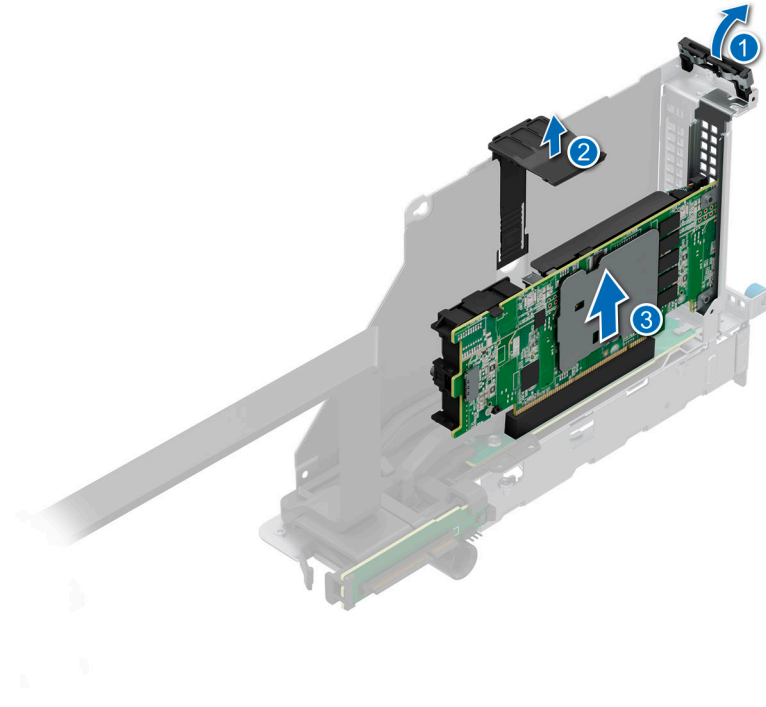
1. Pull and lift up the expansion card retention latch lock to open.
2. If installed, remove the filler bracket.  
**i** **NOTE:** Store the filler bracket for future use. Filler brackets must be installed in empty expansion card slots to maintain Federal Communications Commission (FCC) certification of the system. The brackets also keep dust and dirt out of the system and aid in proper cooling and airflow inside the system.



**Figure 104. Removing the filler bracket**

3. Hold the Adapter PERC module by the edges, and align the module edge connector with the expansion card connector on the riser.
4. Insert the module into the expansion card connector until firmly seated.
5. Close the expansion card retention latch.
6. Push the card holder to hold the module in the riser.

**NOTE:** The numbers on the image do not depict the exact steps. The numbers are for representation of sequence.



**Figure 105. Installing the Adapter PERC module**

#### Next steps

1. Connect the cables to the Adapter PERC module and route the cables properly.  
**NOTE:** Refer [Cable routing](#) topic for more information.
2. [Install the cooling fan cage assembly.](#)
3. If removed, [install the air shroud](#) or [install the GPU air shroud.](#)
4. [Install the drive backplane cover.](#)
5. [Install the expansion card riser.](#)
6. Follow the procedure listed in [After working inside your system.](#)

## Rear drive cage

### Removing the rear drive cage

#### Prerequisites

1. Follow the safety guidelines listed in the [Safety instructions.](#)
2. Follow the procedure listed in the [Before working inside your system.](#)
3. [Remove the drives.](#)
4. [Remove the air shroud.](#)

#### Steps

1. Using a Phillips #2 screwdriver, loosen the captive screws that secure the rear drive cage to the system.
2. Slide the rear drive cage towards the front of the system to disengage it from the system.
3. Remove the rear drive cage from the system.

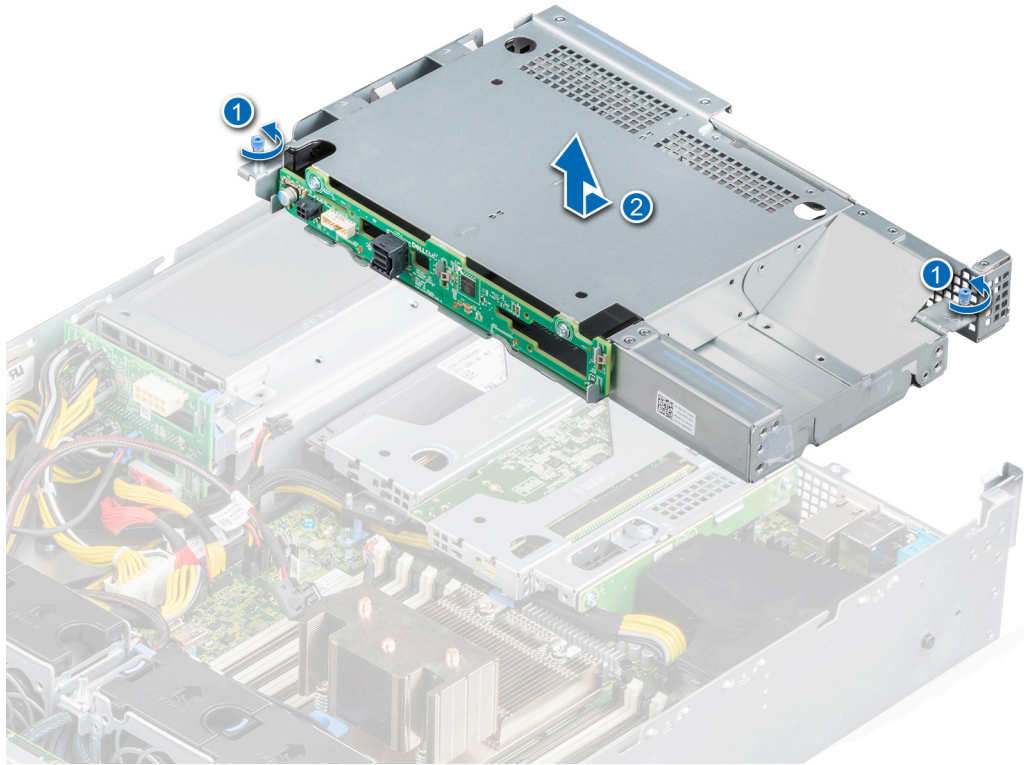


Figure 106. Removing the rear drive cage

#### Next steps

1. [Replace the rear drive cage.](#)

## Installing the rear drive cage

#### Prerequisites

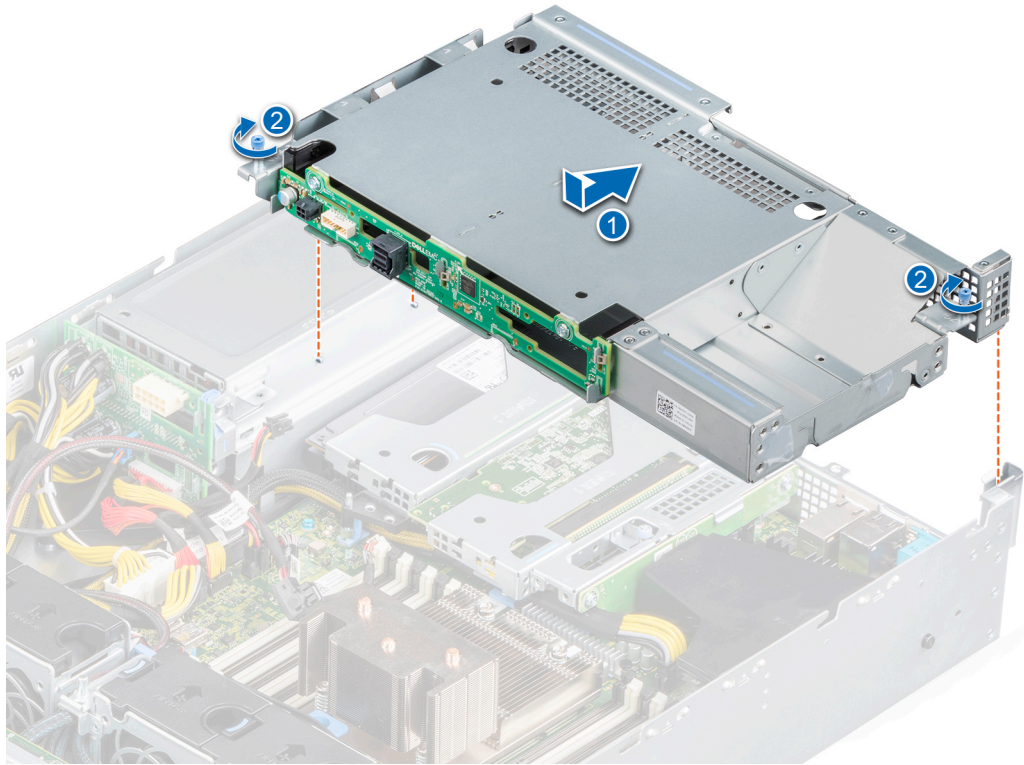
1. Follow the safety guidelines listed in the [Safety instructions](#).
2. Follow the procedure listed in the [Before working inside your system](#).
3. [Remove the drives.](#)

#### Steps

1. Align the rear drive cage with the guide pins on the PSU cage.
2. Lower the rear drive cage and slide it to the rear of the system until it is firmly seated.
3. Using a Phillips #2 screwdriver, tighten the captive screws to secure the rear drive cage to the system.

**NOTE:** Store the filler bracket for future use. Filler brackets must be installed in empty expansion card slots to maintain Federal Communications Commission (FCC) certification of the system. The brackets also keep dust and dirt out of the system and aid in proper cooling and airflow inside the system.





**Figure 107. Installing the rear drive cage**

### Next steps

1. [Install the drives](#) in their original locations.
2. [Install the air shroud](#).
3. Follow the procedure listed in [After working inside your system](#).

## System memory

### System memory guidelines

The PowerEdge R7615 system supports DDR5 registered DIMMs (RDIMMs).

Your system memory is organized into eight channels per processor (two memory sockets per channel), 12 memory sockets per processor.

Memory channels are organized as follows:

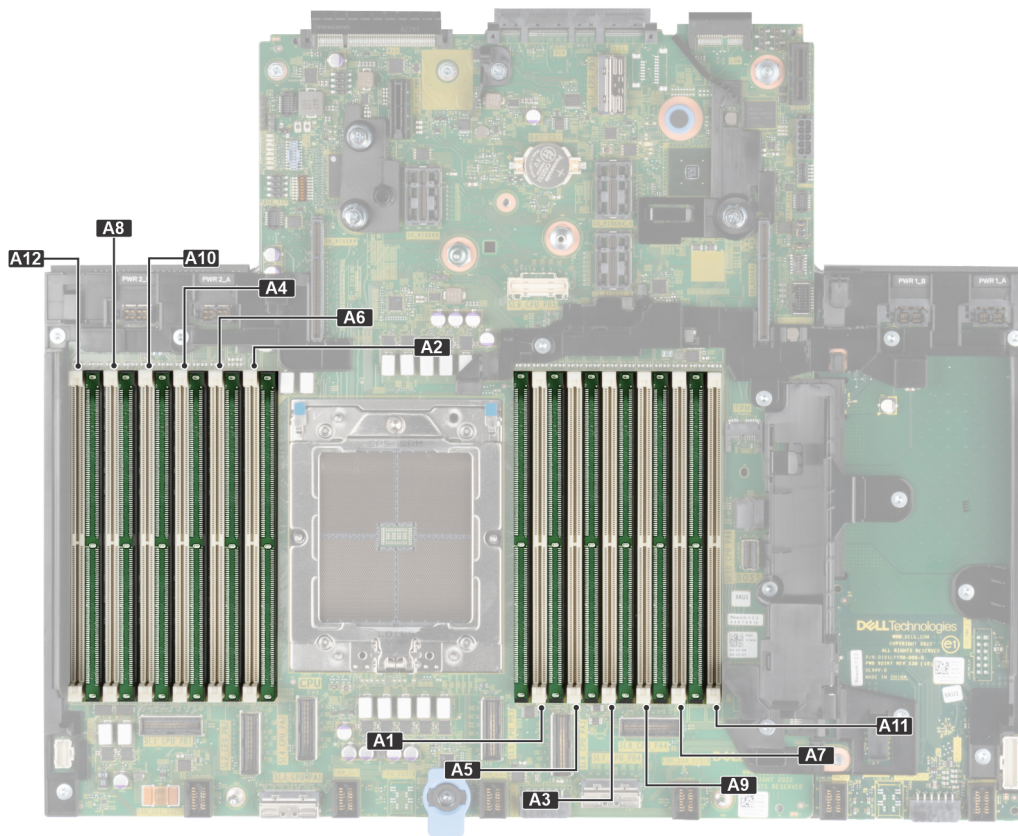


Figure 108. Memory channels

Table 93. Memory channels

Processor	Channel A	Channel B	Channel C	Channel D	Channel E	Channel F	Channel G	Channel H	Channel I	Channel J	Channel K	Channel L
Processor 1	Slots A1	Slots A5	Slots A3	Slots A9	Slots A7	Slots A11	Slots A2	Slots A6	Slots A4	Slots A10	Slots A8	Slots A12

Table 94. Supported memory matrix

DIMM type	Rank	Capacity	DIMM rated voltage and speed	Operating Speed
				1 DIMM per channel (DPC)
DDR5 RDIMM	1 R	16 GB	DDR5 (1.1 V), 4800 MT/s	4800 MT/s
	2 R	32 GB, 64 GB	DDR5 (1.1 V), 4800 MT/s	4800 MT/s
	4 R	128 GB	DDR5 (1.1 V), 4800 MT/s	4800 MT/s
	8 R	256 GB	DDR5 (1.1 V), 4800 MT/s	4800 MT/s

**NOTE:** DDR4 memory is not supported.

**NOTE:** The processor may reduce the performance of the rated DIMM speed.

# General memory module installation guidelines

To ensure optimal performance of your system, observe the following general guidelines when configuring your system memory. If your system's memory configurations fail to observe these guidelines, your system might not boot, stop responding during memory configuration, or operate with reduced memory. This section provides information on the memory population rules for single or dual processor system.

The memory bus operate at speeds up to 4800 MT/s depending on the following factors:

- System profile selected (for example, Performance Optimized, or Custom [can be run at high speed or lower])
- Maximum supported DIMM speed of the processors
- Maximum supported speed of the DIMMs

**NOTE:** MT/s indicates DIMM speed in MegaTransfers per second.

The following are the recommended guidelines for installing memory modules:

- All DIMMs must be DDR5.
- Mixing different DIMM capacities is not supported.
- Mixing module types within a memory channel is not supported. All DIMMs populated must be RDIMM.
- If memory modules with different speeds are installed, they operate at the speed of the slowest installed memory module(s).
- Mixing different widths (x4 & x8) is not supported.
- Populate memory module sockets only if a processor is installed.
  - For single-processor systems, sockets A1 to A12 are available.
  - In Optimizer Mode, the DRAM controllers operate independently in the 64-bit mode and provide optimized memory performance.

**Table 95. Memory population rules**

Processor	Memory population	Memory population information
Single processor	A{1}, A{2}, A{3}, A{4}, A{5}, A{6}, A{7}, A{8}, A{9}, A{10}, A{11}, A{12}	Odd amount of DIMMs per processor allowed.

- Populate all the sockets with white release tabs first, followed by the black release tabs.
- Persistent memory will not be supported on Genoa based platforms.
- For best performance, populate all memory channels equally using identical DIMMs.
- Unbalanced or odd memory configuration results in a performance loss and system may not identify the memory modules being installed, so always populate memory channels identically with equal DIMMs for best performance.
- Minimum recommended configuration is to populate four equal memory modules per processor. AMD recommends limiting processors in that system to 32 cores or less.

## Removing a memory module

### Prerequisites

1. Follow the safety guidelines listed in the [Safety instructions](#).
2. Follow the procedure listed in [Before working inside your system](#).
3. [Remove the air shroud](#).

**NOTE:** The memory modules are hot to touch for some time after the system has been powered down. Allow the memory modules to cool before handling them. Handle the memory modules by the card edges and avoid touching the components or metallic contacts on the memory module.

### Steps

1. Locate the appropriate memory module socket.

**CAUTION:** Handle each memory module only by the card edges, ensuring not to touch the middle of the memory module or metallic contacts.

2. To release the memory module from the socket, simultaneously press the ejectors on both ends of the memory module socket.
3. Lift the memory module away from the system.

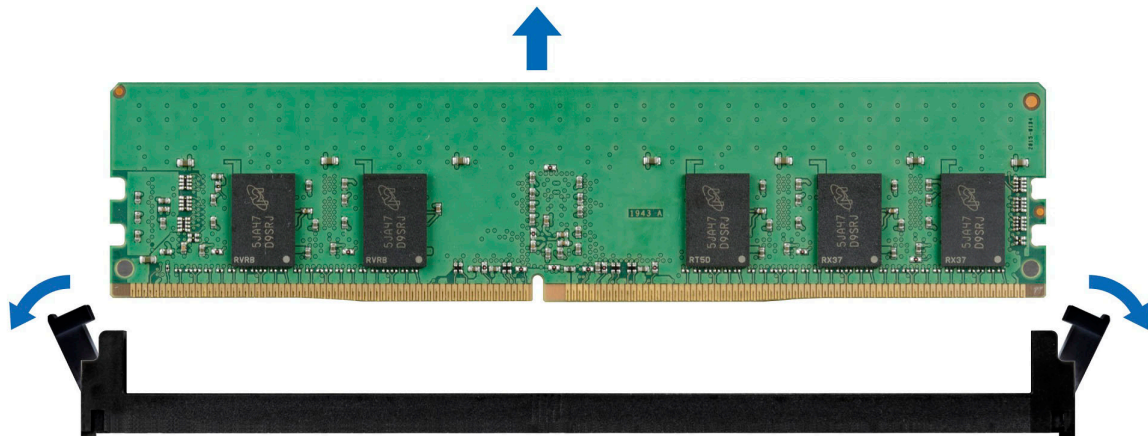


Figure 109. Removing a memory module

### Next steps

1. [Replace the memory module](#). Install a memory module blank, if the memory module is removed permanently.
  - i** **NOTE:** The procedure to install a memory module blank is similar to the procedure to install a memory module.
  - i** **NOTE:** To ensure proper system cooling, memory module blanks must be installed in any memory socket that is not occupied. The memory module blanks compatible with the R7615 are DDR5 gray color blanks. Remove the memory module blanks only if you intend to install memory modules in those sockets.

## Installing a memory module

### Prerequisites

1. Follow the safety guidelines listed in the [Safety instructions](#).
2. Follow the procedure listed in [Before working inside your system](#).
3. [Remove the air shroud](#).

### Steps

1. Locate the appropriate memory module socket.
  - CAUTION:** Handle each memory module only by the card edges, ensuring not to touch the middle of the memory module or metallic contacts.
2. If a memory module is installed in the socket, remove it.
  - i** **NOTE:** Ensure the socket ejector latches are fully open before installing the memory module.
3. Align the edge connector of the memory module with the alignment key of the memory module socket, and insert the memory module in the socket.
  - CAUTION:** To prevent damage to the memory module or the memory module socket during installation, do not bend or flex the memory module; insert both ends of the memory module simultaneously.
  - i** **NOTE:** The memory module socket has an alignment key that enables you to install the memory module in the socket in only one orientation.
  - CAUTION:** Do not apply pressure at the center of the memory module; apply pressure at both ends of the memory module evenly.
4. Press the memory module with your thumbs until the ejectors firmly click into place.

When the memory module is properly seated in the socket, the levers on the memory module socket align with the levers on the other sockets that have memory modules installed.

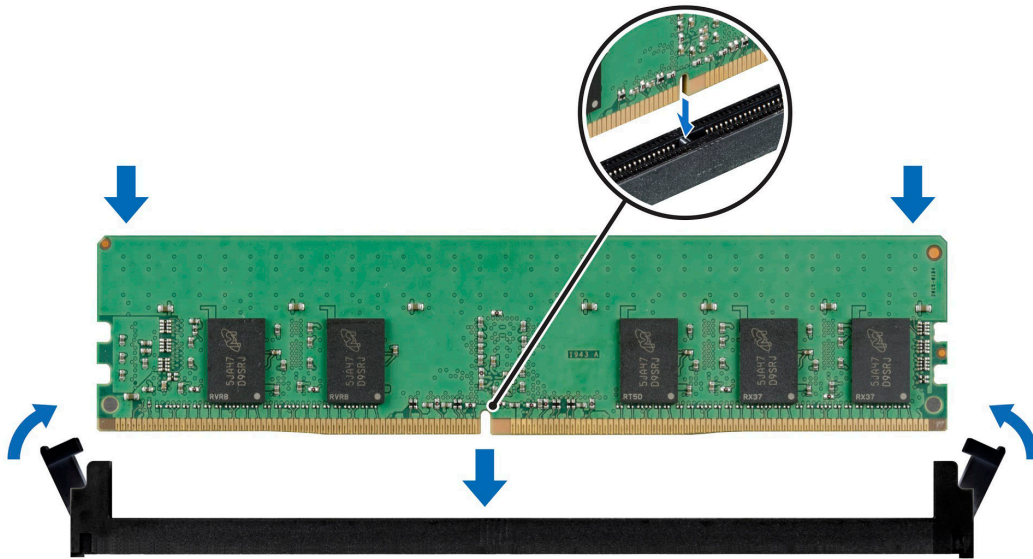


Figure 110. Installing a memory module

#### Next steps

1. [Install the air shroud.](#)
2. Follow the procedure listed in [After working inside your system.](#)
3. To ensure that the memory module has been installed properly, press F2 during reboot to enter the **System Setup**, and check the **System Memory** setting.

The **System Memory Size** indicates the installed memory.

4. If the **System Memory Size** is incorrect, one or more of the memory modules may not be installed properly. . Shut down the system and ensure that the memory modules are firmly seated in the correct sockets.
5. Run the system memory test in the system diagnostics.

## Processor and heat sink

### Removing a heat sink

#### Prerequisites

1. Follow the safety guidelines listed in the [Safety instructions.](#)
2. Follow the procedure listed in the [Before working inside your system.](#)
3. If installed, [remove the air shroud.](#)

**⚠ WARNING:** The heat sink and processor are too hot to touch for some time after the system has been powered off. Allow the heat sink and processor to cool down before handling them.

**i NOTE:** The procedure to uninstall standard and L-type heat sink is similar.

#### Steps

1. Using a Torx #T20 screwdriver, fully loosen the captive screw all the way before moving to the next screw (on one-screw-at-a-time basis).

**i NOTE:** Follow the screw sequence defined on the heat sink label. Disassembly order: 6, 5, 4, 3, 2, 1

**NOTE:** The captive screw numbers are marked on the heat sink.

2. Lift the heat sink from the system.

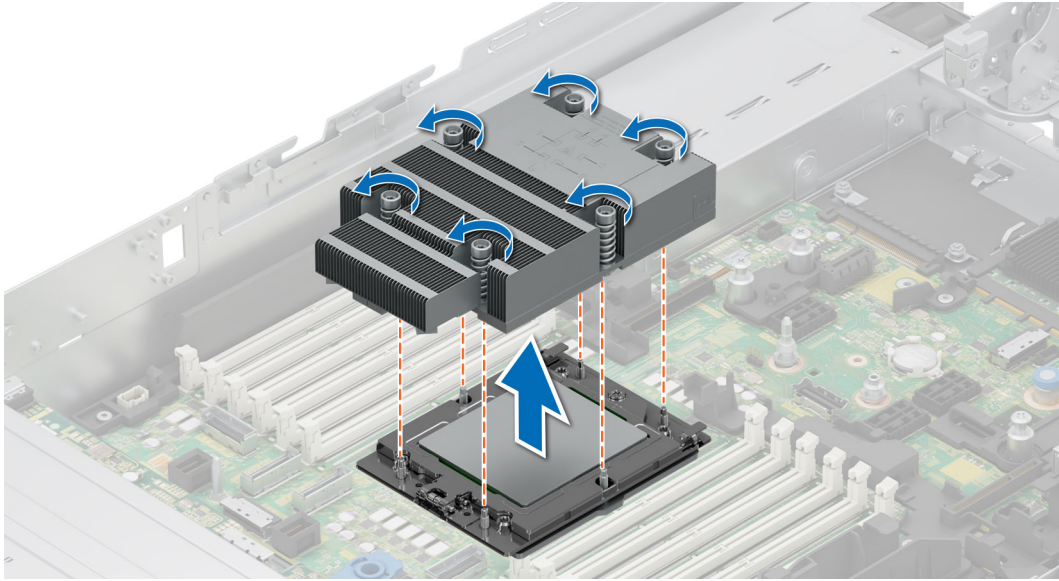


Figure 111. Removing a heat sink

#### Next steps

1. If you are uninstalling a faulty heat sink, [replace the heat sink](#), else [remove the processor](#).

## Removing the liquid cooling heat sink modules

#### Prerequisites

1. Follow the safety guidelines listed in the [Safety instructions](#).
2. Follow the procedure listed in the [Before working inside your system](#).
3. If installed, [remove the air shroud](#).

**WARNING:** The liquid cooling heat sink modules and processor are too hot to touch for some time after the system has been powered off. Allow the heat sink and processor to cool down before handling them.

#### Steps

1. Using a Phillips #1 screw driver, loosen the captive screw on the liquid cooling ring holder.
2. Lift up the liquid cooling ring holder to loosen the liquid cooling tubes.
3. Disconnect the liquid cooling detection cable from the Rio card connector.

**NOTE:** The numbers on the image do not depict the exact steps. The numbers are for representation of sequence.

4. Remove the liquid cooling tubes end point from the rear exit of the I/O function panel.
5. Slightly lift up the liquid cooling tubes surrounding the DIMM slots.
6. Using a Torx #T20 screwdriver, loosen the captive screws in the order that is mentioned on the liquid cooling heat sink modules:
  - a. Partially loosen the captive screws 1 and 2 (approximately 3 turns).
  - b. Partially loosen the captive screws 3 and 4 (approximately 3 turns).
  - c. Loosen the captive screws 1 and 2 completely.
  - d. Loosen the captive screws 3 and 4 completely.

**NOTE:** The captive screw numbers are marked on the liquid cooling heat sink modules.

7. Lift the heat sink from the system.

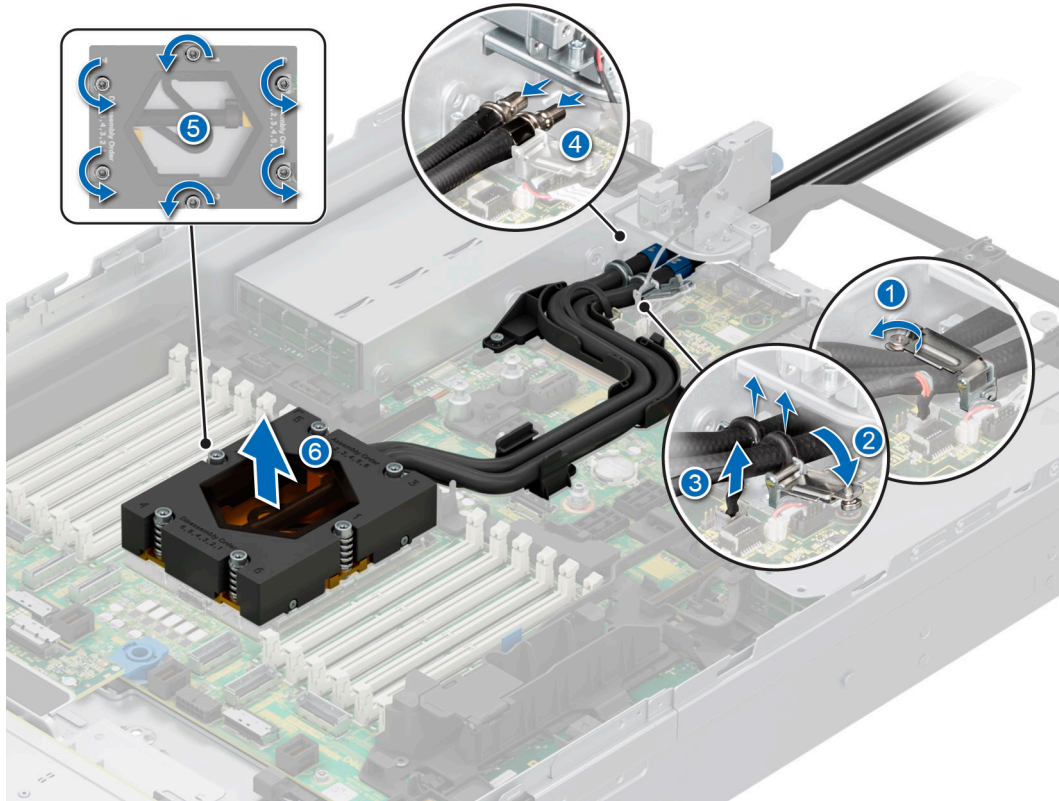


Figure 112. Removing the liquid cooling heat sink modules

### Next steps

1. If you are uninstalling a faulty heat sink, [replace the liquid cooling heat sink modules](#), else [remove the processor](#).

## Removing the processor

### Prerequisites

**⚠ WARNING:** The heat sink may be hot to touch for some time after the system has been powered off. Allow the heat sink to cool before removing it.

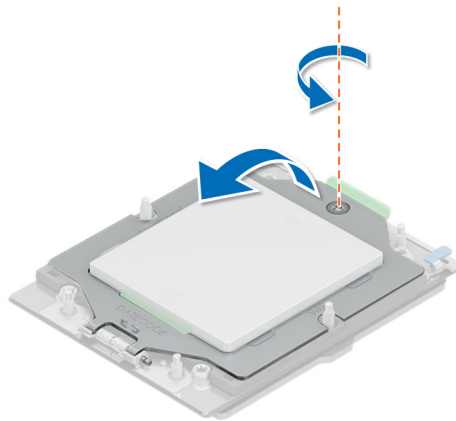
1. Follow the safety guidelines listed in the [Safety instructions](#).
2. Follow the procedure listed in the [Before working inside your system](#).
3. [Remove the heat sink](#).

**⚠ CAUTION:** You may find the CMOS battery loss or CMOS checksum error is displayed during the first instance of powering on the system after the processor or system board replacement which is expected. To fix, go to [set up](#) option to configure the system settings.

### Steps

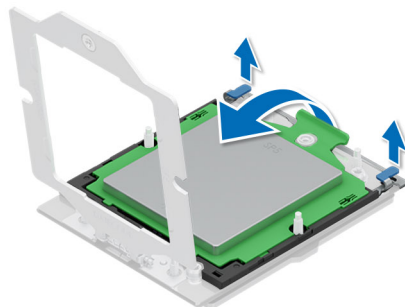
1. Using a Torx #T20 screwdriver, loosen the middle screw to release the retention frame. Hold and lift the retention frame upwards and rotate it slightly past the vertical position (105 degrees).

**i NOTE:** The spring loading will keep the retention frame at its "open" position.



**Figure 113. Removing screws on the retention frame**

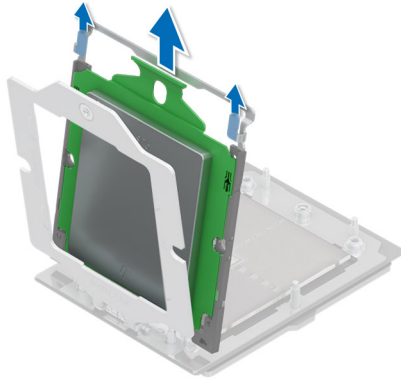
2. Release the processor socket rail frame by holding both blue tabs to lift the blue latches.



**Figure 114. Lifting the rail frame**

3. Holding the handle on the carrier frame, slide the tray out of the rail frame.





**Figure 115. Removing the carrier frame**

#### **Next steps**

1. [Replace the processor.](#)

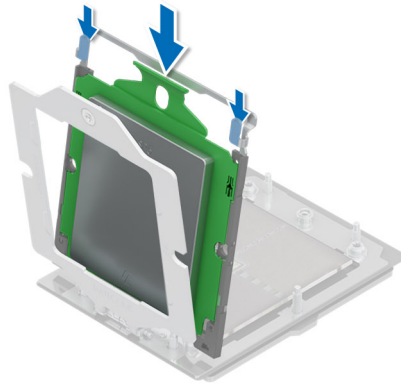
## **Installing the processor**

#### **Prerequisites**

1. Follow the safety guidelines listed in the [Safety instructions](#).
2. Follow the procedure listed in [Before working inside your system](#).
3. [Remove the heat sink](#).

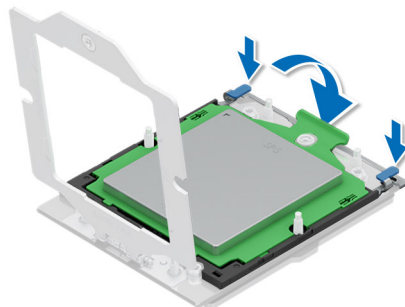
#### **Steps**

1. Holding the handle of the carrier frame, slide the tray into the processor socket rail frame until firmly seated.



**Figure 116. Placing the carrier frame into the rail frame**

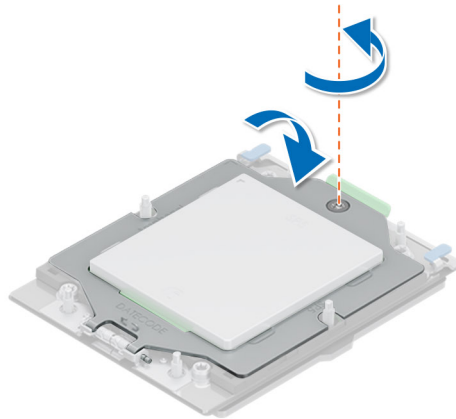
2. Holding both of blue tabs to push the rail frame down until the blue latches lock into place.



**Figure 117. Closing the rail frame**

3. Secure the retention frame by holding down the retention frame with one hand while using the other hand to operate the screw driver to engage and tighten screw.

**NOTE:** Press the retention frame while tightening the screws to avoid tilting of the processor cover out of the processor socket.



**Figure 118. Securing the retention frame**

#### Next steps

1. [Install the heat sink.](#)
2. Follow the procedure listed in [After working inside your system.](#)

## Installing the heat sink

#### Prerequisites

Never uninstall the heat sink from a processor unless you intend to replace the processor or system board. The heat sink is necessary to maintain proper thermal conditions.

1. Follow the safety guidelines listed in the [Safety instructions.](#)
2. Follow the procedure listed in the [Before working inside your system.](#)
3. If installed, [remove the air shroud.](#)
4. If installed, remove the processor dust cover.

**i** **NOTE:** The procedure to install standard and L-type heat sink is similar.

#### Steps

1. If you are using an existing heat sink, remove the thermal grease on the heat sink by using a clean lint-free cloth.

**i** **NOTE:** For a new heat sink, the thermal paste is pre-applied to the heat sink. Remove the protective cover, and install the heat sink.

2. Use the thermal grease syringe included with your processor kit to apply the grease in a thin spiral on the top of the processor.

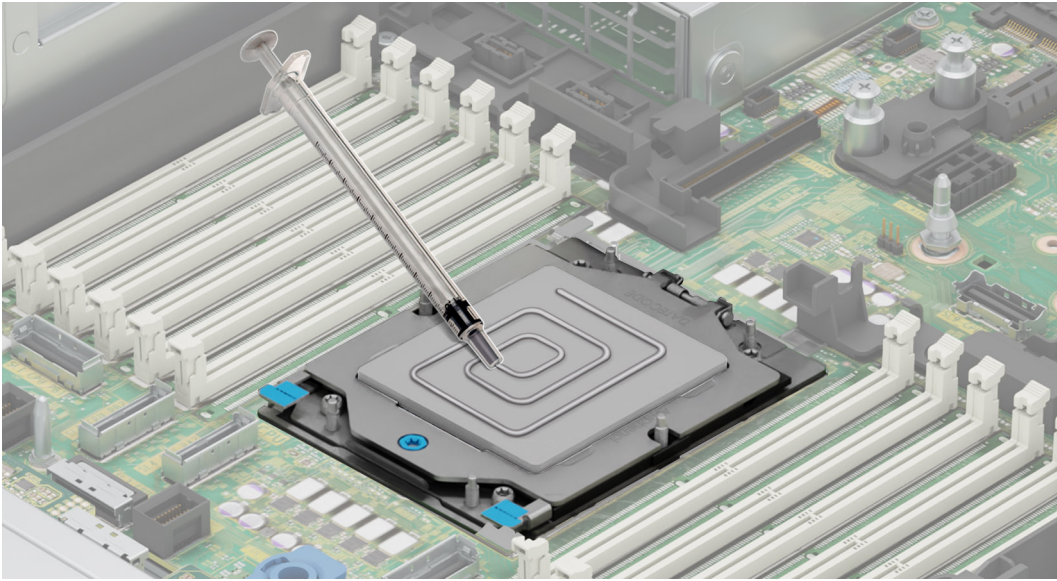


Figure 119. Applying thermal grease

**CAUTION:** Applying too much thermal grease can result in excess grease coming in contact with and contaminating the processor socket.

**NOTE:** The thermal grease syringe is intended for single use only. Dispose of the syringe after you use it.

**NOTE:** Refer to the airflow direction on heat sink label as visual hint of heat sink install orientation.

3. Align the screws on the heat sink with the standoff screws on the system board.

**NOTE:** The A1 extrusion on the L-type heat sink should face towards the system side.

4. Using a Torx #T20 screwdriver, fully tighten the captive screw all the way down before moving to the next screw (on one-screw-at-a-time basis).

**NOTE:** Follow the screw sequence defined on heat sink label. Assembly order: 1, 2, 3, 4, 5, 6

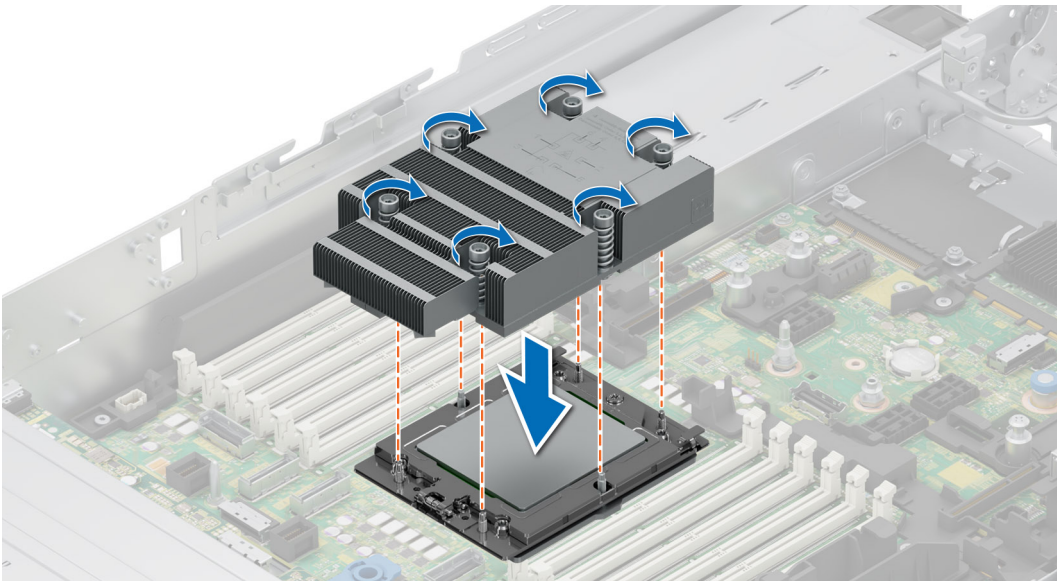


Figure 120. Installing the heat sink

## Next steps

1. If removed, [install the air shroud](#).
2. Follow the procedure listed in the [After working inside your system](#).


# Installing the liquid cooling heat sink

## Prerequisites

Never uninstall the heat sink from a processor unless you intend to replace the processor or system board. The heat sink is necessary to maintain proper thermal conditions.


1. Follow the safety guidelines listed in the [Safety instructions](#).
2. Follow the procedure listed in the [Before working inside your system](#).
3. If installed, [remove the air shroud](#).
4. If installed, remove the processor dust cover.
5. For new heat sinks, refer to [Installing the heat sink](#) step 1 and 2 for applying the thermal grease.

 **NOTE:** Ensure anti-tilt wires on the DLC module are in the unlocked position.


 **NOTE:** The recommended maximum operating pressure is 15 psi (diverter opens at 15 psi).

## Steps

1. Align the screws on the liquid cooling heat sink with the standoff screws on the system board. Ensure that the liquid cooling tubes and liquid detection cable are placed towards the rear of the chassis. Using a Torx #T20 screwdriver, tighten the captive screws in the order that is mentioned below:

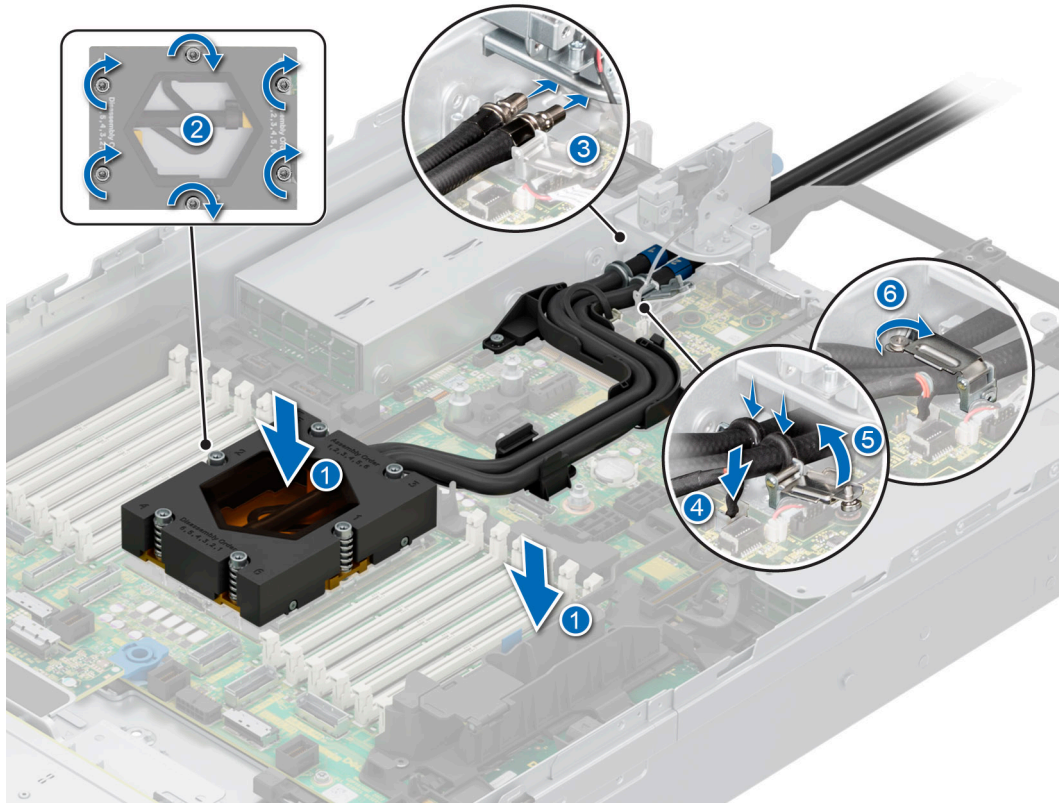
 **NOTE:** The captive screw numbers are marked on the heat sink and are tightened to a torque value of  $12.0 \pm 1.2$  lbf-in.

- a. Partially tighten the captive screws 1 and 2 (approximately 3 turns).
  - b. Partially tighten the captive screws 3 and 4 (approximately 3 turns).
  - c. Tighten the captive screws 1 and 2 completely.
  - d. Tighten the captive screws 3 and 4 completely.
2. Ensure that the liquid cooling tubes leading towards the front of the chassis are placed between the DIMM slots and the J\_SL connectors. And the tubes leading towards the rear of the chassis are placed in between the DIMM slots and the relay components.

 **NOTE:** Liquid detection cable must be placed underneath the cooling tubes to ensure it does not interfere with the PCIe risers.

3. Route the liquid cooling tubes through the rear exit point next to the I/O function panel. Ensure the routing follows the numbered labels on the tube and liquid cooling ring holder (1, 2).
4. Connect the liquid cooling detection cable to the RIO card connector.
5. Insert the rubber rings on the tubes on to the rubber holder.
6. Using a Phillips #1 screwdriver, tighten the captive screw on the liquid cooling ring holder to secure it in place.

 **NOTE:** The numbers on the image do not depict the exact steps. The numbers are for representation of sequence.



**Figure 121. Installing the liquid cooling heat sink**

### Next steps

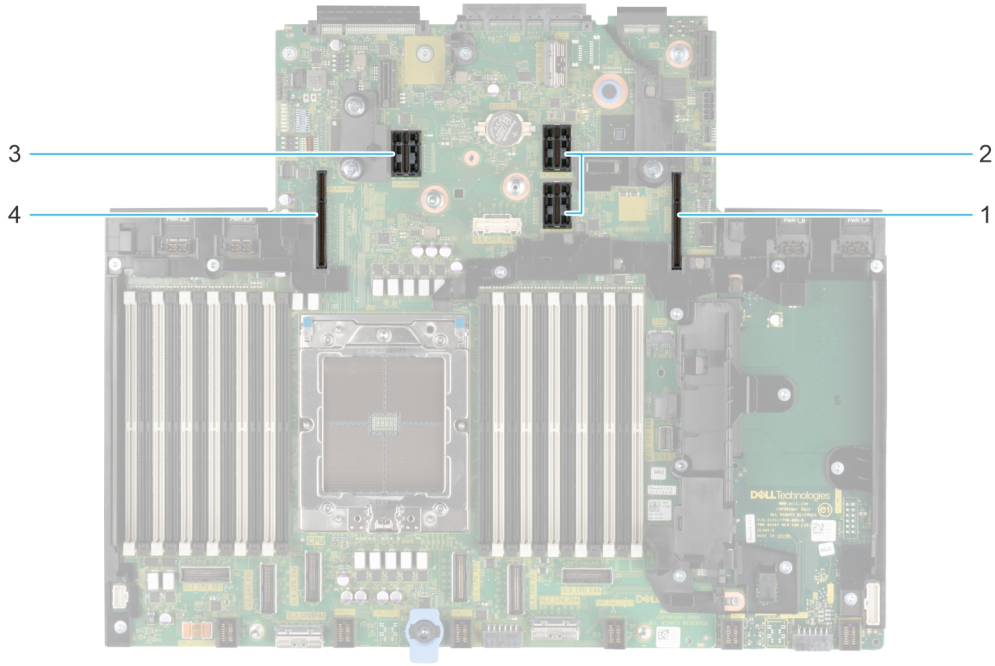
1. If removed, [install the air shroud](#).
2. Follow the procedure listed in the [After working inside your system](#).

## Expansion cards and expansion card risers

**NOTE:** A system event entry is logged in the iDRAC Lifecycle Controller if an expansion card riser is not supported or missing. It does not prevent your system from turning on. However, if a F1/F2 pause occurs with an error message, see [Troubleshooting expansion cards](#) section in the *Dell PowerEdge Servers Troubleshooting Guide* at [www.dell.com/poweredgemanuals](http://www.dell.com/poweredgemanuals).

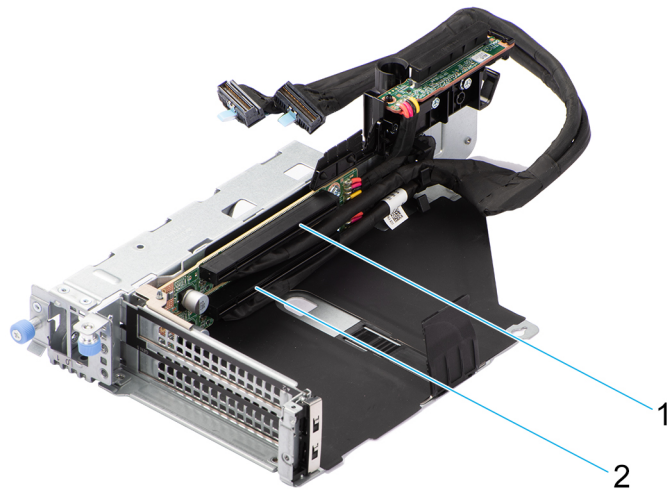
# Expansion card installation guidelines

The following table describes the supported expansion cards and riser configurations:



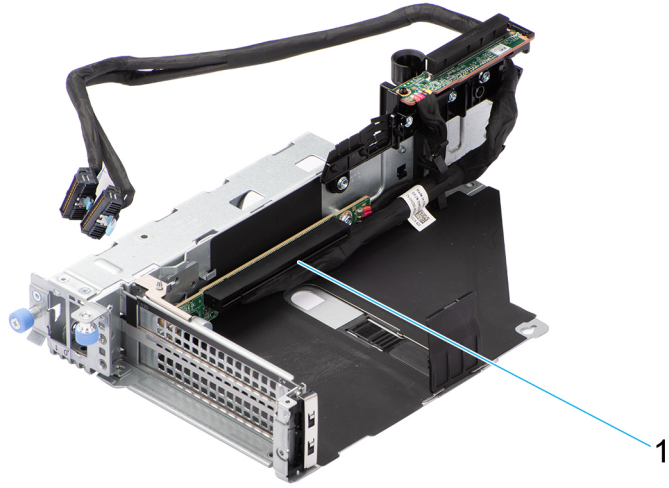
**Figure 122. Expansion card riser slot connectors**

- 1. Riser 1
- 2. Riser 2
- 3. Riser 3
- 4. Riser 4



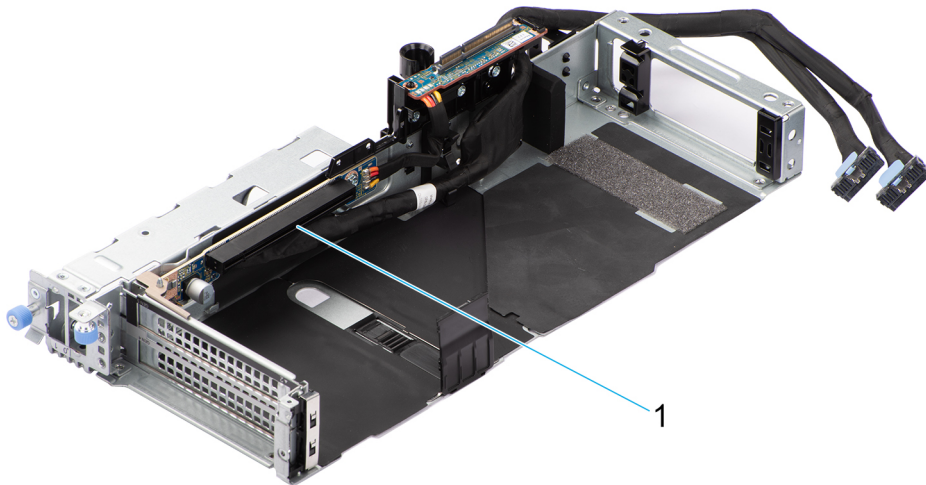
**Figure 123. R1U**

- 1. Slot 1
- 2. Slot 2



**Figure 124. R1T**

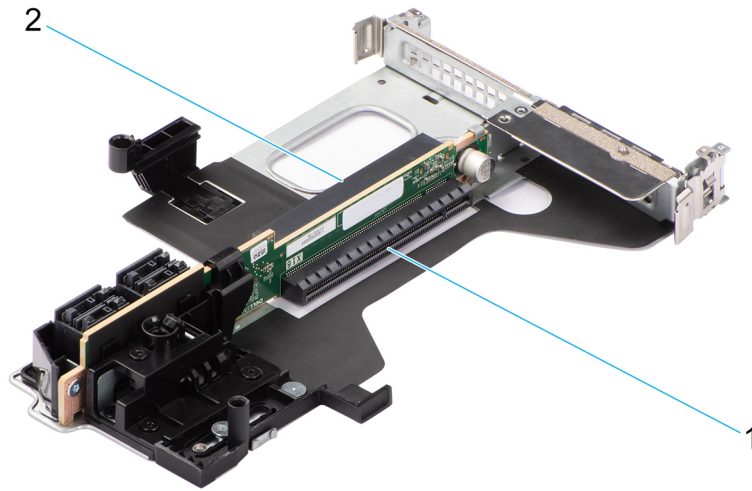
1. Slot 2



**Figure 125. R1T**

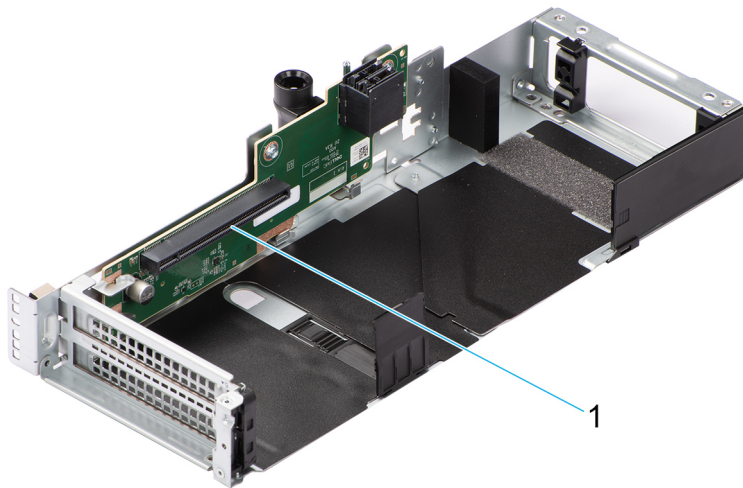
1. Slot 2





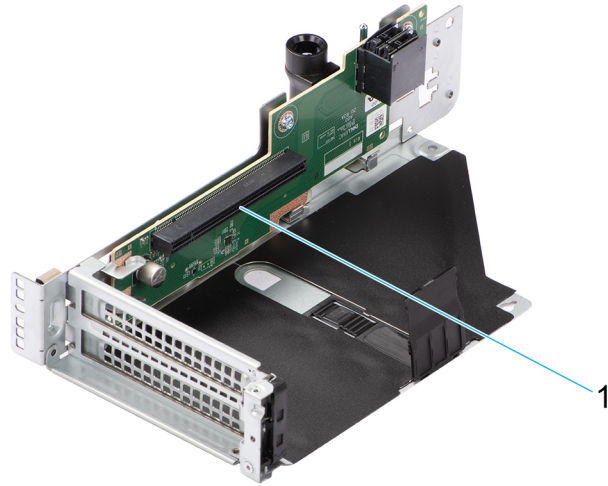
**Figure 126. R2A**

- 1. Slot 3
- 2. Slot 6



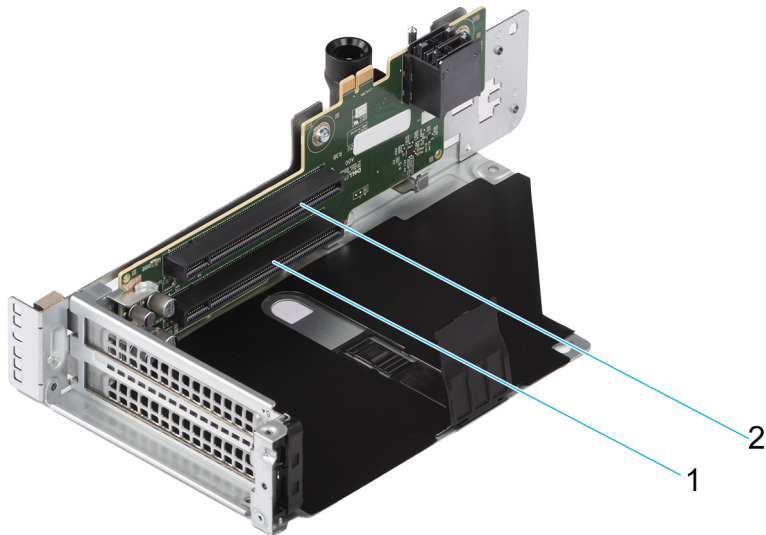
**Figure 127. R3A**

- 1. Slot 5



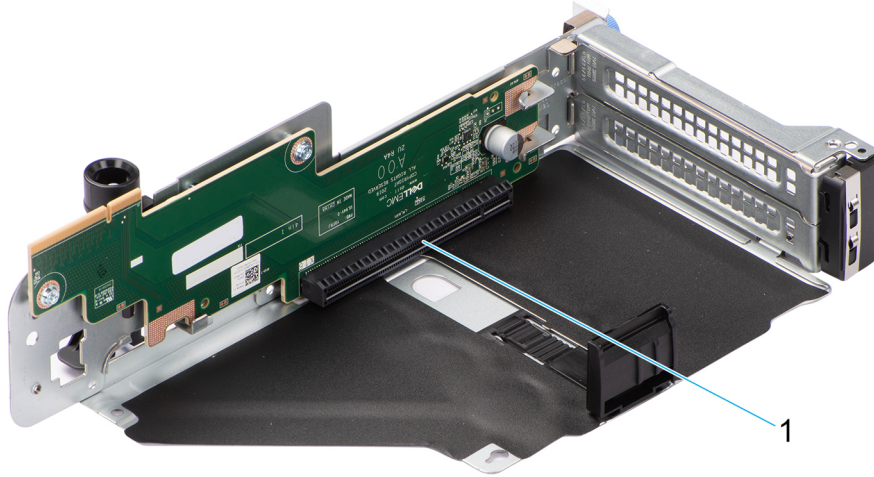
**Figure 128. R3A**

1. Slot 5



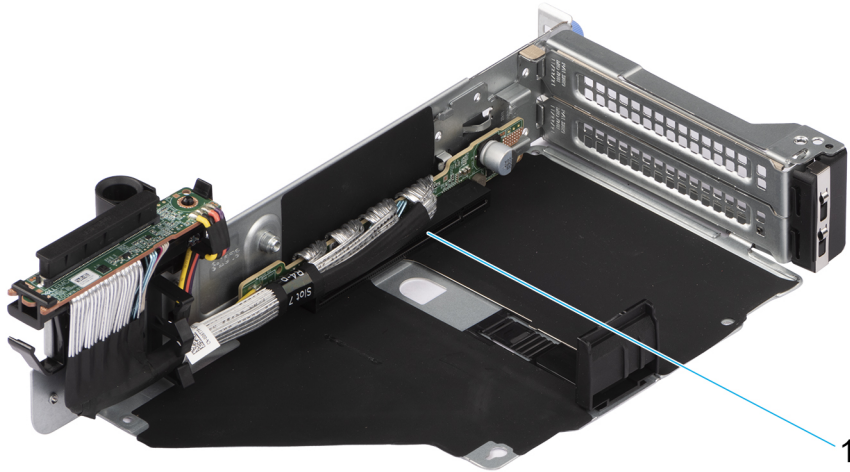
**Figure 129. R3B**

1. Slot 4
2. Slot 5



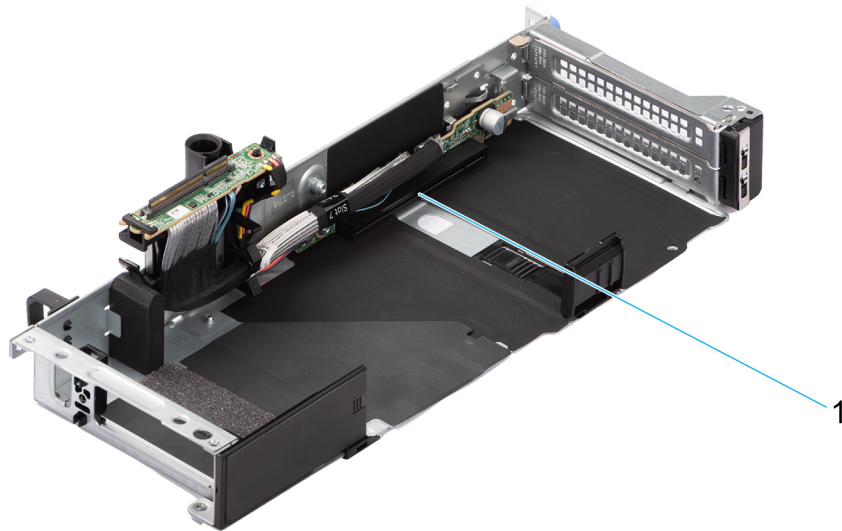
**Figure 130. R4A**

1. Slot 7



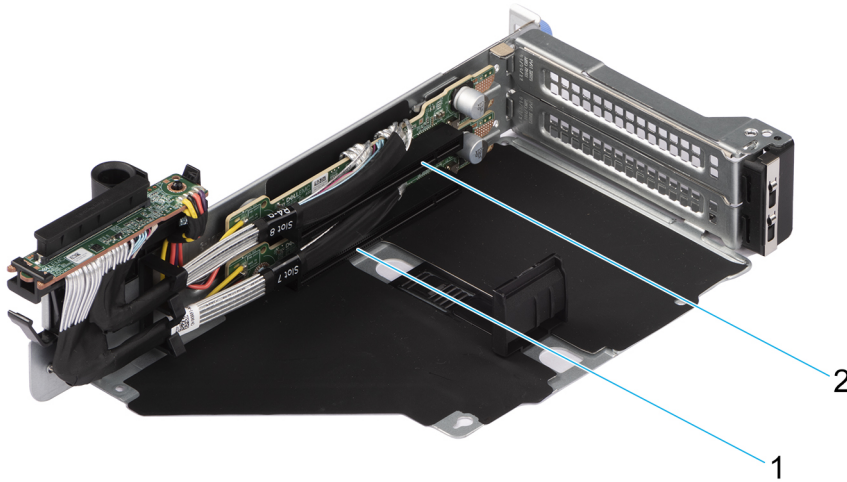
**Figure 131. R4P**

1. Slot 7



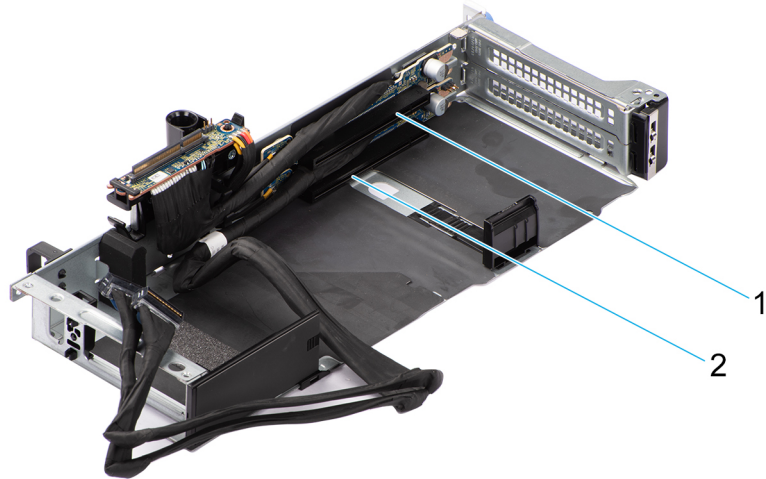
**Figure 132. R4P**

1. Slot 7



**Figure 133. R4Q**

1. Slot 7
2. Slot 8



**Figure 134. R4S**

- 1. Slot 7
- 2. Slot 8

**Table 96. Expansion card riser configurations**

Configurations	Expansion card risers	PCIe Slots	Form factor	Controlling processor	Slot's electrical bandwidth/ physical connector
Config1. 2 x16 FH + 2 x8 LP	R2A	3	Low Profile	Processor 1	PCIe Gen4 x8 (x16 connector)
		6	Low Profile	Processor 1	PCIe Gen4 x8 (x16 connector)
	R3A	5	Full Height	Processor 1	PCIe Gen4 x16 (x16 connector)
	R4P	7	Full Height	Processor 1	PCIe Gen5 x16 (x16 connector)
Config2. 6 x8 FH + 2 x8 LP	R1U	1	Full Height	Processor 1	PCIe Gen5 x8 (x16 connector)
		2	Full Height	Processor 1	PCIe Gen5 x8 (x16 connector)
	R2A	3	Low Profile	Processor 1	PCIe Gen4 x8 (x16 connector)
		6	Low Profile	Processor 1	PCIe Gen4 x8 (x16 connector)
	R3B	4	Full Height	Processor 1	PCIe Gen4 x8 (x16 connector)
		5	Full Height	Processor 1	PCIe Gen4 x8 (x16 connector)
	R4Q	7	Full Height	Processor 1	PCIe Gen5 x8 (x16 connector)
		8	Full Height	Processor 1	PCIe Gen5 x8 (x16 connector)

**Table 96. Expansion card riser configurations (continued)**

<b>Configurations</b>	<b>Expansion card risers</b>	<b>PCIe Slots</b>	<b>Form factor</b>	<b>Controlling processor</b>	<b>Slot's electrical bandwidth/ physical connector</b>
Config3-1. 2 x16 LP + 2 x8 FH + 2 x16 FH	R1t	1	Full Height	Processor 1	PCIe Gen5 x16 (x16 connector)
	R2t	3	Low Profile	Processor 1	PCIe Gen4 x16 (x16 connector)
		6	Low Profile	Processor 1	PCIe Gen4 x16 (x16 connector)
	R3B	4	Full Height	Processor 1	PCIe Gen4 x8 (x16 connector)
		5	Full Height	Processor 1	PCIe Gen4 x8 (x16 connector)
	R4P	7	Full Height	Processor 1	PCIe Gen5 x16 (x16 connector)
Config3-2. 2 x16 LP + 2 x8 FH + 2 x16 DW	R1t	1	Full Height (DW)	Processor 1	PCIe Gen5 x16 (x16 connector)
	R2t	3	Low Profile	Processor 1	PCIe Gen4 x16 (x16 connector)
		6	Low Profile	Processor 1	PCIe Gen4 x16 (x16 connector)
	R3B	4	Full Height	Processor 1	PCIe Gen4 x8 (x16 connector)
		5	Full Height	Processor 1	PCIe Gen4 x8 (x16 connector)
	R4P	7	Full Height (DW)	Processor 1	PCIe Gen5 x16 (x16 connector)
Config4-1. 2 x16 LP, 3 x16 FH	R1t	1	Full Height	Processor 1	PCIe Gen5 x16 (x16 connector)
	R2t	3	Low Profile	Processor 1	PCIe Gen4 x16 (x16 connector)
		6	Low Profile	Processor 1	PCIe Gen4 x16 (x16 connector)
	R3A	5	Full Height	Processor 1	PCIe Gen4 x16 (x16 connector)
	R4P	7	Full Height	Processor 1	PCIe Gen5 x16 (x16 connector)
Config4-2. 2 x16 LP, 3 x16 DW	R1t	1	Full Height (DW)	Processor 1	PCIe Gen5 x16 (x16 connector)
	R2t	3	Low Profile	Processor 1	PCIe Gen4 x16 (x16 connector)
		6	Low Profile	Processor 1	PCIe Gen4 x16 (x16 connector)
	R3A	5	Full Height (DW)	Processor 1	PCIe Gen4 x16 (x16 connector)
	R4P	7	Full Height (DW)	Processor 1	PCIe Gen5 x16 (x16 connector)

**Table 96. Expansion card riser configurations (continued)**

<b>Configurations</b>	<b>Expansion card risers</b>	<b>PCIe Slots</b>	<b>Form factor</b>	<b>Controlling processor</b>	<b>Slot's electrical bandwidth/ physical connector</b>
Config5-1. 6 x16 SW (HL)	R1t	1	Full Height	Processor 1	PCIe Gen5 x16 (x16 connector)
	R2t	3	Low Profile	Processor 1	PCIe Gen4 x16 (x16 connector)
		6	Low Profile	Processor 1	PCIe Gen4 x16 (x16 connector)
	R3A	5	Full Height	Processor 1	PCIe Gen4 x16 (x16 connector)
	R4S	7	Full Height	Processor 1	PCIe Gen5 x16 (x16 connector)
		8	Full Height	Processor 1	PCIe Gen5 x16 (x16 connector)
Config5-2. 6 x16 SW (FL)	R1t	1	Full Height (DW)	Processor 1	PCIe Gen5 x16 (x16 connector)
	R2t	3	Low Profile	Processor 1	PCIe Gen4 x16 (x16 connector)
		6	Low Profile	Processor 1	PCIe Gen4 x16 (x16 connector)
	R3A	5	Full Height	Processor 1	PCIe Gen4 x16 (x16 connector)
	R4S	7	Full Height	Processor 1	PCIe Gen5 x16 (x16 connector)
		8	Full Height	Processor 1	PCIe Gen5 x16 (x16 connector)
Config6. 2 x16 LP + 2 x8 FH	R2t	3	Low Profile	Processor 1	PCIe Gen5 x16 (x16 connector)
		6	Low Profile	Processor 1	PCIe Gen4 x16 (x16 connector)
	R4Q	7	Full Height	Processor 1	PCIe Gen5 x8 (x16 connector)
		8	Full Height	Processor 1	PCIe Gen5 x8 (x16 connector)
Config7. 4 x8 FH + 2 x16 LP	R1U	1	Full Height	Processor 1	PCIe Gen5 x8 (x16 connector)
		2	Full Height	Processor 1	PCIe Gen5 x8 (x16 connector)
	R2t	3	Low Profile	Processor 1	PCIe Gen4 x16 (x16 connector)
		6	Low Profile	Processor 1	PCIe Gen4 x16 (x16 connector)
	R4Q	7	Full Height	Processor 1	PCIe Gen5 x8 (x16 connector)
		8	Full Height	Processor 1	PCIe Gen5 x8 (x16 connector)

**Table 96. Expansion card riser configurations (continued)**

Configurations	Expansion card risers	PCIe Slots	Form factor	Controlling processor	Slot's electrical bandwidth/ physical connector
Config8. 1 x16 FH + 2 x8 LP	R2A	3	Low Profile	Processor 1	PCIe Gen4 x8 (x16 connector)
	R4A	6	Low Profile	Processor 1	PCIe Gen4 x8 (x16 connector)
		7	Full Height	Processor 1	PCIe Gen4 x16 (x16 connector)
Config9. 1 x16 FH + 2 x8 LP	R2A	3	Low Profile	Processor 1	PCIe Gen4 x8 (x16 connector)
		6	Low Profile	Processor 1	PCIe Gen4 x8 (x16 connector)
	R3A	5	Full Height	Processor 1	PCIe Gen4 x16 (x16 connector)
	R4P	7	Full Height	Processor 1	PCIe Gen5 x16 (x16 connector)
Config10. 1 x 16 FH, 2 x 8 LP	R1U	1	Full Height	Processor 1	PCIe Gen5 x16 (x16 connector)
		2	Full Height	Processor 1	PCIe Gen5 x16 (x16 connector)
	R3B	4	Full Height	Processor 1	PCIe Gen5 x16 (x16 connector)
		5	Full Height	Processor 1	PCIe Gen5 x16 (x16 connector)
	R4Q	7	Full Height	Processor 1	PCIe Gen5 x16 (x16 connector)
		8	Full Height	Processor 1	PCIe Gen5 x16 (x16 connector)

**NOTE:** The expansion-card slots are not hot-swappable.

The following table provides guidelines for installing expansion cards to ensure proper cooling and mechanical fit. The expansion cards with the highest priority should be installed first using the slot priority indicated. All the other expansion cards should be installed in the card priority and slot priority order.

**Table 97. Config 0: No riser – CPU**

Card Type	Slot Priority	Maximum number of cards
FOXCONN (Front PERC)	Integrated slot	1
FOXCONN (Front PERC)	Integrated slot	1
Inventec (LOM Card)	Integrated slot	1
Inventec (LOM Card)	Integrated slot	1
Intel (OCP: 25Gb)	Integrated slot	1
Intel (OCP: 25Gb)	Integrated slot	1
Mellanox (OCP: 25Gb)	Integrated slot	1
Broadcom (OCP: 25Gb)	Integrated slot	1



**Table 97. Config 0: No riser – CPU (continued)**

Card Type	Slot Priority	Maximum number of cards
Broadcom (OCP: 25Gb)	Integrated slot	1
Broadcom (OCP: 25Gb)	Integrated slot	1
Broadcom (OCP: 25Gb)	Integrated slot	1
Broadcom(OCP: 25Gb)	Integrated slot	1
Broadcom (OCP: 25Gb)	Integrated slot	1
Intel (OCP: 10Gb)	Integrated slot	1
Intel (OCP: 10Gb)	Integrated slot	1
Intel (OCP: 10Gb)	Integrated slot	1
Broadcom (OCP: 10Gb)	Integrated slot	1
Broadcom (OCP: 10Gb)	Integrated slot	1
Intel (OCP: 10Gb)	Integrated slot	1
Broadcom (OCP: 10Gb)	Integrated slot	1
FOXCONN (BOSS)	Integrated slot	1
FOXCONN (BOSS)	Integrated slot	1

**Table 98. Config1. R2A+R3A+R4P (HL)**

Card type	Slot priority	Maximum number of cards
Nvidia (GPU)	5,7	2
Nvidia (GPU)	5,7	2
FOXCONN (Front PERC)	Integrated slot	2
FOXCONN (Front PERC)	Integrated slot	2
FOXCONN (Front PERC)	Integrated slot	2
FOXCONN (Front PERC)	Integrated slot	1
FOXCONN (Front PERC)	Integrated slot	1
FOXCONN (Front PERC)	Integrated slot	1
FOXCONN (Front PERC)	Integrated slot	1
FOXCONN (External Adapter)	3,6	2
External Adapter	3,6,5,7	4
External Adapter	3,6,5,7	4
Inventec (LOM Card)	Integrated slot	1
Inventec (LOM Card)	Integrated slot	1
Inventec (Paige Card)	Integrated slot	1
Inventec (Melody Card)	Integrated slot	1
Pensando (SmartNIC: 100Gb)	7	1
IntelSmart (NIC: 100Gb)	7	1
Nvidia (Mellanox) (SmartNIC: 100Gb)	7	1
PensandoSmartNIC: 25Gb	7	1

**Table 98. Config1. R2A+R3A+R4P (HL) (continued)**

<b>Card type</b>	<b>Slot priority</b>	<b>Maximum number of cards</b>
Nvidia (MLNX) (SmartNIC: 25Gb)	7	1
Intel (SmartNIC: 25Gb)	7	1
Mellanox (NIC: 400Gb)	7	1
Broadcom (NIC: 100Gb)	5,7	2
Intel (NIC: 100Gb)	5,7	2
Intel (NIC: 100Gb)	3,6	2
Mellanox (NIC: 100Gb)	5,7	2
Intel (NIC: 100Gb)	5,7	2
Intel (NIC: 25Gb)	5,7	2
Intel (NIC: 25Gb)	3,6	2
Intel (NIC: 25Gb)	5,7	2
MellanoxNIC: 25Gb	5,7	2
Broadcom (NIC: 25Gb)	5,7	2
Broadcom (NIC: 25Gb)	3,6	2
Broadcom (NIC: 25Gb)	5,7	2
Broadcom (HBA: FC64)	5,7	2
Broadcom (HBA: FC64)	3,6	2
Broadcom (HBA: FC32)	5,7	2
Broadcom (HBA: FC32)	3,6	2
Broadcom (HBA: FC32)	5,7	2
Broadcom (HBA: FC32)	3,6	2
Broadcom (HBA: FC32)	5,7	2
Marvell (HBA: FC32)	5,7	2
Marvell (HBA: FC32)	3,6	2
Marvell (HBA: FC32)	5,7	2
Marvell (HBA: FC32)	3,6	2
Broadcom (NIC: 10Gb)	5,7	2
Broadcom (NIC: 10Gb)	3,6	2
Broadcom (NIC: 10Gb)	5,7	2
Broadcom (NIC: 10Gb)	3,6	2
Intel (NIC: 10Gb)	5,7	2
Intel (NIC: 10Gb)	3,6	2
Intel (NIC: 10Gb)	5,7	2
Intel (NIC: 10Gb)	3,6	2
Intel (NIC: 1Gb)	3,6	2
Intel (NIC: 1Gb)	5,7	2
Broadcom (NIC: 1Gb)	5,7	2

**Table 98. Config1. R2A+R3A+R4P (HL) (continued)**

Card type	Slot priority	Maximum number of cards
Broadcom (NIC: 1Gb)	3,6	2
Intel (NIC: 1Gb)	3,6	2
Intel (NIC: 1Gb)	5,7	2
Broadcom (NIC: 1Gb)	5,7	2
Broadcom (NIC: 1Gb)	3,6	2
Mellanox (NIC: NDR200)	5,7	2
Mellanox (NIC: HDRV)	5,7	2
Intel (OCP: 25Gb)	Integrated slot	1
Intel (OCP: 25Gb)	Integrated slot	1
Mellanox (OCP: 25Gb)	Integrated slot	1
Broadcom (OCP: 25Gb)	Integrated slot	1
Broadcom (OCP: 25Gb)	Integrated slot	1
Broadcom (OCP: 25Gb)	Integrated slot	1
Broadcom (OCP: 25Gb)	Integrated slot	1
Broadcom (OCP: 10Gb)	Integrated slot	1
Broadcom (OCP: 10Gb)	Integrated slot	1
Intel (OCP: 10Gb)	Integrated slot	1
Intel (OCP: 10Gb)	Integrated slot	1
Broadcom (OCP: 10Gb)	Integrated slot	1
Broadcom (OCP: 1Gb)	Integrated slot	1
Intel (OCP: 1Gb)	Integrated slot	1
Broadcom (OCP: 1Gb)	Integrated slot	1
FOXCONN (BOSS)	Integrated slot	1
FOXCONN (BOSS)	Integrated slot	1

**Table 99. Config2. R1U+R2A+R3B+R4Q**

Card type	Slot priority	Maximum number of cards
Inventec (2U serial board)	8	1
Nvidia (GPU)	1,2,4,5,7,8	6
Nvidia (GPU)	1,2,4,5,7,8	6
FOXCONN (Front PERC)	Integrated slot	2
FOXCONN (Front PERC)	Integrated slot	2
FOXCONN (Front PERC)	Integrated slot	2
FOXCONN (Front PERC)	Integrated slot	1
FOXCONN (Front PERC)	Integrated slot	1
FOXCONN (Front PERC)	Integrated slot	1
FOXCONN (Front PERC)	Integrated slot	1
FOXCONN (PERC Adapter)	3	1

**Table 99. Config2. R1U+R2A+R3B+R4Q (continued)**

<b>Card type</b>	<b>Slot priority</b>	<b>Maximum number of cards</b>
FOXCONN (PERC Adapter)	3	1
FOXCONN (PERC Adapter)	3	1
FOXCONN (External Adapter)	3,6	2
External Adapter	3,6,1,2,4,5,7,8	8
External Adapter	3,6,1,2,4,5,7,8	8
Inventec (LOM Card)	Integrated slot	1
Inventec (LOM Card)	Integrated slot	1
Inventec (Paige Card)	Integrated slot	1
Inventec (Melody Card)	Integrated slot	1
IntelSmart (NIC: 100Gb)	7	1
Nvidia (MLNX) (SmartNIC: 25Gb)	7	1
Intel (SmartNIC: 25Gb)	7	1
Intel (NIC: 100Gb)	1,2,4,5,7,8	6
Intel (NIC: 100Gb)	3,6	2
Intel (NIC: 25Gb)	1,2,4,5,7,8	6
Intel (NIC: 25Gb)	3,6	2
Broadcom (NIC: 25Gb)	3,6	2
Broadcom (NIC: 25Gb)	1,2,4,5,7,8	6
Broadcom (HBA: FC64)	1,2,4,5,7,8	6
Broadcom (HBA: FC64)	3,6	2
Broadcom (HBA: FC32)	1,2,4,5,7,8	6
Broadcom (HBA: FC32)	3,6	2
Broadcom (HBA: FC32)	1,2,4,5,7,8	6
Broadcom (HBA: FC32)	3,6	2
Broadcom (HBA: FC32)	1,2,4,5,7,8	6
Marvell (HBA: FC32)	1,2,4,5,7,8	6
Marvell (HBA: FC32)	3,6	2
Marvell (HBA: FC32)	1,2,4,5,7,8	6
Marvell (HBA: FC32)	3,6	2
Broadcom (NIC: 10Gb)	1,2,4,5,7,8	6
Broadcom (NIC: 10Gb)	3,6	2
Broadcom (NIC: 10Gb)	1,2,4,5,7,8	6
Broadcom (NIC: 10Gb)	3,6	2
Intel (NIC: 10Gb)	1,2,4,5,7,8	6
Intel (NIC: 10Gb)	3,6	2
Intel (NIC: 10Gb)	1,2,4,5,7,8	6
Intel (NIC: 10Gb)	3,6	2

**Table 99. Config2. R1U+R2A+R3B+R4Q (continued)**

Card type	Slot priority	Maximum number of cards
Intel (NIC: 1Gb)	3,6	2
Intel (NIC: 1Gb)	1,2,4,5,7,8	6
Broadcom (NIC: 1Gb)	1,2,4,5,7,8	6
Broadcom (NIC: 1Gb)	3,6	2
Intel (NIC: 1Gb)	3,6	2
Intel (NIC: 1Gb)	1,2,4,5,7,8	6
Broadcom (NIC: 1Gb)	1,2,4,5,7,8	6
Broadcom (NIC: 1Gb)	3,6	2
Intel (OCP: 25Gb)	Integrated slot	1
Intel (OCP: 25Gb)	Integrated slot	1
Mellanox (OCP: 25Gb)	Integrated slot	1
Broadcom (OCP: 25Gb)	Integrated slot	1
Broadcom (OCP: 25Gb)	Integrated slot	1
Broadcom (OCP: 25Gb)	Integrated slot	1
Broadcom (OCP: 25Gb)	Integrated slot	1
Broadcom (OCP: 25Gb)	Integrated slot	1
Broadcom (OCP: 10Gb)	Integrated slot	1
Broadcom (OCP: 10Gb)	Integrated slot	1
Intel (OCP: 10Gb)	Integrated slot	1
Intel (OCP: 10Gb)	Integrated slot	1
Broadcom (OCP: 10Gb)	Integrated slot	1
Broadcom (OCP: 1Gb)	Integrated slot	1
Intel (OCP: 1Gb)	Integrated slot	1
Broadcom (OCP: 1Gb)	Integrated slot	1
FOXCONN (BOSS)	Integrated slot	1
FOXCONN (BOSS)	Integrated slot	1

**Table 100. Config3-1. R1T+R2T+R3B+R4P (HL)**

Card type	Slot priority	Maximum number of cards
Nvidia (GPU)	2,4,5,7	4
Nvidia (GPU)	2,4,5,7	4
FOXCONN (Front PERC)	Integrated slot	2
FOXCONN (Front PERC)	Integrated slot	2
FOXCONN (Front PERC)	Integrated slot	2
FOXCONN (Front PERC)	Integrated slot	1
FOXCONN (Front PERC)	Integrated slot	1
FOXCONN (Front PERC)	Integrated slot	1
FOXCONN (Front PERC)	Integrated slot	1
FOXCONN (PERC Adapter)	3	1

**Table 100. Config3-1. R1T+R2T+R3B+R4P (HL) (continued)**

<b>Card type</b>	<b>Slot priority</b>	<b>Maximum number of cards</b>
FOXCONN (PERC Adapter)	3	1
FOXCONN (PERC Adapter)	3	1
FOXCONN (External Adapter)	3,6	2
External Adapter	3,6,2,4,5,7	6
External Adapter	3,6,2,4,5,7	6
Inventec (LOM Card)	Integrated slot	1
Inventec (LOM Card)	Integrated slot	1
Inventec (Paige Card)	Integrated slot	1
Inventec (Melody Card)	Integrated slot	1
Pensando (SmartNIC: 100Gb)	7	1
IntelSmart (NIC: 100Gb)	7	1
Nvidia (Mellanox) (SmartNIC: 100Gb)	7	1
PensandoSmartNIC: 25Gb	7	1
Nvidia (MLNX) (SmartNIC: 25Gb)	7	1
Intel (SmartNIC: 25Gb)	7	1
Mellanox (NIC: 400Gb)	2,7	2
Mellanox (NIC: 400Gb)	3,6	2
Broadcom (NIC: 100Gb)	2,7	2
Broadcom (NIC: 100Gb)	3,6	2
Intel (NIC: 100Gb)	2,4,5,7	4
Intel (NIC: 100Gb)	3,6	2
Mellanox (NIC: 100Gb)	2,7	2
Mellanox (NIC: 100Gb)	3,6	2
Intel (NIC: 100Gb)	2,7	2
Intel (NIC: 100Gb)	3,6	2
Intel (NIC: 25Gb)	2,4,5,7	4
Intel (NIC: 25Gb)	3,6	2
Intel (NIC: 25Gb)	2,7	2
MellanoxNIC: 25Gb	2,7	2
MellanoxNIC: 25Gb	3,6	2
Broadcom (NIC: 25Gb)	2,7	2
Broadcom (NIC: 25Gb)	3,6	2
Broadcom (NIC: 25Gb)	2,4,5,7	4
Broadcom (HBA: FC64)	2,4,5,7	4
Broadcom (HBA: FC64)	3,6	2
Broadcom (HBA: FC32)	2,4,5,7	4
Broadcom (HBA: FC32)	3,6	2

**Table 100. Config3-1. R1T+R2T+R3B+R4P (HL) (continued)**

<b>Card type</b>	<b>Slot priority</b>	<b>Maximum number of cards</b>
Broadcom (HBA: FC32)	2,4,5,7	4
Broadcom (HBA: FC32)	3,6	2
Broadcom (HBA: FC32)	2,4,5,7	4
Marvell (HBA: FC32)	2,4,5,7	4
Marvell (HBA: FC32)	3,6	2
Marvell (HBA: FC32)	2,4,5,7	4
Marvell (HBA: FC32)	3,6	2
Broadcom (NIC: 10Gb)	2,4,5,7	4
Broadcom (NIC: 10Gb)	3,6	2
Broadcom (NIC: 10Gb)	2,4,5,7	4
Broadcom (NIC: 10Gb)	3,6	2
Intel (NIC: 10Gb)	2,4,5,7	4
Intel (NIC: 10Gb)	3,6	2
Intel (NIC: 10Gb)	2,4,5,7	4
Intel (NIC: 10Gb)	3,6	2
Intel (NIC: 1Gb)	3,6	2
Intel (NIC: 1Gb)	2,4,5,7	4
Broadcom (NIC: 1Gb)	2,4,5,7	4
Broadcom (NIC: 1Gb)	3,6	2
Intel (NIC: 1Gb)	3,6	2
Intel (NIC: 1Gb)	2,4,5,7	4
Broadcom (NIC: 1Gb)	2,4,5,7	4
Broadcom (NIC: 1Gb)	3,6	2
Mellanox (NIC: NDR200)	2,7	2
Mellanox (NIC: NDR200)	3,6	2
Mellanox (NIC: HDRV)	2,7	2
Mellanox (NIC: HDRV)	3,6	2
Intel (OCP: 25Gb)	Integrated slot	1
Intel (OCP: 25Gb)	Integrated slot	1
Mellanox (OCP: 25Gb)	Integrated slot	1
Broadcom (OCP: 25Gb)	Integrated slot	1
Broadcom (OCP: 25Gb)	Integrated slot	1
Broadcom (OCP: 25Gb)	Integrated slot	1
Broadcom (OCP: 25Gb)	Integrated slot	1
Broadcom (OCP: 10Gb)	Integrated slot	1
Broadcom (OCP: 10Gb)	Integrated slot	1
Intel (OCP: 10Gb)	Integrated slot	1

**Table 100. Config3-1. R1T+R2T+R3B+R4P (HL) (continued)**

Card type	Slot priority	Maximum number of cards
Intel (OCP: 10Gb)	Integrated slot	1
Broadcom (OCP: 10Gb)	Integrated slot	1
Broadcom (OCP: 1Gb)	Integrated slot	1
Intel (OCP: 1Gb)	Integrated slot	1
Broadcom (OCP: 1Gb)	Integrated slot	1
FOXCONN (BOSS)	Integrated slot	1
FOXCONN (BOSS)	Integrated slot	1

**Table 101. Config3-2. R1T+R2T+R3B+R4P (FL)**

Card type	Slot priority	Maximum number of cards
Nvidia (GPU)	2,7	2
Nvidia (GPU)	2,7	2
Nvidia (GPU)	2,7	2
Nvidia (GPU)	2,7	2
Nvidia (GPU)	2,7	2
AMD (GPU)	2,7	2
Nvidia (GPU)	2,4,5,7	4
Nvidia (GPU)	2,4,5,7	4
FOXCONN (Front PERC)	Integrated slot	2
FOXCONN (Front PERC)	Integrated slot	2
FOXCONN (Front PERC)	Integrated slot	2
FOXCONN (Front PERC)	Integrated slot	1
FOXCONN (Front PERC)	Integrated slot	1
FOXCONN (Front PERC)	Integrated slot	1
FOXCONN (Front PERC)	Integrated slot	1
FOXCONN (Front PERC)	Integrated slot	1
FOXCONN (PERC Adapter)	3	1
FOXCONN (PERC Adapter)	3	1
FOXCONN (PERC Adapter)	3	1
FOXCONN (External Adapter)	3,6	2
External Adapter	3,6,2,4,5,7	6
External Adapter	3,6,2,4,5,7	6
Inventec (LOM Card)	Integrated slot	1
Inventec (LOM Card)	Integrated slot	1
Inventec (Paige Card)	Integrated slot	1
Inventec (Melody Card)	Integrated slot	1
Pensando (SmartNIC: 100Gb)	7	1
IntelSmart (NIC: 100Gb)	7	1
Nvidia (Mellanox) (SmartNIC: 100Gb)	7	1



**Table 101. Config3-2. R1T+R2T+R3B+R4P (FL) (continued)**

<b>Card type</b>	<b>Slot priority</b>	<b>Maximum number of cards</b>
PensandoSmartNIC: 25Gb	7	1
Nvidia (MLNX) (SmartNIC: 25Gb)	7	1
Intel (SmartNIC: 25Gb)	7	1
Mellanox (NIC: 400Gb)	2,7	2
Mellanox (NIC: 400Gb)	3,6	2
Broadcom (NIC: 100Gb)	2,7	2
Broadcom (NIC: 100Gb)	3,6	2
Intel (NIC: 100Gb)	2,4,5,7	4
Intel (NIC: 100Gb)	3,6	2
Mellanox (NIC: 100Gb)	2,7	2
Mellanox (NIC: 100Gb)	3,6	2
Intel (NIC: 25Gb)	2,4,5,7	4
Intel (NIC: 25Gb)	3,6	2
Intel (NIC: 25Gb)	2,7	2
MellanoxNIC: 25Gb	2,7	2
MellanoxNIC: 25Gb	3,6	2
Broadcom (NIC: 25Gb)	2,7	2
Broadcom (NIC: 25Gb)	3,6	2
Broadcom (NIC: 25Gb)	2,4,5,7	4
Broadcom (HBA: FC64)	2,4,5,7	4
Broadcom (HBA: FC64)	3,6	2
Broadcom (HBA: FC32)	2,4,5,7	4
Broadcom (HBA: FC32)	3,6	2
Broadcom (HBA: FC32)	2,4,5,7	4
Broadcom (HBA: FC32)	3,6	2
Broadcom (HBA: FC32)	2,4,5,7	4
Marvell (HBA: FC32)	2,4,5,7	4
Marvell (HBA: FC32)	3,6	2
Marvell (HBA: FC32)	2,4,5,7	4
Marvell (HBA: FC32)	3,6	2
Broadcom (NIC: 10Gb)	2,4,5,7	4
Broadcom (NIC: 10Gb)	3,6	2
Broadcom (NIC: 10Gb)	2,4,5,7	4
Broadcom (NIC: 10Gb)	3,6	2
Intel (NIC: 10Gb)	2,4,5,7	4
Intel (NIC: 10Gb)	3,6	2
Intel (NIC: 10Gb)	2,4,5,7	4

**Table 101. Config3-2. R1T+R2T+R3B+R4P (FL) (continued)**

<b>Card type</b>	<b>Slot priority</b>	<b>Maximum number of cards</b>
Intel (NIC: 10Gb)	3,6	2
Intel (NIC: 1Gb)	3,6	2
Intel (NIC: 1Gb)	2,4,5,7	4
Broadcom (NIC: 1Gb)	2,4,5,7	4
Broadcom (NIC: 1Gb)	3,6	2
Intel (NIC: 1Gb)	3,6	2
Intel (NIC: 1Gb)	2,4,5,7	4
Broadcom (NIC: 1Gb)	2,4,5,7	4
Broadcom (NIC: 1Gb)	3,6	2
Mellanox (NIC: NDR200)	2,7	2
Mellanox (NIC: NDR200)	3,6	2
Mellanox (NIC: HDRV)	2,7	2
Mellanox (NIC: HDRV)	3,6	2
Intel (OCP: 25Gb)	Integrated slot	1
Intel (OCP: 25Gb)	Integrated slot	1
Mellanox (OCP: 25Gb)	Integrated slot	1
Broadcom (OCP: 25Gb)	Integrated slot	1
Broadcom (OCP: 25Gb)	Integrated slot	1
Broadcom (OCP: 25Gb)	Integrated slot	1
Broadcom (OCP: 25Gb)	Integrated slot	1
Broadcom (OCP: 25Gb)	Integrated slot	1
Broadcom (OCP: 10Gb)	Integrated slot	1
Broadcom (OCP: 10Gb)	Integrated slot	1
Intel (OCP: 10Gb)	Integrated slot	1
Intel (OCP: 10Gb)	Integrated slot	1
Broadcom (OCP: 10Gb)	Integrated slot	1
Broadcom (OCP: 1Gb)	Integrated slot	1
Intel (OCP: 1Gb)	Integrated slot	1
Broadcom (OCP: 1Gb)	Integrated slot	1
FOXCONN (BOSS)	Integrated slot	1
FOXCONN (BOSS)	Integrated slot	1

**Table 102. Config4-1. R1T+R2T+R3A+R4P (HL)**

<b>Card type</b>	<b>Slot priority</b>	<b>Maximum number of cards</b>
Nvidia (GPU)	2,5,7	3
Nvidia (GPU)	2,5,7	3
FOXCONN (Front PERC)	Integrated slot	2
FOXCONN (Front PERC)	Integrated slot	2
FOXCONN (Front PERC)	Integrated slot	2

**Table 102. Config4-1. R1T+R2T+R3A+R4P (HL) (continued)**

<b>Card type</b>	<b>Slot priority</b>	<b>Maximum number of cards</b>
FOXCONN (Front PERC)	Integrated slot	1
FOXCONN (Front PERC)	Integrated slot	1
FOXCONN (Front PERC)	Integrated slot	1
FOXCONN (Front PERC)	Integrated slot	1
FOXCONN (External Adapter)	3,6	2
External Adapter	3,6,2,5,7	5
External Adapter	3,6,2,5,7	5
Inventec (LOM Card)	Integrated slot	1
Inventec (LOM Card)	Integrated slot	1
Inventec (Paige Card)	Integrated slot	1
Inventec (Melody Card)	Integrated slot	1
Pensando (SmartNIC: 100Gb)	7	1
IntelSmart (NIC: 100Gb)	7	1
Nvidia (Mellanox) (SmartNIC: 100Gb)	7	1
PensandoSmartNIC: 25Gb	7	1
Nvidia (MLNX) (SmartNIC: 25Gb)	7	1
Intel (SmartNIC: 25Gb)	7	1
Mellanox (NIC: 400Gb)	2,5,7	3
Mellanox (NIC: 400Gb)	3,6	2
Broadcom (NIC: 100Gb)	2,5,7	3
Broadcom (NIC: 100Gb)	3,6	2
Intel (NIC: 100Gb)	2,5,7	3
Intel (NIC: 100Gb)	3,6	2
Mellanox (NIC: 100Gb)	2,5,7	3
Mellanox (NIC: 100Gb)	3,6	2
Intel (NIC: 100Gb)	2,5,7	3
Intel (NIC: 100Gb)	3,6	2
Intel (NIC: 25Gb)	2,5,7	3
Intel (NIC: 25Gb)	3,6	2
Intel (NIC: 25Gb)	2,5,7	3
MellanoxNIC: 25Gb	2,5,7	3
MellanoxNIC: 25Gb	3,6	2
Broadcom (NIC: 25Gb)	2,5,7	3
Broadcom (NIC: 25Gb)	3,6	2
Broadcom (NIC: 25Gb)	2,5,7	3
Broadcom (HBA: FC64)	2,5,7	3
Broadcom (HBA: FC64)	3,6	2

**Table 102. Config4-1. R1T+R2T+R3A+R4P (HL) (continued)**

<b>Card type</b>	<b>Slot priority</b>	<b>Maximum number of cards</b>
Broadcom (HBA: FC32)	2,5,7	3
Broadcom (HBA: FC32)	3,6	2
Broadcom (HBA: FC32)	2,5,7	3
Broadcom (HBA: FC32)	3,6	2
Broadcom (HBA: FC32)	2,5,7	3
Marvell (HBA: FC32)	2,5,7	3
Marvell (HBA: FC32)	3,6	2
Marvell (HBA: FC32)	2,5,7	3
Marvell (HBA: FC32)	3,6	2
Broadcom (NIC: 10Gb)	2,5,7	3
Broadcom (NIC: 10Gb)	3,6	2
Broadcom (NIC: 10Gb)	2,5,7	3
Broadcom (NIC: 10Gb)	3,6	2
Intel (NIC: 10Gb)	2,5,7	3
Intel (NIC: 10Gb)	3,6	2
Intel (NIC: 10Gb)	2,5,7	3
Intel (NIC: 10Gb)	3,6	2
Intel (NIC: 1Gb)	3,6	2
Intel (NIC: 1Gb)	2,5,7	3
Broadcom (NIC: 1Gb)	2,5,7	3
Broadcom (NIC: 1Gb)	3,6	2
Intel (NIC: 1Gb)	3,6	2
Intel (NIC: 1Gb)	2,5,7	3
Broadcom (NIC: 1Gb)	2,5,7	3
Broadcom (NIC: 1Gb)	3,6	2
Mellanox (NIC: NDR200)	2,5,7	3
Mellanox (NIC: NDR200)	3,6	2
Mellanox (NIC: HDRV)	2,5,7	3
Mellanox (NIC: HDRV)	3,6	2
Intel (OCP: 25Gb)	Integrated slot	1
Intel (OCP: 25Gb)	Integrated slot	1
Mellanox (OCP: 25Gb)	Integrated slot	1
Broadcom (OCP: 25Gb)	Integrated slot	1
Broadcom (OCP: 25Gb)	Integrated slot	1
Broadcom (OCP: 25Gb)	Integrated slot	1
Broadcom (OCP: 25Gb)	Integrated slot	1
Broadcom (OCP: 25Gb)	Integrated slot	1
Broadcom (OCP: 10Gb)	Integrated slot	1

**Table 102. Config4-1. R1T+R2T+R3A+R4P (HL) (continued)**

Card type	Slot priority	Maximum number of cards
Broadcom (OCP: 10Gb)	Integrated slot	1
Intel (OCP: 10Gb)	Integrated slot	1
Intel (OCP: 10Gb)	Integrated slot	1
Broadcom (OCP: 10Gb)	Integrated slot	1
Broadcom (OCP: 1Gb)	Integrated slot	1
Intel (OCP: 1Gb)	Integrated slot	1
Broadcom (OCP: 1Gb)	Integrated slot	1
FOXCONN (BOSS)	Integrated slot	1
FOXCONN (BOSS)	Integrated slot	1

**Table 103. Config4-2. R1T+R2T+R3A+R4P (FL)**

Card type	Slot priority	Maximum number of cards
Nvidia (GPU)	2,7,5	3
Nvidia (GPU)	2,7,5	3
Nvidia (GPU)	2,7,5	3
Nvidia (GPU)	2,7,5	3
Nvidia (GPU)	2,7,5	3
AMD (GPU)	2,7,5	3
Nvidia (GPU)	2,5,7	3
Nvidia (GPU)	2,5,7	3
FOXCONN (Front PERC)	Integrated slot	2
FOXCONN (Front PERC)	Integrated slot	2
FOXCONN (Front PERC)	Integrated slot	2
FOXCONN (Front PERC)	Integrated slot	1
FOXCONN (Front PERC)	Integrated slot	1
FOXCONN (Front PERC)	Integrated slot	1
FOXCONN (Front PERC)	Integrated slot	1
FOXCONN (Front PERC)	Integrated slot	1
FOXCONN (External Adapter)	3,6	2
External Adapter	3,6,2,5,7	5
External Adapter	3,6,2,5,7	5
Inventec (LOM Card)	Integrated slot	1
Inventec (LOM Card)	Integrated slot	1
Inventec (Paige Card)	Integrated slot	1
Inventec (Melody Card)	Integrated slot	1
Pensando (SmartNIC: 100Gb)	7	1
IntelSmart (NIC: 100Gb)	7	1
Nvidia (Mellanox) (SmartNIC: 100Gb)	7	1
PensandoSmartNIC: 25Gb	7	1

**Table 103. Config4-2. R1T+R2T+R3A+R4P (FL) (continued)**

<b>Card type</b>	<b>Slot priority</b>	<b>Maximum number of cards</b>
Nvidia (MLNX) (SmartNIC: 25Gb)	7	1
Intel (SmartNIC: 25Gb)	7	1
Mellanox (NIC: 400Gb)	2,5,7	3
Mellanox (NIC: 400Gb)	3,6	2
Broadcom (NIC: 100Gb)	2,5,7	3
Broadcom (NIC: 100Gb)	3,6	2
Intel (NIC: 100Gb)	2,5,7	3
Intel (NIC: 100Gb)	3,6	2
Mellanox (NIC: 100Gb)	2,5,7	3
Mellanox (NIC: 100Gb)	3,6	2
Intel (NIC: 100Gb)	2,5,7	3
Intel (NIC: 100Gb)	3,6	2
Intel (NIC: 25Gb)	2,5,7	3
Intel (NIC: 25Gb)	3,6	2
Intel (NIC: 25Gb)	2,5,7	3
MellanoxNIC: 25Gb	2,5,7	3
MellanoxNIC: 25Gb	3,6	2
Broadcom (NIC: 25Gb)	2,5,7	3
Broadcom (NIC: 25Gb)	3,6	2
Broadcom (NIC: 25Gb)	2,5,7	3
Broadcom (HBA: FC64)	2,5,7	3
Broadcom (HBA: FC64)	3,6	2
Broadcom (HBA: FC32)	2,5,7	3
Broadcom (HBA: FC32)	3,6	2
Broadcom (HBA: FC32)	2,5,7	3
Broadcom (HBA: FC32)	3,6	2
Broadcom (HBA: FC32)	2,5,7	3
Marvell (HBA: FC32)	2,5,7	3
Marvell (HBA: FC32)	3,6	2
Marvell (HBA: FC32)	2,5,7	3
Marvell (HBA: FC32)	3,6	2
Broadcom (NIC: 10Gb)	2,5,7	3
Broadcom (NIC: 10Gb)	3,6	2
Broadcom (NIC: 10Gb)	2,5,7	3
Broadcom (NIC: 10Gb)	3,6	2
Intel (NIC: 10Gb)	2,5,7	3
Intel (NIC: 10Gb)	3,6	2

**Table 103. Config4-2. R1T+R2T+R3A+R4P (FL) (continued)**

Card type	Slot priority	Maximum number of cards
Intel (NIC: 10Gb)	2,5,7	3
Intel (NIC: 10Gb)	3,6	2
Intel (NIC: 1Gb)	3,6	2
Intel (NIC: 1Gb)	2,5,7	3
Broadcom (NIC: 1Gb)	2,5,7	3
Broadcom (NIC: 1Gb)	3,6	2
Intel (NIC: 1Gb)	3,6	2
Intel (NIC: 1Gb)	2,5,7	3
Broadcom (NIC: 1Gb)	2,5,7	3
Broadcom (NIC: 1Gb)	3,6	2
Mellanox (NIC: NDR200)	2,5,7	3
Mellanox (NIC: NDR200)	3,6	2
Mellanox (NIC: HDRV)	2,5,7	3
Mellanox (NIC: HDRV)	3,6	2
Intel (OCP: 25Gb)	Integrated slot	1
Intel (OCP: 25Gb)	Integrated slot	1
Mellanox (OCP: 25Gb)	Integrated slot	1
Broadcom (OCP: 25Gb)	Integrated slot	1
Broadcom (OCP: 25Gb)	Integrated slot	1
Broadcom (OCP: 25Gb)	Integrated slot	1
Broadcom (OCP: 25Gb)	Integrated slot	1
Broadcom (OCP: 25Gb)	Integrated slot	1
Broadcom (OCP: 10Gb)	Integrated slot	1
Broadcom (OCP: 10Gb)	Integrated slot	1
Intel (OCP: 10Gb)	Integrated slot	1
Intel (OCP: 10Gb)	Integrated slot	1
Broadcom (OCP: 10Gb)	Integrated slot	1
Broadcom (OCP: 1Gb)	Integrated slot	1
Intel (OCP: 1Gb)	Integrated slot	1
Broadcom (OCP: 1Gb)	Integrated slot	1
FOXCONN (BOSS)	Integrated slot	1
FOXCONN (BOSS)	Integrated slot	1

**Table 104. Config5-1. R1T+R2T+R3A+R4S (HL)**

Card type	Slot priority	Maximum number of cards
Inventec (2U serial board)	8	1
Nvidia (GPU)	2,5,7,8	4
Nvidia (GPU)	2,5,7,8	4
FOXCONN (Front PERC)	Integrated slot	1

**Table 104. Config5-1. R1T+R2T+R3A+R4S (HL) (continued)**

<b>Card type</b>	<b>Slot priority</b>	<b>Maximum number of cards</b>
FOXCONN (Front PERC)	Integrated slot	1
FOXCONN (Front PERC)	Integrated slot	1
FOXCONN (Front PERC)	Integrated slot	1
FOXCONN (Front PERC)	Integrated slot	1
FOXCONN (Front PERC)	Integrated slot	1
FOXCONN (Front PERC)	Integrated slot	1
FOXCONN (External Adapter)	3,6	2
External Adapter	3,6,2,5,7,8	6
External Adapter	3,6,2,5,7,8	6
Inventec (LOM Card)	Integrated slot	1
Inventec (LOM Card)	Integrated slot	1
Inventec (Paige Card)	Integrated slot	1
Inventec (Melody Card)	Integrated slot	1
Pensando (SmartNIC: 100Gb)	8	1
IntelSmart (NIC: 100Gb)	8	1
Nvidia (Mellanox) (SmartNIC: 100Gb)	8	1
PensandoSmartNIC: 25Gb	8	1
Nvidia (MLNX) (SmartNIC: 25Gb)	8	1
Intel (SmartNIC: 25Gb)	8	1
Mellanox (NIC: 400Gb)	2,5,7,8	4
Mellanox (NIC: 400Gb)	3,6	2
Broadcom (NIC: 100Gb)	2,5,7,8	4
Broadcom (NIC: 100Gb)	3,6	2
Intel (NIC: 100Gb)	2,5,7,8	4
Intel (NIC: 100Gb)	3,6	2
Mellanox (NIC: 100Gb)	2,5,7,8	4
Mellanox (NIC: 100Gb)	3,6	2
Intel (NIC: 100Gb)	2,5,7,8	4
Intel (NIC: 100Gb)	3,6	2
Intel (NIC: 25Gb)	2,5,7,8	4
Intel (NIC: 25Gb)	3,6	2
Intel (NIC: 25Gb)	2,5,7,8	4
MellanoxNIC: 25Gb	2,5,7,8	4
MellanoxNIC: 25Gb	3,6	2
Broadcom (NIC: 25Gb)	2,5,7,8	4
Broadcom (NIC: 25Gb)	3,6	2
Broadcom (NIC: 25Gb)	2,5,7,8	4



**Table 104. Config5-1. R1T+R2T+R3A+R4S (HL) (continued)**

<b>Card type</b>	<b>Slot priority</b>	<b>Maximum number of cards</b>
Broadcom (HBA: FC64)	2,5,7,8	4
Broadcom (HBA: FC64)	3,6	2
Broadcom (HBA: FC32)	2,5,7,8	4
Broadcom (HBA: FC32)	3,6	2
Broadcom (HBA: FC32)	2,5,7,8	4
Broadcom (HBA: FC32)	3,6	2
Broadcom (HBA: FC32)	2,5,7,8	4
Marvell (HBA: FC32)	2,5,7,8	4
Marvell (HBA: FC32)	3,6	2
Marvell (HBA: FC32)	2,5,7,8	4
Marvell (HBA: FC32)	3,6	2
Broadcom (NIC: 10Gb)	2,5,7,8	4
Broadcom (NIC: 10Gb)	3,6	2
Broadcom (NIC: 10Gb)	2,5,7,8	4
Broadcom (NIC: 10Gb)	3,6	2
Intel (NIC: 10Gb)	2,5,7,8	4
Intel (NIC: 10Gb)	3,6	2
Intel (NIC: 10Gb)	2,5,7,8	4
Intel (NIC: 10Gb)	3,6	2
Intel (NIC: 1Gb)	3,6	2
Intel (NIC: 1Gb)	2,5,7,8	4
Broadcom (NIC: 1Gb)	2,5,7,8	4
Broadcom (NIC: 1Gb)	3,6	2
Intel (NIC: 1Gb)	3,6	2
Intel (NIC: 1Gb)	2,5,7,8	4
Broadcom (NIC: 1Gb)	2,5,7,8	4
Broadcom (NIC: 1Gb)	3,6	2
Mellanox (NIC: NDR200)	2,5,7,8	4
Mellanox (NIC: NDR200)	3,6	2
Mellanox (NIC: HDRV)	2,5,7,8	4
Mellanox (NIC: HDRV)	3,6	2
Intel (OCP: 25Gb)	Integrated slot	1
Intel (OCP: 25Gb)	Integrated slot	1
Mellanox (OCP: 25Gb)	Integrated slot	1
Broadcom (OCP: 25Gb)	Integrated slot	1
Broadcom (OCP: 25Gb)	Integrated slot	1
Broadcom (OCP: 25Gb)	Integrated slot	1

**Table 104. Config5-1. R1T+R2T+R3A+R4S (HL) (continued)**

Card type	Slot priority	Maximum number of cards
Broadcom (OCP: 25Gb)	Integrated slot	1
Broadcom (OCP: 10Gb)	Integrated slot	1
Broadcom (OCP: 10Gb)	Integrated slot	1
Intel (OCP: 10Gb)	Integrated slot	1
Intel (OCP: 10Gb)	Integrated slot	1
Broadcom (OCP: 10Gb)	Integrated slot	1
Broadcom (OCP: 1Gb)	Integrated slot	1
Intel (OCP: 1Gb)	Integrated slot	1
Broadcom (OCP: 1Gb)	Integrated slot	1
FOXCONN (BOSS)	Integrated slot	1
FOXCONN (BOSS)	Integrated slot	1

**Table 105. Config5-2. R1T+R2T+R3A+R4S (FL)**

Card type	Slot priority	Maximum number of cards
Inventec (2U serial board)	8	1
Nvidia (GPU)	2,5	2
Nvidia (GPU)	2,5	2
Nvidia (GPU)	2,5	2
Nvidia (GPU)	2,5	2
Nvidia (GPU)	2,5	2
AMD (GPU)	2,5	2
Nvidia (GPU)	2,5,7,8	4
Nvidia (GPU)	2,5,7,8	4
FOXCONN (Front PERC)	Integrated slot	1
FOXCONN (Front PERC)	Integrated slot	1
FOXCONN (Front PERC)	Integrated slot	1
FOXCONN (Front PERC)	Integrated slot	1
FOXCONN (Front PERC)	Integrated slot	1
FOXCONN (Front PERC)	Integrated slot	1
FOXCONN (Front PERC)	Integrated slot	1
FOXCONN (Front PERC)	Integrated slot	1
FOXCONN (External Adapter)	3,6	2
External Adapter	3,6,2,5,7,8	6
External Adapter	3,6,2,5,7,8	6
Inventec (LOM Card)	Integrated slot	1
Inventec (LOM Card)	Integrated slot	1
Inventec (Paige Card)	Integrated slot	1
Inventec (Melody Card)	Integrated slot	1
Pensando (SmartNIC: 100Gb)	8	1

**Table 105. Config5-2. R1T+R2T+R3A+R4S (FL) (continued)**

<b>Card type</b>	<b>Slot priority</b>	<b>Maximum number of cards</b>
IntelSmart (NIC: 100Gb)	8	1
Nvidia (Mellanox) (SmartNIC: 100Gb)	8	1
PensandoSmartNIC: 25Gb	8	1
Nvidia (MLNX) (SmartNIC: 25Gb)	8	1
Intel (SmartNIC: 25Gb)	8	1
Mellanox (NIC: 400Gb)	2,5,7,8	4
Mellanox (NIC: 400Gb)	3,6	2
Broadcom (NIC: 100Gb)	2,5,7,8	4
Broadcom (NIC: 100Gb)	3,6	2
Intel (NIC: 100Gb)	2,5,7,8	4
Intel (NIC: 100Gb)	3,6	2
Mellanox (NIC: 100Gb)	2,5,7,8	4
Mellanox (NIC: 100Gb)	3,6	2
Intel (NIC: 100Gb)	2,5,7,8	4
Intel (NIC: 100Gb)	3,6	2
Intel (NIC: 25Gb)	2,5,7,8	4
Intel (NIC: 25Gb)	3,6	2
Intel (NIC: 25Gb)	2,5,7,8	4
MellanoxNIC: 25Gb	2,5,7,8	4
MellanoxNIC: 25Gb	3,6	2
Broadcom (NIC: 25Gb)	2,5,7,8	4
Broadcom (NIC: 25Gb)	3,6	2
Broadcom (NIC: 25Gb)	2,5,7,8	4
Broadcom (HBA: FC64)	2,5,7,8	4
Broadcom (HBA: FC64)	3,6	2
Broadcom (HBA: FC32)	2,5,7,8	4
Broadcom (HBA: FC32)	3,6	2
Broadcom (HBA: FC32)	2,5,7,8	4
Broadcom (HBA: FC32)	3,6	2
Broadcom (HBA: FC32)	2,5,7,8	4
Marvell (HBA: FC32)	2,5,7,8	4
Marvell (HBA: FC32)	3,6	2
Marvell (HBA: FC32)	2,5,7,8	4
Marvell (HBA: FC32)	3,6	2
Broadcom (NIC: 10Gb)	2,5,7,8	4
Broadcom (NIC: 10Gb)	3,6	2
Broadcom (NIC: 10Gb)	2,5,7,8	4

**Table 105. Config5-2. R1T+R2T+R3A+R4S (FL) (continued)**

Card type	Slot priority	Maximum number of cards
Broadcom (NIC: 10Gb)	3,6	2
Intel (NIC: 10Gb)	2,5,7,8	4
Intel (NIC: 10Gb)	3,6	2
Intel (NIC: 10Gb)	2,5,7,8	4
Intel (NIC: 10Gb)	3,6	2
Intel (NIC: 1Gb)	3,6	2
Intel (NIC: 1Gb)	2,5,7,8	4
Broadcom (NIC: 1Gb)	2,5,7,8	4
Broadcom (NIC: 1Gb)	3,6	2
Intel (NIC: 1Gb)	3,6	2
Intel (NIC: 1Gb)	2,5,7,8	4
Broadcom (NIC: 1Gb)	2,5,7,8	4
Broadcom (NIC: 1Gb)	3,6	2
Mellanox (NIC: NDR200)	2,5,7,8	4
Mellanox (NIC: NDR200)	3,6	2
Mellanox (NIC: HDRV)	2,5,7,8	4
Mellanox (NIC: HDRV)	3,6	2
Intel (OCP: 25Gb)	Integrated slot	1
Intel (OCP: 25Gb)	Integrated slot	1
Mellanox (OCP: 25Gb)	Integrated slot	1
Broadcom (OCP: 25Gb)	Integrated slot	1
Broadcom (OCP: 25Gb)	Integrated slot	1
Broadcom (OCP: 25Gb)	Integrated slot	1
Broadcom (OCP: 25Gb)	Integrated slot	1
Broadcom (OCP: 25Gb)	Integrated slot	1
Broadcom (OCP: 10Gb)	Integrated slot	1
Broadcom (OCP: 10Gb)	Integrated slot	1
Intel (OCP: 10Gb)	Integrated slot	1
Intel (OCP: 10Gb)	Integrated slot	1
Broadcom (OCP: 10Gb)	Integrated slot	1
Broadcom (OCP: 1Gb)	Integrated slot	1
Intel (OCP: 1Gb)	Integrated slot	1
Broadcom (OCP: 1Gb)	Integrated slot	1
FOXCONN (BOSS)	Integrated slot	1
FOXCONN (BOSS)	Integrated slot	1

**Table 106. Config6. R2T+R4Q**

Card type	Slot priority	Maximum number of cards
Inventec (2U serial board)	8	1

**Table 106. Config6. R2T+R4Q (continued)**

<b>Card type</b>	<b>Slot priority</b>	<b>Maximum number of cards</b>
Nvidia (GPU)	7,8	2
Nvidia (GPU)	7,8	2
FOXCONN (Front PERC)	Integrated slot	1
FOXCONN (Front PERC)	Integrated slot	1
FOXCONN (Front PERC)	Integrated slot	1
FOXCONN (Front PERC)	Integrated slot	1
FOXCONN (Front PERC)	Integrated slot	1
FOXCONN PERC Adapter	3	1
FOXCONN (PERC Adapter)	3	1
FOXCONN (PERC Adapter)	3	1
FOXCONN (PERC Adapter)	3	1
FOXCONN (External Adapter)	3,6	2
External Adapter	3,6,7,8	4
External Adapter	3,6,7,8	4
Inventec (LOM Card)	Integrated slot	1
Inventec (LOM Card)	Integrated slot	1
Inventec (Paige Card)	Integrated slot	1
Inventec (Melody Card)	Integrated slot	1
IntelSmart (NIC: 100Gb)	7	1
Nvidia (MLNX) (SmartNIC: 25Gb)	7	1
Intel (SmartNIC: 25Gb)	7	1
Mellanox (NIC: 400Gb)	3,6	2
Broadcom (NIC: 100Gb)	3,6	2
Intel (NIC: 100Gb)	7,8	2
Intel (NIC: 100Gb)	3,6	2
Mellanox (NIC: 100Gb)	3,6	2
Intel (NIC: 100Gb)	3,6	2
Intel (NIC: 25Gb)	7,8	2
Intel (NIC: 25Gb)	3,6	2
MellanoxNIC: 25Gb	3,6	2
Broadcom (NIC: 25Gb)	3,6	2
Broadcom (NIC: 25Gb)	7,8	2
Broadcom (HBA: FC64)	7,8	2
Broadcom (HBA: FC64)	3,6	2
Broadcom (HBA: FC32)	7,8	2
Broadcom (HBA: FC32)	3,6	2
Broadcom (HBA: FC32)	7,8	2

**Table 106. Config6. R2T+R4Q (continued)**

<b>Card type</b>	<b>Slot priority</b>	<b>Maximum number of cards</b>
Broadcom (HBA: FC32)	3,6	2
Broadcom (HBA: FC32)	7,8	2
Marvell (HBA: FC32)	7,8	2
Marvell (HBA: FC32)	3,6	2
Marvell (HBA: FC32)	7,8	2
Marvell (HBA: FC32)	3,6	2
Broadcom (NIC: 10Gb)	7,8	2
Broadcom (NIC: 10Gb)	3,6	2
Broadcom (NIC: 10Gb)	7,8	2
Broadcom (NIC: 10Gb)	3,6	2
Intel (NIC: 10Gb)	7,8	2
Intel (NIC: 10Gb)	3,6	2
Intel (NIC: 10Gb)	7,8	2
Intel (NIC: 10Gb)	3,6	2
Intel (NIC: 1Gb)	3,6	2
Intel (NIC: 1Gb)	7,8	2
Broadcom (NIC: 1Gb)	7,8	2
Broadcom (NIC: 1Gb)	3,6	2
Intel (NIC: 1Gb)	3,6	2
Intel (NIC: 1Gb)	7,8	2
Broadcom (NIC: 1Gb)	7,8	2
Broadcom (NIC: 1Gb)	3,6	2
Mellanox (NIC: NDR200)	3,6	2
Mellanox (NIC: HDRV)	3,6	2
Intel (OCP: 25Gb)	Integrated slot	1
Intel (OCP: 25Gb)	Integrated slot	1
Mellanox (OCP: 25Gb)	Integrated slot	1
Broadcom (OCP: 25Gb)	Integrated slot	1
Broadcom (OCP: 25Gb)	Integrated slot	1
Broadcom (OCP: 25Gb)	Integrated slot	1
Broadcom (OCP: 25Gb)	Integrated slot	1
Broadcom (OCP: 10Gb)	Integrated slot	1
Broadcom (OCP: 10Gb)	Integrated slot	1
Intel (OCP: 10Gb)	Integrated slot	1
Intel (OCP: 10Gb)	Integrated slot	1
Broadcom (OCP: 10Gb)	Integrated slot	1
Broadcom (OCP: 1Gb)	Integrated slot	1

**Table 106. Config6. R2T+R4Q (continued)**

Card type	Slot priority	Maximum number of cards
Intel (OCP: 1Gb)	Integrated slot	1
Broadcom (OCP: 1Gb)	Integrated slot	1
FOXCONN (BOSS)	Integrated slot	1
FOXCONN (BOSS)	Integrated slot	1

**Table 107. Config7. R1U+R2T+R4Q**

Card type	Slot priority	Maximum number of cards
Inventec (2U serial board)	8	1
Nvidia (GPU)	1,2,7,8	4
Nvidia (GPU)	1,2,7,8	4
FOXCONN (Front PERC)	Integrated slot	1
FOXCONN (Front PERC)	Integrated slot	1
FOXCONN (Front PERC)	Integrated slot	1
FOXCONN (Front PERC)	Integrated slot	1
FOXCONN (Front PERC)	Integrated slot	1
FOXCONN PERC Adapter	3	1
FOXCONN (PERC Adapter)	3	1
FOXCONN (PERC Adapter)	3	1
FOXCONN (PERC Adapter)	3	1
FOXCONN (External Adapter)	3,6	2
External Adapter	3,6,1,2,7,8	6
External Adapter	3,6,1,2,7,8	6
Inventec (LOM Card)	Integrated slot	1
Inventec (LOM Card)	Integrated slot	1
Inventec (Paige Card)	Integrated slot	1
Inventec (Melody Card)	Integrated slot	1
IntelSmart (NIC: 100Gb)	7	1
Nvidia (MLNX) (SmartNIC: 25Gb)	7	1
Intel (SmartNIC: 25Gb)	7	1
Mellanox (NIC: 400Gb)	3,6	2
Broadcom (NIC: 100Gb)	3,6	2
Intel (NIC: 100Gb)	1,2,7,8	4
Intel (NIC: 100Gb)	3,6	2
Mellanox (NIC: 100Gb)	3,6	2
Intel (NIC: 100Gb)	3,6	2
Intel (NIC: 25Gb)	1,2,7,8	4
Intel (NIC: 25Gb)	3,6	2
MellanoxNIC: 25Gb	3,6	2

**Table 107. Config7. R1U+R2T+R4Q (continued)**

<b>Card type</b>	<b>Slot priority</b>	<b>Maximum number of cards</b>
Broadcom (NIC: 25Gb)	3,6	2
Broadcom (NIC: 25Gb)	1,2,7,8	4
Broadcom (HBA: FC64)	1,2,7,8	4
Broadcom (HBA: FC64)	3,6	2
Broadcom (HBA: FC32)	1,2,7,8	4
Broadcom (HBA: FC32)	3,6	2
Broadcom (HBA: FC32)	1,2,7,8	4
Broadcom (HBA: FC32)	3,6	2
Broadcom (HBA: FC32)	1,2,7,8	4
Marvell (HBA: FC32)	1,2,7,8	4
Marvell (HBA: FC32)	3,6	2
Marvell (HBA: FC32)	1,2,7,8	4
Marvell (HBA: FC32)	3,6	2
Broadcom (NIC: 10Gb)	1,2,7,8	4
Broadcom (NIC: 10Gb)	3,6	2
Broadcom (NIC: 10Gb)	1,2,7,8	4
Broadcom (NIC: 10Gb)	3,6	2
Intel (NIC: 10Gb)	1,2,7,8	4
Intel (NIC: 10Gb)	3,6	2
Intel (NIC: 10Gb)	1,2,7,8	4
Intel (NIC: 10Gb)	3,6	2
Intel (NIC: 1Gb)	3,6	2
Intel (NIC: 1Gb)	1,2,7,8	4
Broadcom (NIC: 1Gb)	1,2,7,8	4
Broadcom (NIC: 1Gb)	3,6	2
Intel (NIC: 1Gb)	3,6	2
Intel (NIC: 1Gb)	1,2,7,8	4
Broadcom (NIC: 1Gb)	1,2,7,8	4
Broadcom (NIC: 1Gb)	3,6	2
Mellanox (NIC: NDR200)	3,6	2
Mellanox (NIC: HDRV)	3,6	2
Intel (OCP: 25Gb)	Integrated slot	1
Intel (OCP: 25Gb)	Integrated slot	1
Mellanox (OCP: 25Gb)	Integrated slot	1
Broadcom (OCP: 25Gb)	Integrated slot	1
Broadcom (OCP: 25Gb)	Integrated slot	1
Broadcom (OCP: 25Gb)	Integrated slot	1



**Table 107. Config7. R1U+R2T+R4Q (continued)**

Card type	Slot priority	Maximum number of cards
Broadcom (OCP: 25Gb)	Integrated slot	1
Broadcom (OCP: 10Gb)	Integrated slot	1
Broadcom (OCP: 10Gb)	Integrated slot	1
Intel (OCP: 10Gb)	Integrated slot	1
Intel (OCP: 10Gb)	Integrated slot	1
Broadcom (OCP: 10Gb)	Integrated slot	1
Broadcom (OCP: 1Gb)	Integrated slot	1
Intel (OCP: 1Gb)	Integrated slot	1
Broadcom (OCP: 1Gb)	Integrated slot	1
FOXCONN (BOSS)	Integrated slot	1
FOXCONN (BOSS)	Integrated slot	1

**Table 108. Config8. R2A+R4A (HL)**

Card type	Slot priority	Maximum number of cards
Nvidia (GPU)	7	1
Nvidia (GPU)	7	1
FOXCONN (Front PERC)	Integrated slot	1
FOXCONN (Front PERC)	Integrated slot	1
FOXCONN (PERC Adapter)	3	1
FOXCONN (PERC Adapter)	3	1
FOXCONN (PERC Adapter)	3	1
FOXCONN (External Adapter)	3,6	2
External Adapter	3,6,7	3
External Adapter	3,6,7	3
Inventec (LOM Card)	Integrated slot	1
Inventec (LOM Card)	Integrated slot	1
Mellanox (NIC: 400Gb)	7	1
Broadcom (NIC: 100Gb)	7	1
Intel (NIC: 100Gb)	7	1
Intel (NIC: 100Gb)	3,6	2
Mellanox (NIC: 100Gb)	7	1
Intel (NIC: 100Gb)	7	1
Intel (NIC: 25Gb)	7	1
Intel (NIC: 25Gb)	3,6	2
Intel (NIC: 25Gb)	7	1
MellanoxNIC: 25Gb	7	1
Broadcom (NIC: 25Gb)	7	1
Broadcom (NIC: 25Gb)	3,6	2

**Table 108. Config8. R2A+R4A (HL) (continued)**

<b>Card type</b>	<b>Slot priority</b>	<b>Maximum number of cards</b>
Broadcom (NIC: 25Gb)	7	1
Broadcom (HBA: FC64)	7	1
Broadcom (HBA: FC64)	3,6	2
Broadcom (HBA: FC32)	7	1
Broadcom (HBA: FC32)	3,6	2
Broadcom (HBA: FC32)	7	1
Broadcom (HBA: FC32)	3,6	2
Broadcom (HBA: FC32)	7	1
Marvell (HBA: FC32)	7	1
Marvell (HBA: FC32)	3,6	2
Marvell (HBA: FC32)	7	1
Marvell (HBA: FC32)	3,6	2
Broadcom (NIC: 10Gb)	7	1
Broadcom (NIC: 10Gb)	3,6	2
Broadcom (NIC: 10Gb)	7	1
Broadcom (NIC: 10Gb)	3,6	2
Intel (NIC: 10Gb)	7	1
Intel (NIC: 10Gb)	3,6	2
Intel (NIC: 10Gb)	7	1
Intel (NIC: 10Gb)	3,6	2
Intel (NIC: 1Gb)	3,6	2
Intel (NIC: 1Gb)	7	1
Broadcom (NIC: 1Gb)	7	1
Broadcom (NIC: 1Gb)	3,6	2
Intel (NIC: 1Gb)	3,6	2
Intel (NIC: 1Gb)	7	1
Broadcom (NIC: 1Gb)	7	1
Broadcom (NIC: 1Gb)	3,6	2
Mellanox (NIC: NDR200)	7	1
Mellanox (NIC: HDRV)	7	1
Intel (OCP: 25Gb)	Integrated slot	1
Intel (OCP: 25Gb)	Integrated slot	1
Mellanox (OCP: 25Gb)	Integrated slot	1
Broadcom (OCP: 25Gb)	Integrated slot	1
Broadcom (OCP: 25Gb)	Integrated slot	1
Broadcom (OCP: 25Gb)	Integrated slot	1
Broadcom (OCP: 25Gb)	Integrated slot	1

**Table 108. Config8. R2A+R4A (HL) (continued)**

Card type	Slot priority	Maximum number of cards
Broadcom (OCP: 10Gb)	Integrated slot	1
Broadcom (OCP: 10Gb)	Integrated slot	1
Intel (OCP: 10Gb)	Integrated slot	1
Intel (OCP: 10Gb)	Integrated slot	1
Broadcom (OCP: 10Gb)	Integrated slot	1
Broadcom (OCP: 1Gb)	Integrated slot	1
Intel (OCP: 1Gb)	Integrated slot	1
Broadcom (OCP: 1Gb)	Integrated slot	1
FOXCONN (BOSS)	Integrated slot	1
FOXCONN (BOSS)	Integrated slot	1

**Table 109. Config9. R2A+R3A+R4P (HL)**

Card type	Slot priority	Maximum number of cards
Nvidia (GPU)	5,7	2
Nvidia (GPU)	5,7	2
FOXCONN (Front PERC)	Integrated slot	1
FOXCONN (Front PERC)	Integrated slot	1
FOXCONN (Front PERC)	Integrated slot	1
FOXCONN (Front PERC)	Integrated slot	1
FOXCONN (Front PERC)	Integrated slot	1
FOXCONN (PERC Adapter)	3	1
FOXCONN (PERC Adapter)	3	1
FOXCONN (PERC Adapter)	3	1
FOXCONN (External Adapter)	3,6	2
External Adapter	3,6,5,7	4
External Adapter	3,6,5,7	4
Inventec (LOM Card)	Integrated slot	1
Inventec (LOM Card)	Integrated slot	1
Inventec (Paige Card)	Integrated slot	1
Inventec (Melody Card)	Integrated slot	1
Pensando (SmartNIC: 100Gb)	7	1
IntelSmart (NIC: 100Gb)	7	1
Nvidia (Mellanox) (SmartNIC: 100Gb)	7	1
PensandoSmartNIC: 25Gb	7	1
Nvidia (MLNX) (SmartNIC: 25Gb)	7	1
Intel (SmartNIC: 25Gb)	7	1
Mellanox (NIC: 400Gb)	5,7	2
Broadcom (NIC: 100Gb)	5,7	2

**Table 109. Config9. R2A+R3A+R4P (HL) (continued)**

<b>Card type</b>	<b>Slot priority</b>	<b>Maximum number of cards</b>
Intel (NIC: 100Gb)	5,7	2
Intel (NIC: 100Gb)	3,6	2
Mellanox (NIC: 100Gb)	5,7	2
Intel (NIC: 100Gb)	5,7	2
Intel (NIC: 25Gb)	5,7	2
Intel (NIC: 25Gb)	3,6	2
Intel (NIC: 25Gb)	5,7	2
MellanoxNIC: 25Gb	5,7	2
Broadcom (NIC: 25Gb)	5,7	2
Broadcom (NIC: 25Gb)	3,6	2
Broadcom (NIC: 25Gb)	5,7	2
Broadcom (HBA: FC64)	5,7	2
Broadcom (HBA: FC64)	3,6	2
Broadcom (HBA: FC32)	5,7	2
Broadcom (HBA: FC32)	3,6	2
Broadcom (HBA: FC32)	5,7	2
Broadcom (HBA: FC32)	3,6	2
Broadcom (HBA: FC32)	5,7	2
Marvell (HBA: FC32)	5,7	2
Marvell (HBA: FC32)	3,6	2
Marvell (HBA: FC32)	5,7	2
Marvell (HBA: FC32)	3,6	2
Broadcom (NIC: 10Gb)	5,7	2
Broadcom (NIC: 10Gb)	3,6	2
Broadcom (NIC: 10Gb)	5,7	2
Broadcom (NIC: 10Gb)	3,6	2
Intel (NIC: 10Gb)	5,7	2
Intel (NIC: 10Gb)	3,6	2
Intel (NIC: 10Gb)	5,7	2
Intel (NIC: 10Gb)	3,6	2
Intel (NIC: 1Gb)	3,6	2
Intel (NIC: 1Gb)	5,7	2
Broadcom (NIC: 1Gb)	5,7	2
Broadcom (NIC: 1Gb)	3,6	2
Intel (NIC: 1Gb)	3,6	2
Intel (NIC: 1Gb)	5,7	2
Broadcom (NIC: 1Gb)	5,7	2

**Table 109. Config9. R2A+R3A+R4P (HL) (continued)**

Card type	Slot priority	Maximum number of cards
Broadcom (NIC: 1Gb)	3,6	2
Mellanox (NIC: NDR200)	5,7	2
Mellanox (NIC: HDRV)	5,7	2
Intel (OCP: 25Gb)	Integrated slot	1
Intel (OCP: 25Gb)	Integrated slot	1
Mellanox (OCP: 25Gb)	Integrated slot	1
Broadcom (OCP: 25Gb)	Integrated slot	1
Broadcom (OCP: 25Gb)	Integrated slot	1
Broadcom (OCP: 25Gb)	Integrated slot	1
Broadcom (OCP: 25Gb)	Integrated slot	1
Broadcom (OCP: 10Gb)	Integrated slot	1
Broadcom (OCP: 10Gb)	Integrated slot	1
Intel (OCP: 10Gb)	Integrated slot	1
Intel (OCP: 10Gb)	Integrated slot	1
Broadcom (OCP: 10Gb)	Integrated slot	1
Broadcom (OCP: 1Gb)	Integrated slot	1
Intel (OCP: 1Gb)	Integrated slot	1
Broadcom (OCP: 1Gb)	Integrated slot	1
FOXCONN (BOSS)	Integrated slot	1
FOXCONN (BOSS)	Integrated slot	1

**Table 110. Config10. R1U+R3B+R4Q**

Card type	Slot priority	Maximum number of cards
Inventec (2U serial board)	8	1
Nvidia (GPU)	1,2,4,5,7,8	6
Nvidia (GPU)	1,2,4,5,7,8	6
FOXCONN (Front PERC)	Integrated slot	2
FOXCONN (Front PERC)	Integrated slot	2
FOXCONN (Front PERC)	Integrated slot	2
FOXCONN (Front PERC)	Integrated slot	1
FOXCONN (Front PERC)	Integrated slot	1
FOXCONN (Front PERC)	Integrated slot	1
FOXCONN (Front PERC)	Integrated slot	1
External Adapter	1,2,4,5,7,8	6
External Adapter	1,2,4,5,7,8	6
Inventec (LOM Card)	Integrated slot	1
Inventec (LOM Card)	Integrated slot	1
Inventec (Paige Card)	Integrated slot	1

**Table 110. Config10. R1U+R3B+R4Q (continued)**


<b>Card type</b>	<b>Slot priority</b>	<b>Maximum number of cards</b>
Inventec (Melody Card)	Integrated slot	1
IntelSmart (NIC: 100Gb)	7	1
Nvidia (MLNX) (SmartNIC: 25Gb)	7	1
Intel (SmartNIC: 25Gb)	7	1
Intel (NIC: 100Gb)	1,2,4,5,7,8	6
Intel (NIC: 25Gb)	1,2,4,5,7,8	6
Broadcom (NIC: 25Gb)	1,2,4,5,7,8	6
Broadcom (HBA: FC64)	1,2,4,5,7,8	6
Broadcom (HBA: FC32)	1,2,4,5,7,8	6
Broadcom (HBA: FC32)	1,2,4,5,7,8	6
Broadcom (HBA: FC32)	1,2,4,5,7,8	6
Marvell (HBA: FC32)	1,2,4,5,7,8	6
Marvell (HBA: FC32)	1,2,4,5,7,8	6
Broadcom (NIC: 10Gb)	1,2,4,5,7,8	6
Broadcom (NIC: 10Gb)	1,2,4,5,7,8	6
Intel (NIC: 10Gb)	1,2,4,5,7,8	6
Intel (NIC: 10Gb)	1,2,4,5,7,8	6
Intel (NIC: 1Gb)	1,2,4,5,7,8	6
Broadcom (NIC: 1Gb)	1,2,4,5,7,8	6
Intel (NIC: 1Gb)	1,2,4,5,7,8	6
Broadcom (NIC: 1Gb)	1,2,4,5,7,8	6
Intel (OCP: 25Gb)	Integrated slot	1
Intel (OCP: 25Gb)	Integrated slot	1
Mellanox (OCP: 25Gb)	Integrated slot	1
Broadcom (OCP: 25Gb)	Integrated slot	1
Broadcom (OCP: 25Gb)	Integrated slot	1
Broadcom (OCP: 25Gb)	Integrated slot	1
Broadcom (OCP: 25Gb)	Integrated slot	1
Broadcom (OCP: 10Gb)	Integrated slot	1
Broadcom (OCP: 10Gb)	Integrated slot	1
Intel (OCP: 10Gb)	Integrated slot	1
Intel (OCP: 10Gb)	Integrated slot	1
Broadcom (OCP: 10Gb)	Integrated slot	1
Broadcom (OCP: 1Gb)	Integrated slot	1
Intel (OCP: 1Gb)	Integrated slot	1
Broadcom (OCP: 1Gb)	Integrated slot	1
FOXCONN (BOSS)	Integrated slot	1

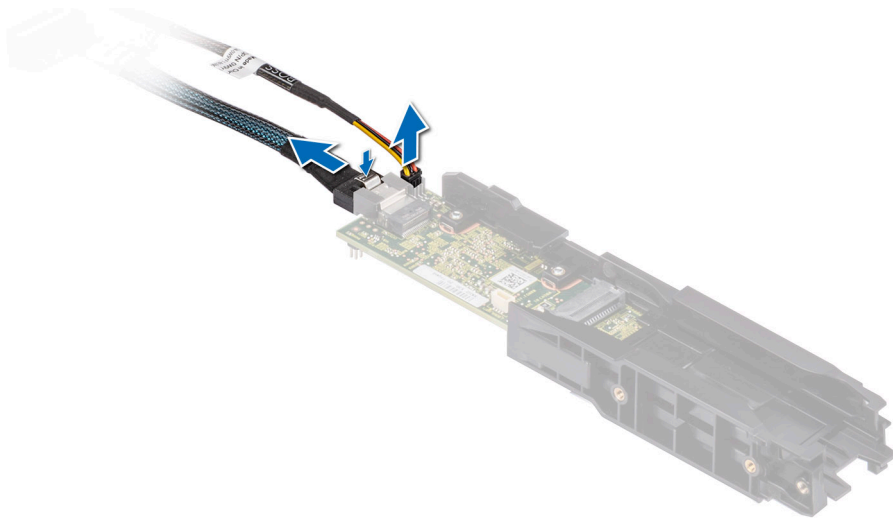
**Table 110. Config10. R1U+R3B+R4Q (continued)**

Card type	Slot priority	Maximum number of cards
FOXCONN (BOSS)	Integrated slot	1

## Removing the expansion card risers

### Prerequisites

1. Follow the safety guidelines listed in the [Safety instructions](#).
2. Follow the procedure listed in the [Before working inside your system](#).
3. [Remove the air shroud](#) or [remove the GPU air shroud](#).
4.  **NOTE:** If BOSS-N1 module is installed, ensure to disconnect the BOSS-N1 power cable and Signal cable before removing the Riser 1 cage.



5. If applicable, disconnect the cables from the expansion card or system board.

### Steps

1. Loosen the captive screws on the riser and system.
2. Press the blue release tab or blue button on the riser and holding the edges lift the expansion card riser from the riser connector on the system board.

 **NOTE:** The numbers on the image do not depict the exact steps. The numbers are for representation of sequence.

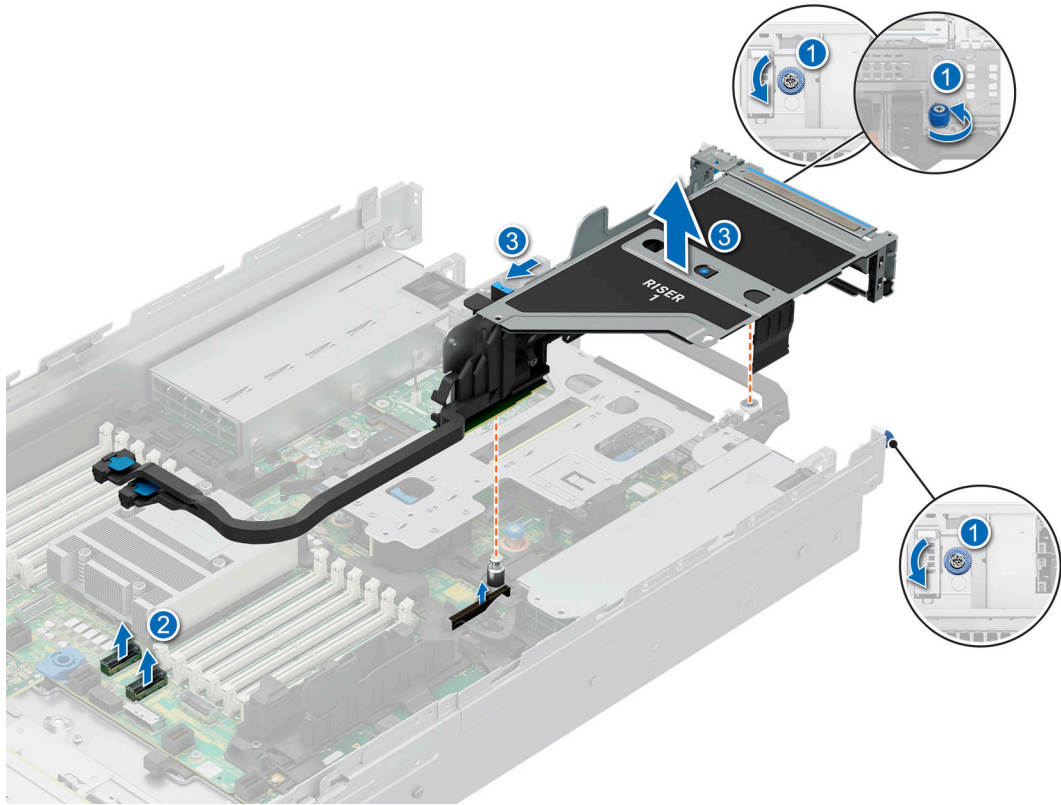


Figure 135. Removing the expansion card riser 1

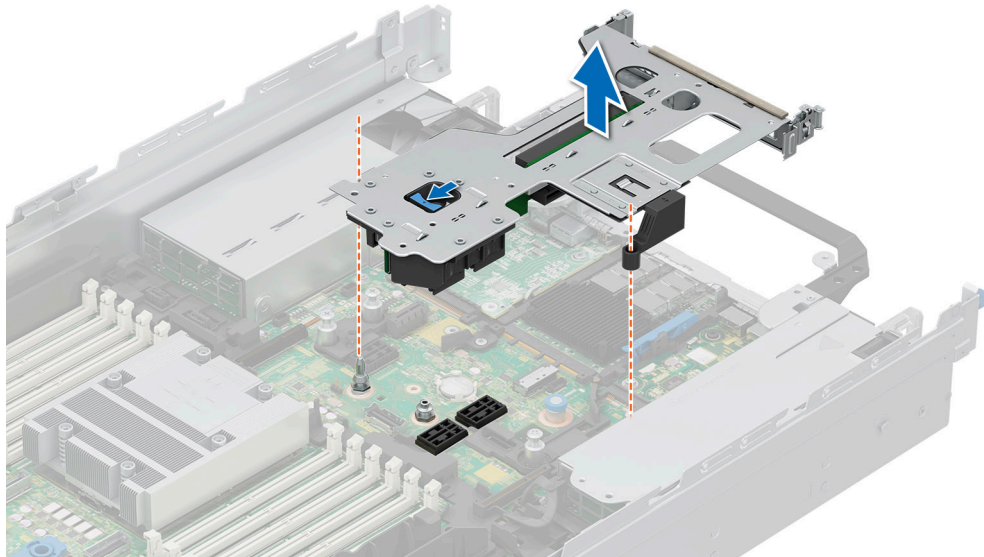


Figure 136. Removing the expansion card riser 2



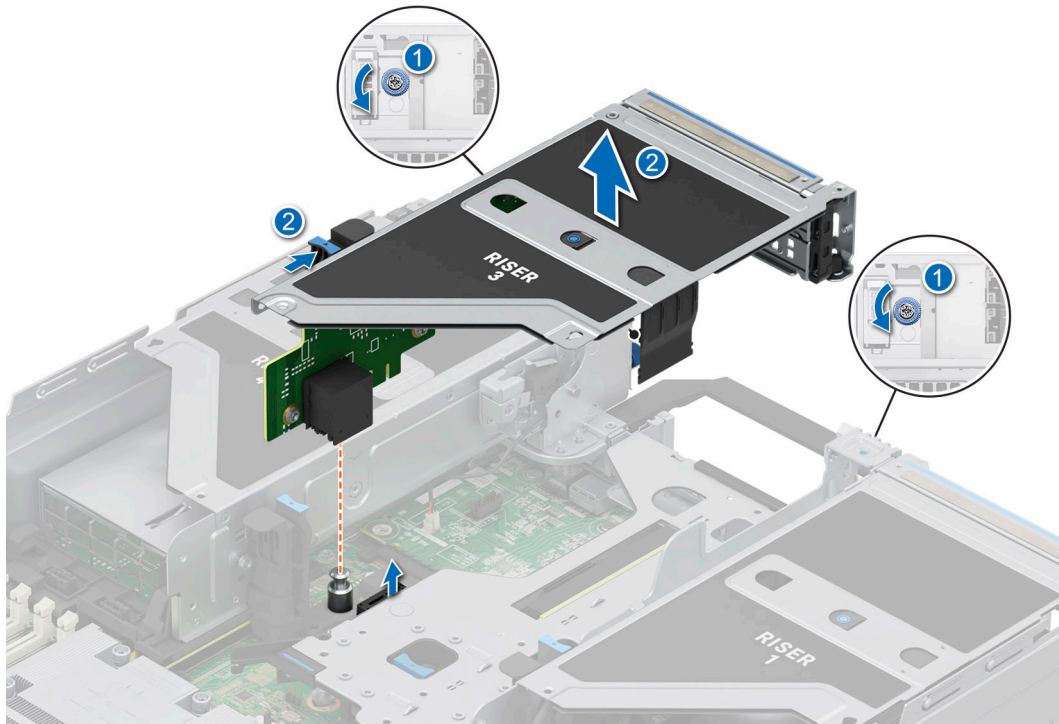


Figure 137. Removing the expansion card riser 3

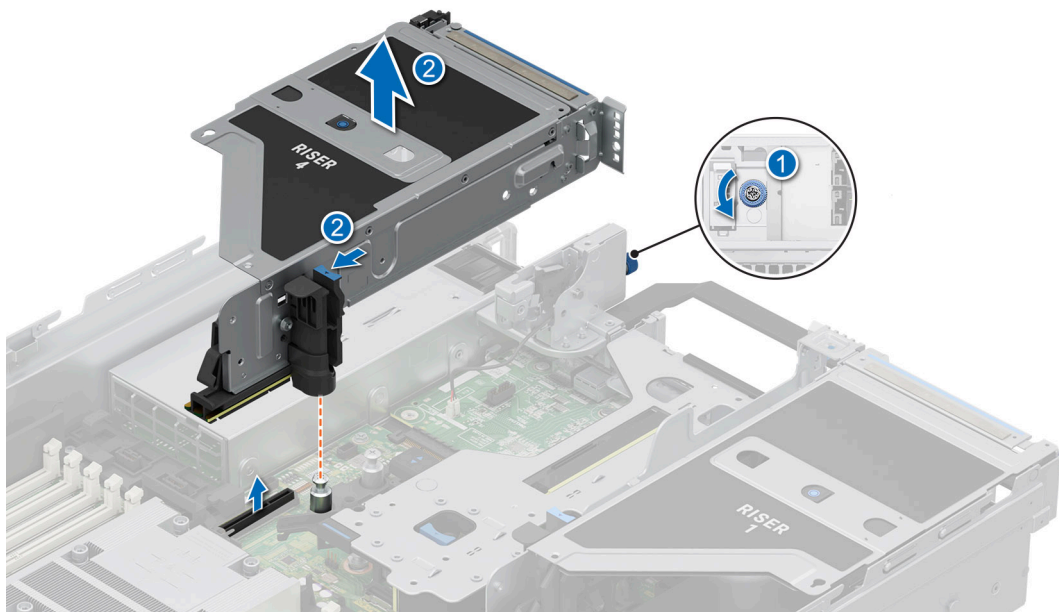
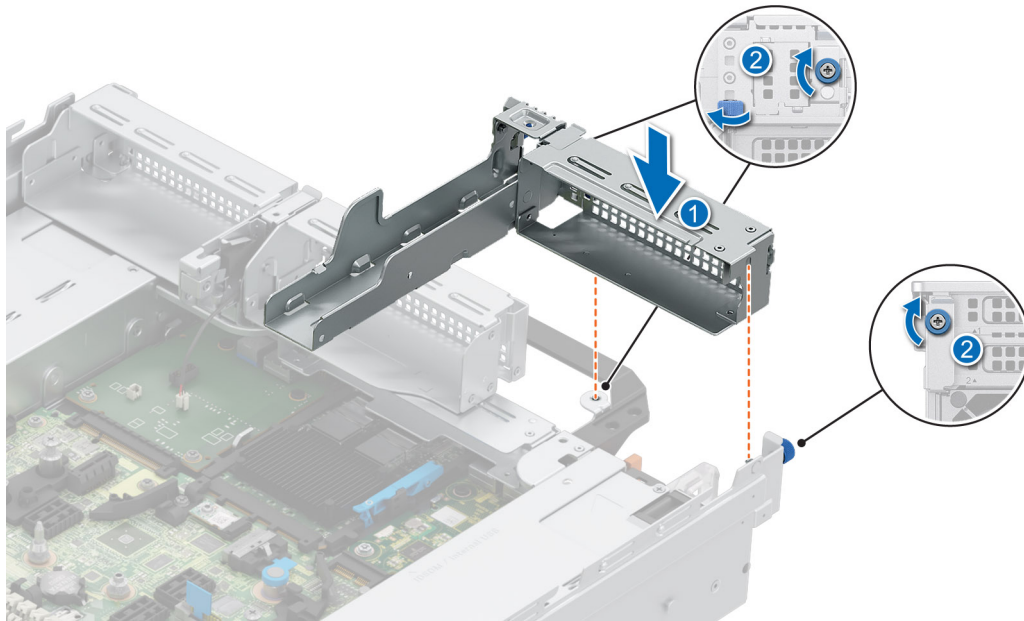


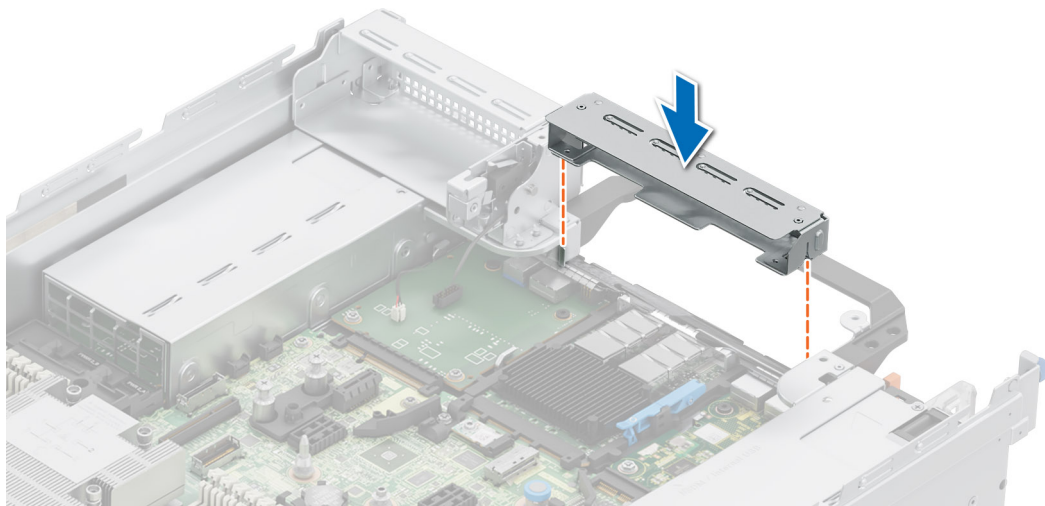
Figure 138. Removing the expansion card riser 4

3. If the risers are not going to be replaced, install riser blanks, and if required tighten the captive screws.

**i NOTE:** You must install a filler bracket over an empty expansion card slot to maintain Federal Communications Commission (FCC) certification of the system. The brackets also keep dust and dirt out of the system and aid in proper cooling and airflow inside the system.



**Figure 139. Installing the Riser 1 blank**



**Figure 140. Installing the Riser 2 blank**

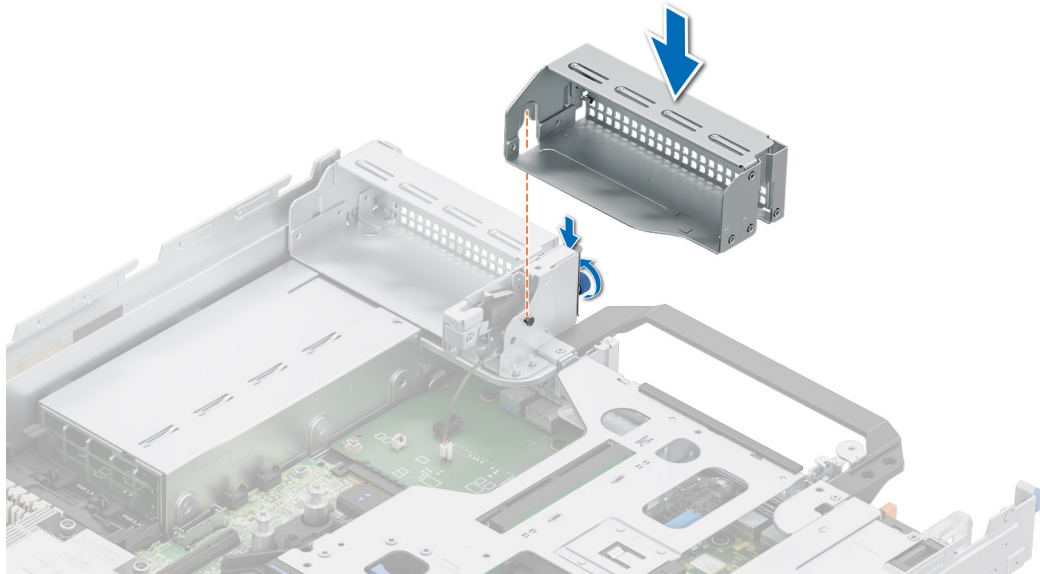


Figure 141. Installing the Riser 3 blank

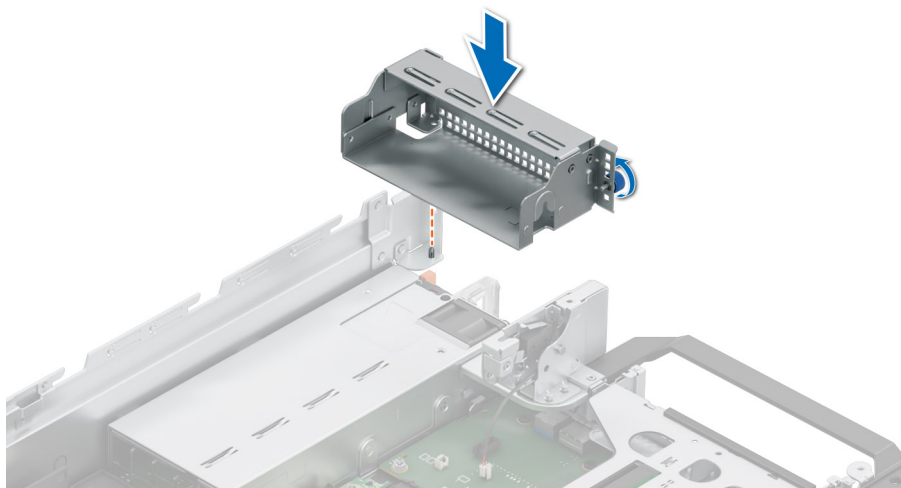


Figure 142. Installing the Riser 4 blank

### Next steps

1. [Replace the expansion card riser.](#)

## Installing the expansion card risers

### Prerequisites

1. Follow the safety guidelines listed in the [Safety instructions](#).
2. Follow the procedure listed in [Before working inside your system](#).
3. [Remove the air shroud](#) or [remove the GPU air shroud](#).
4. If removed, [install the expansion cards into the expansion card risers](#).

**i** **NOTE:** Install Riser 2 before installing Riser 1 and Riser 3. Install Riser 4 after installing Riser 3.

**⚠ CAUTION:** Do not install GPUs, network cards, or other PCIe devices on your system that are not validated and tested by Dell. Damage caused by unauthorized and invalidated hardware installation will null and void the system warranty.

## Steps

1. If installed, remove the riser blanks and if required loosen the captive screws.

**i** **NOTE:** Store the riser blanks for future use. Filler brackets must be installed in empty expansion card slots to maintain Federal Communications Commission (FCC) certification of the system. The brackets also keep dust and dirt out of the system and aid in proper cooling and airflow inside the system.

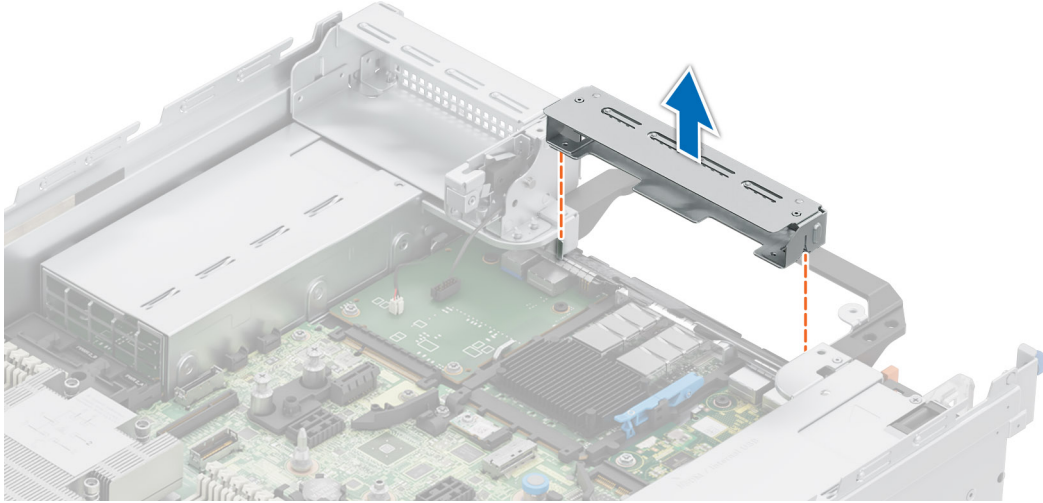


Figure 143. Removing the Riser 2 blank

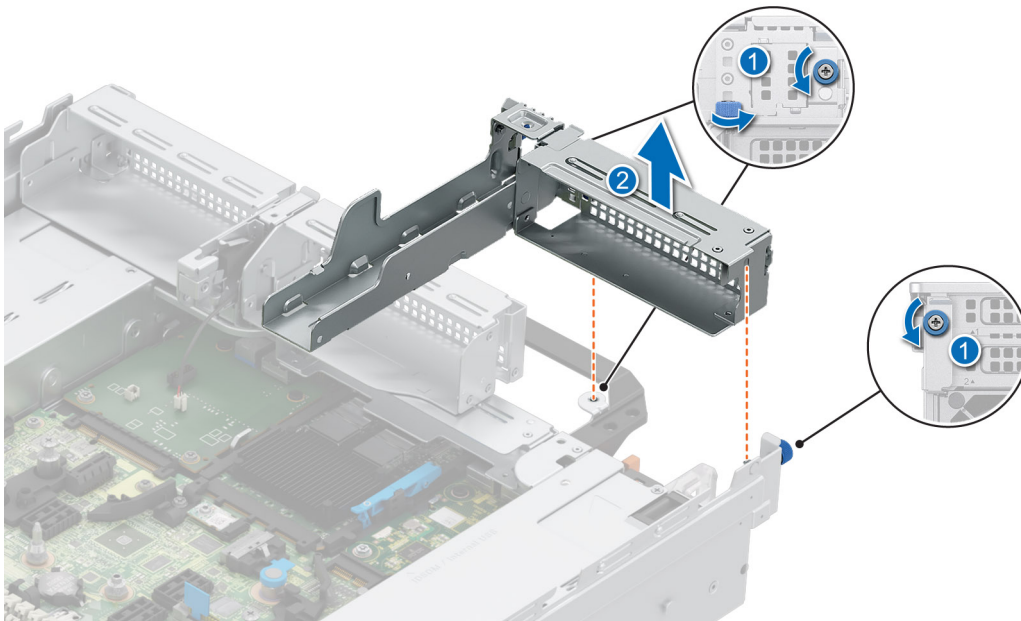
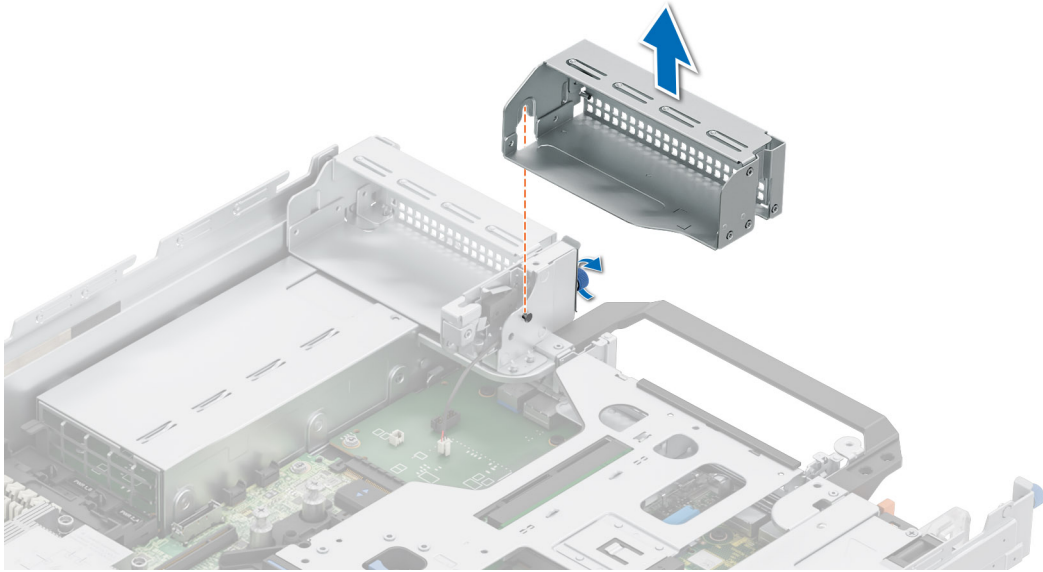
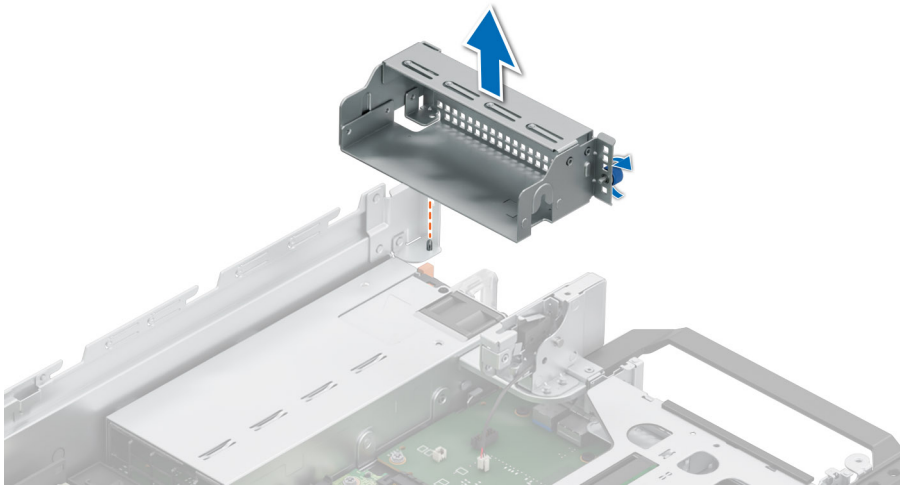


Figure 144. Removing the Riser 1 blank



**Figure 145. Removing the Riser 3 blank**



**Figure 146. Removing the Riser 4 blank**

2. Holding the edges or the touch points, align the holes on the expansion card riser with the guides on the system board.
3. Lower the expansion card riser into place and press the touch points until the expansion card riser connector is fully seated on the system board connector.
4. Tighten the captive screws on the risers and system if any.

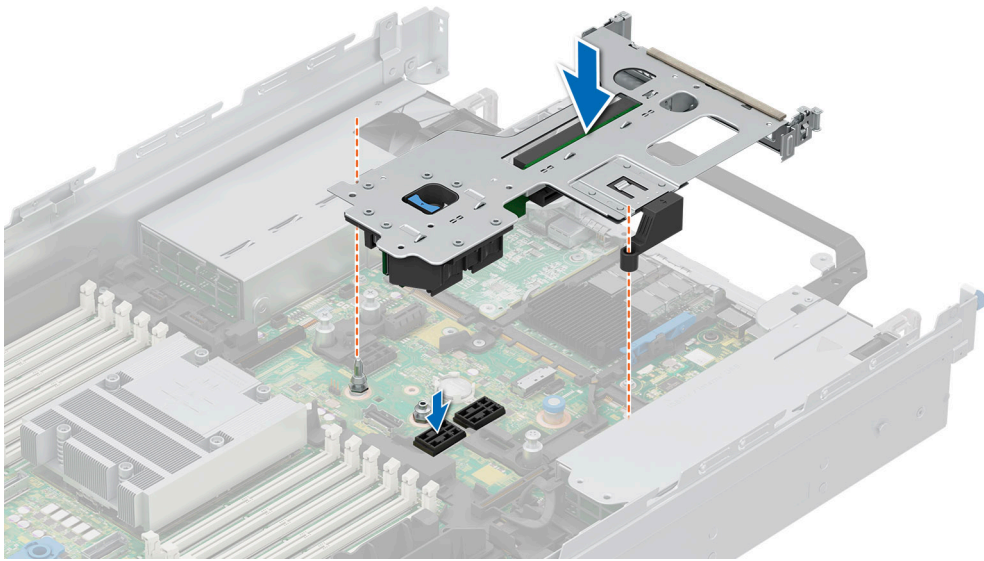


Figure 147. Installing the expansion card riser 2

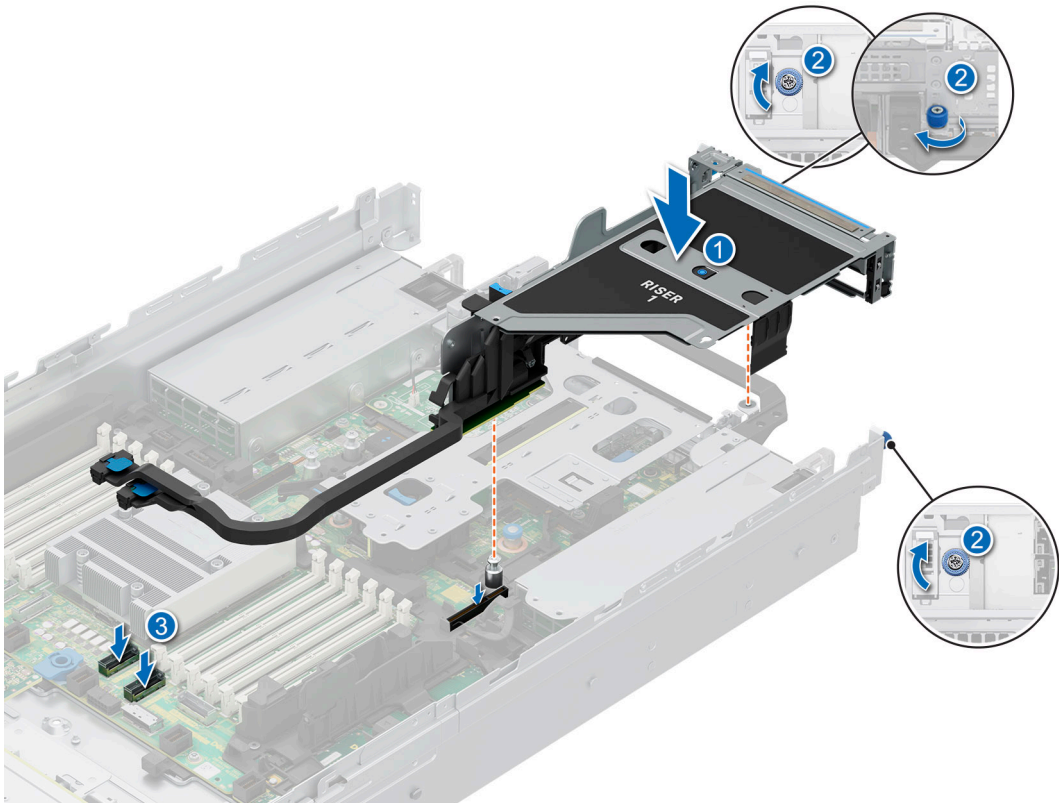


Figure 148. Installing the expansion card riser 1

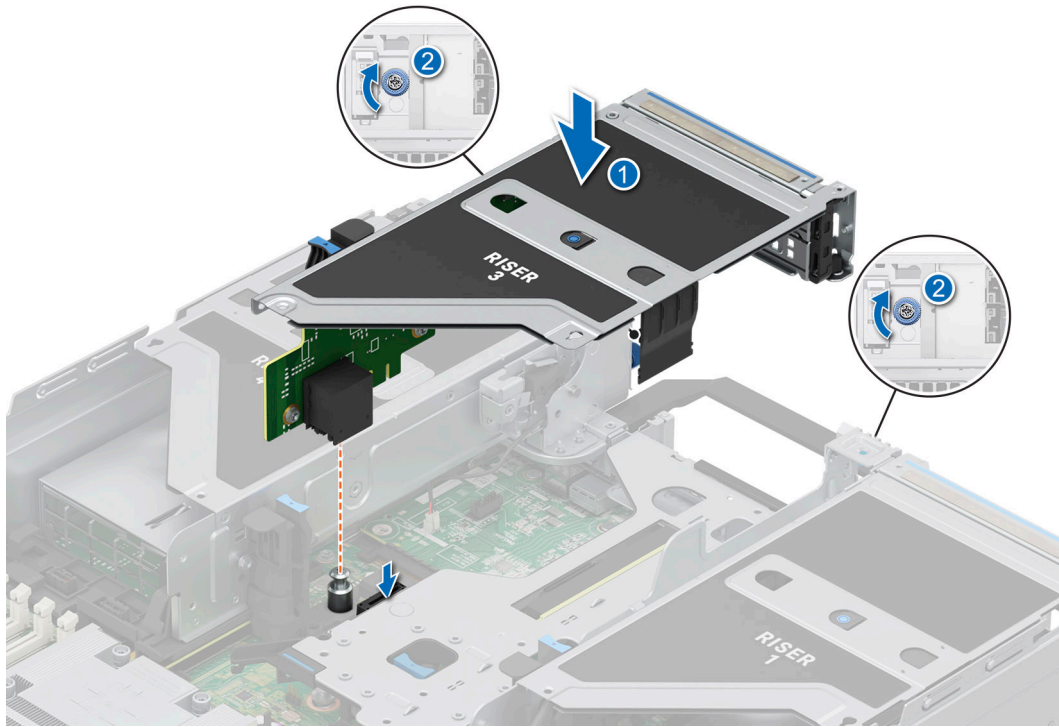


Figure 149. Installing the expansion card riser 3

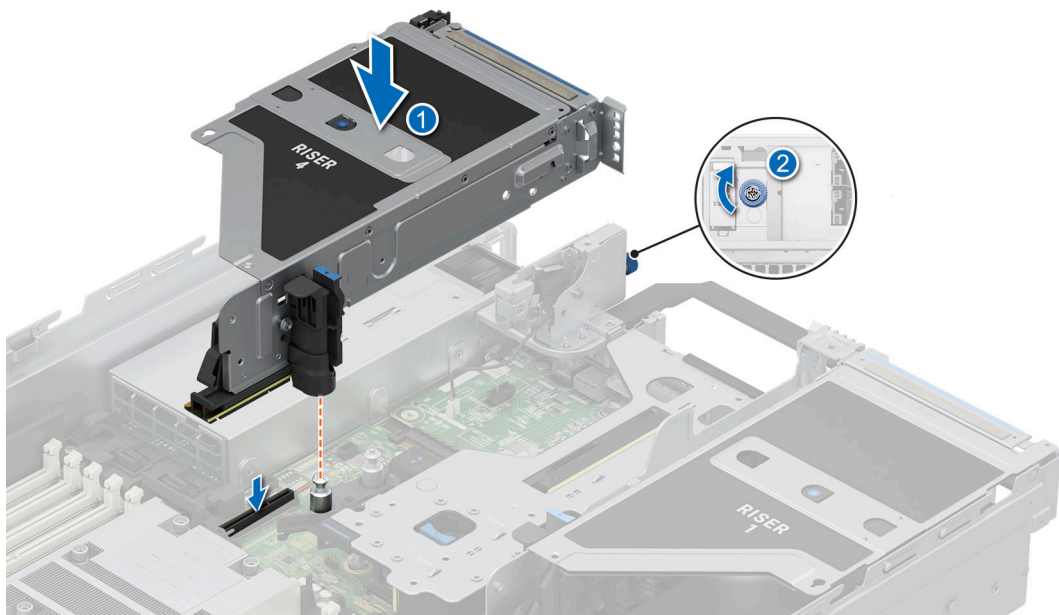


Figure 150. Installing the expansion card riser 4

#### Next steps

1. If required, reconnect the cables to the expansion card or system board.
2. [Install the air shroud](#) or [install the GPU air shroud](#).
3. Follow the procedure listed in [After working inside your system](#).
4. Install any device drivers required for the card as described in the documentation for the card.


# Removing expansion card from the expansion card riser

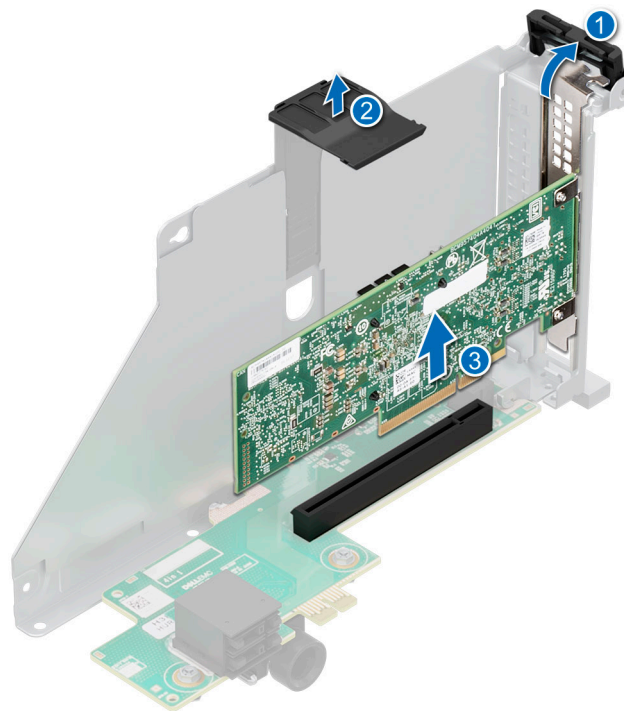
## Prerequisites

1. Follow the safety guidelines listed in the [Safety instructions](#).
2. Follow the procedure listed in the [Before working inside your system](#).
3. If applicable, disconnect the cables from the expansion card.
4. [Remove the air shroud](#) or [remove the GPU air shroud](#).
5. [Remove the expansion card riser](#).

## Steps

1. Tilt the expansion card retention latch lock to open.
2. Pull the card holder before removing the card from the riser.
3. Hold the expansion card by the edges and pull the card from the riser.

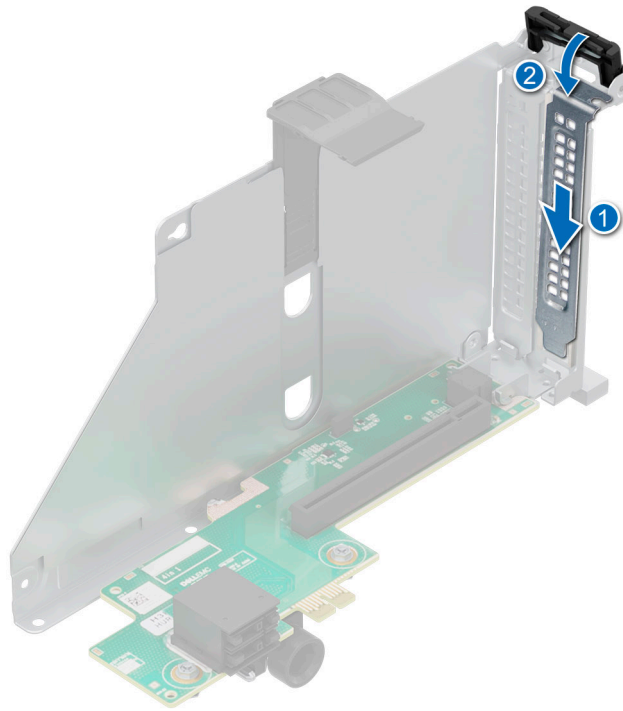
 **NOTE:** The numbers on the image do not depict the exact steps. The numbers are for representation of sequence.



**Figure 151. Removing expansion card from the expansion card riser**

4. If the expansion card is not going to be replaced, install a filler bracket and close the card retention latch.





**Figure 152. Installing the filler bracket**

#### Next steps

1. If applicable, [install an expansion card into the expansion card riser](#).

## Installing an expansion card into the expansion card riser

#### Prerequisites

1. Follow the safety guidelines listed in the [Safety instructions](#).
2. Follow the procedure listed in [Before working inside your system](#).
3. [Remove the air shroud](#) or [remove the GPU air shroud](#).
4. [Remove the expansion card riser](#).
5. If installing a new expansion card, unpack it and prepare the card for installation.

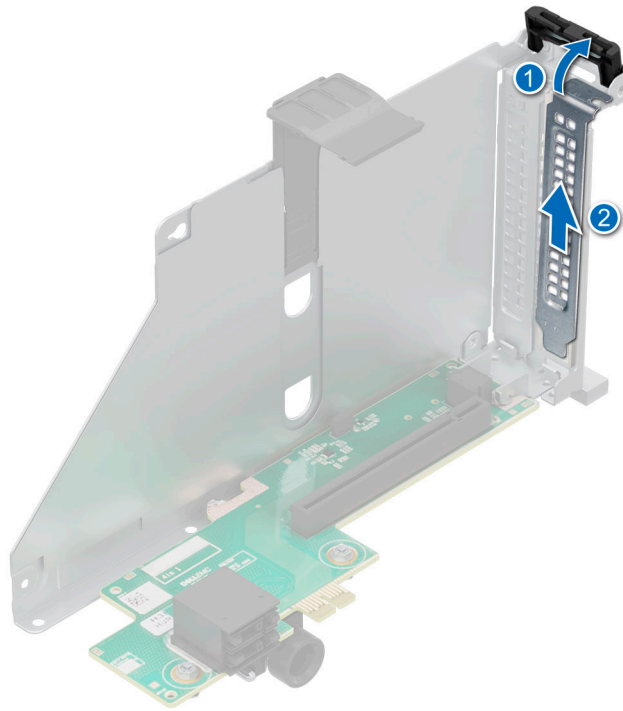
**i** **NOTE:** For instructions, see the documentation accompanying the card.

**⚠ CAUTION:** Do not install GPUs, network cards, or other PCIe devices on your system that are not validated and tested by Dell. Damage caused by unauthorized and invalidated hardware installation will null and void the system warranty.

#### Steps

1. Tilt the expansion card retention latch lock to open.
2. If installed, remove the filler bracket.

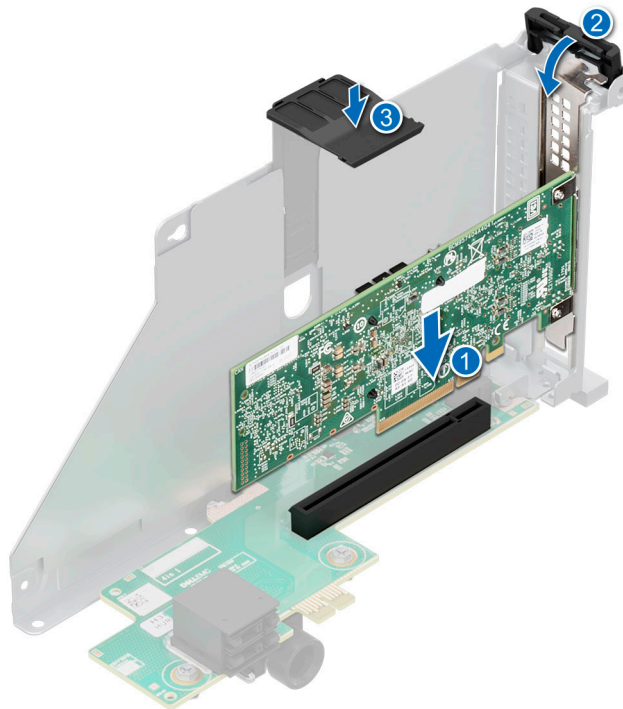
**i** **NOTE:** Store the filler bracket for future use. Filler brackets must be installed in empty expansion card slots to maintain Federal Communications Commission (FCC) certification of the system. The brackets also keep dust and dirt out of the system and aid in proper cooling and airflow inside the system.



**Figure 153. Removing the filler bracket**

3. Hold the card by edges, and align the card with the connector on the riser.
4. Insert the card firmly into the expansion card connector until seated.
5. Close the expansion card retention latch.
6. Push the card holder to hold the card in the riser.

**NOTE:** The numbers on the image do not depict the exact steps. The numbers are for representation of sequence.




**Figure 154. Installing an expansion card into the expansion card riser**

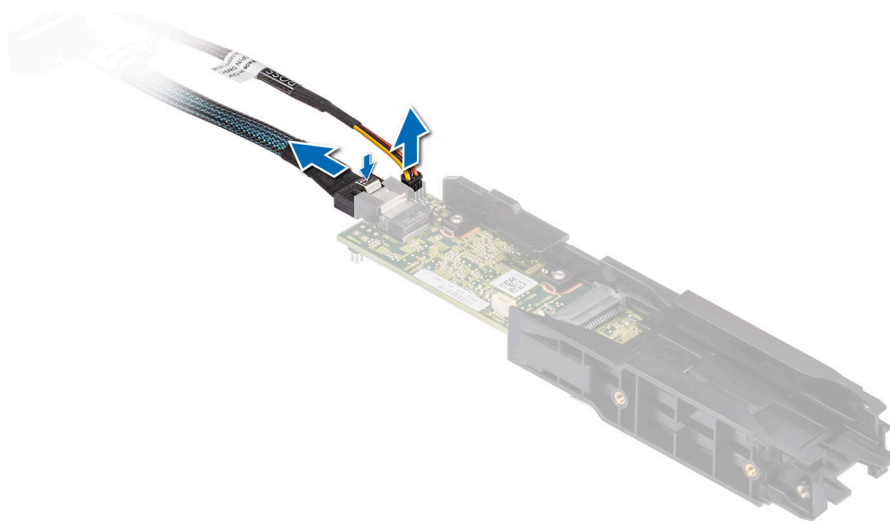
### Next steps

1. If applicable, connect the cables to the expansion card.
2. [Install the expansion card risers.](#)
3. [Install the air shroud](#) or [install the GPU air shroud.](#)
4. Follow the procedure listed in [After working inside your system.](#)
5. Install any device drivers required for the card as described in the documentation for the card.

## Removing the full length expansion card risers


### Prerequisites

1. Follow the safety guidelines listed in the [Safety instructions.](#)
2. Follow the procedure listed in the [Before working inside your system.](#)
3. [Remove the GPU air shroud top cover.](#)
4. If applicable, disconnect the cables from the expansion card or system board.
5.  **NOTE:** If BOSS-N1 module is installed, ensure to disconnect the BOSS-N1 power cable and Signal cable before removing the Riser 1 cage.



### Steps

1. To remove full length expansion card riser:
  - a. Loosen the captive screws on the riser.
  - b. Press the blue release tab and holding the edges, lift the expansion card riser from the riser connector on the system board.
  - c. Disconnect the GPU power cable and signal cable from the system board.

 **NOTE:** The numbers on the image do not depict the exact steps. The numbers are for representation of sequence.

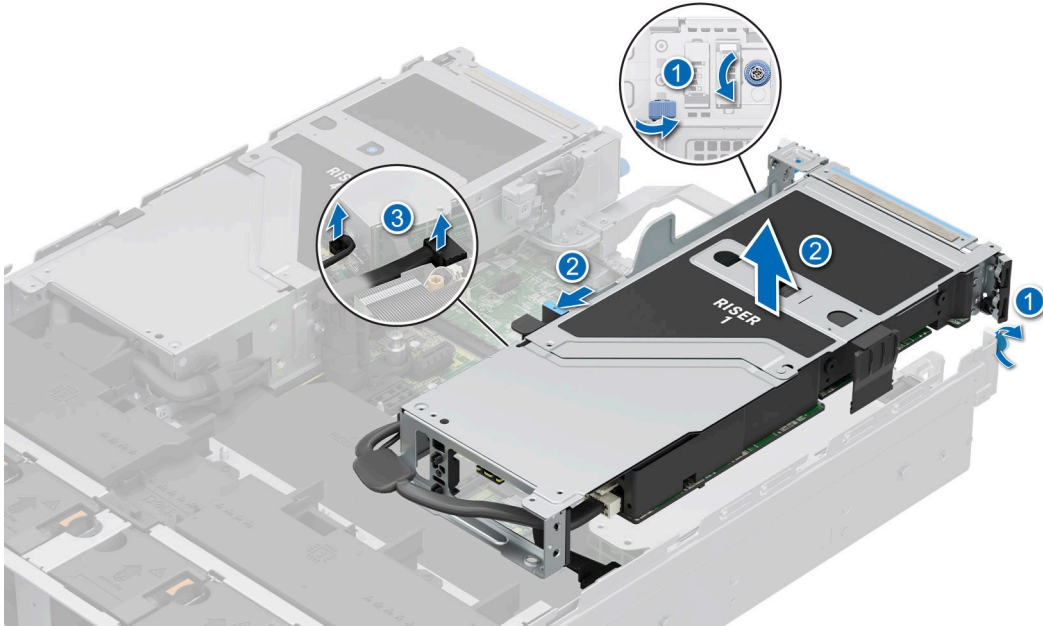


Figure 155. Removing the expansion card riser (Riser 1)

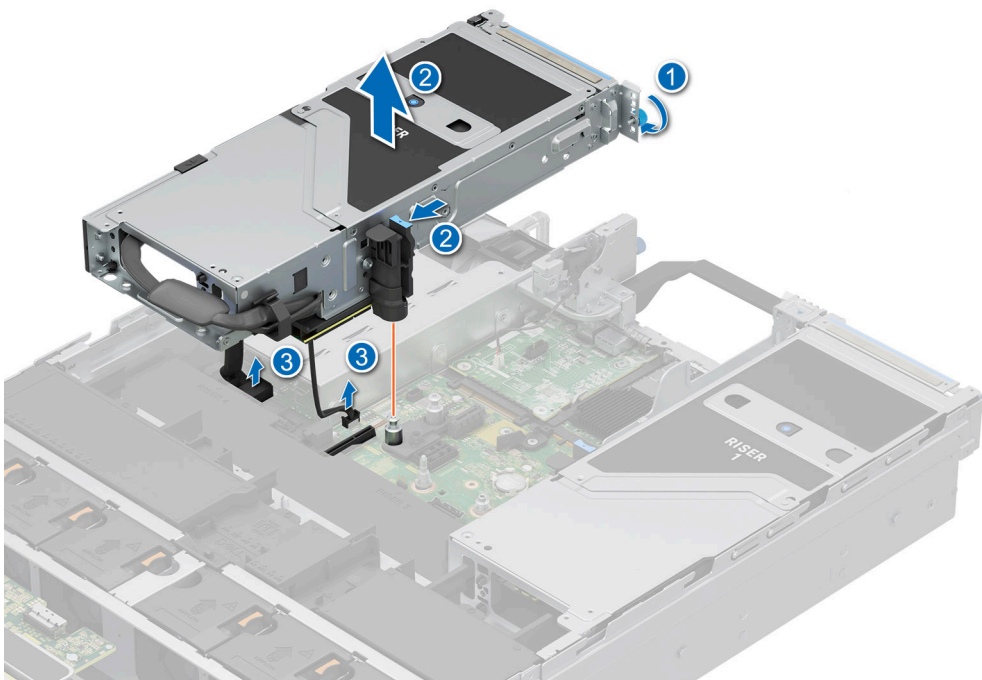
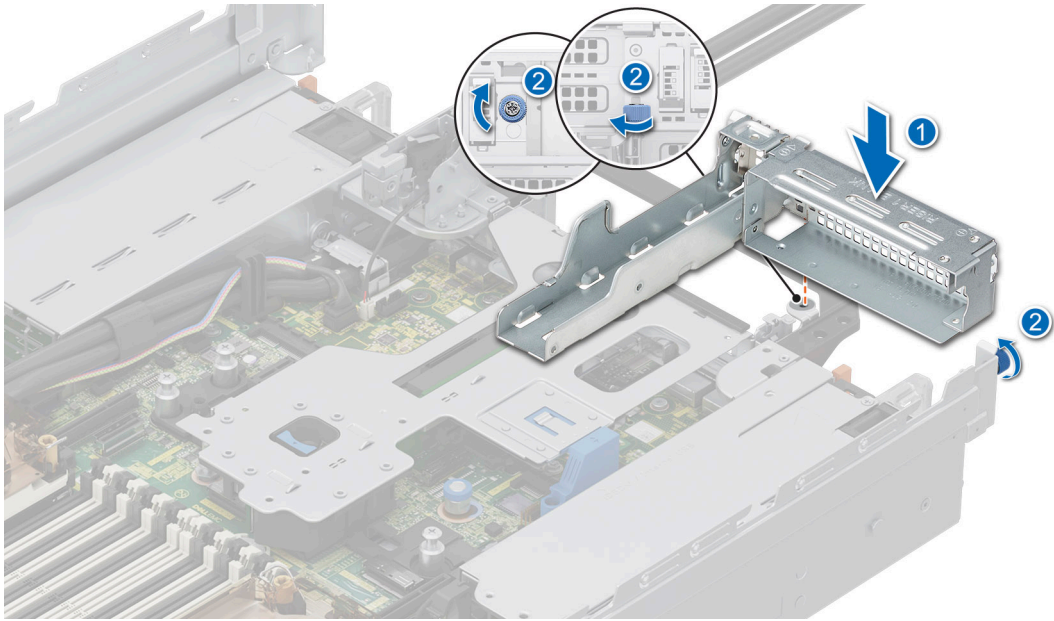


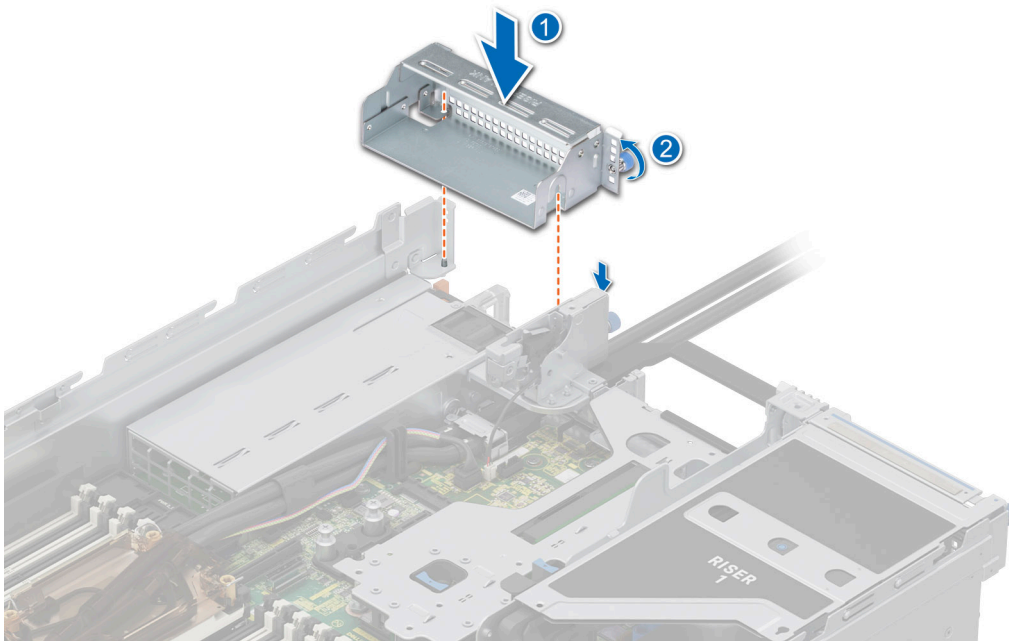
Figure 156. Removing the expansion card riser (Riser 4)

2. If the risers are not going to be replaced, install riser blanks and tighten the captive screws.

**i** **NOTE:** You must install a filler bracket over an empty expansion card slot to maintain Federal Communications Commission (FCC) certification of the system. The brackets also keep dust and dirt out of the system and aid in proper cooling and airflow inside the system.



**Figure 157. Installing the Riser 1 blank**



**Figure 158. Installing the Riser 4 blank**

### Next steps

1. Replace the full length expansion card riser.

## Installing the full length expansion card risers

### Prerequisites

1. Follow the safety guidelines listed in the [Safety instructions](#).
2. Follow the procedure listed in [Before working inside your system](#).
3. If installing full length expansion card riser for the first time, remove [air shroud](#) and replace it with [GPU air shroud](#).

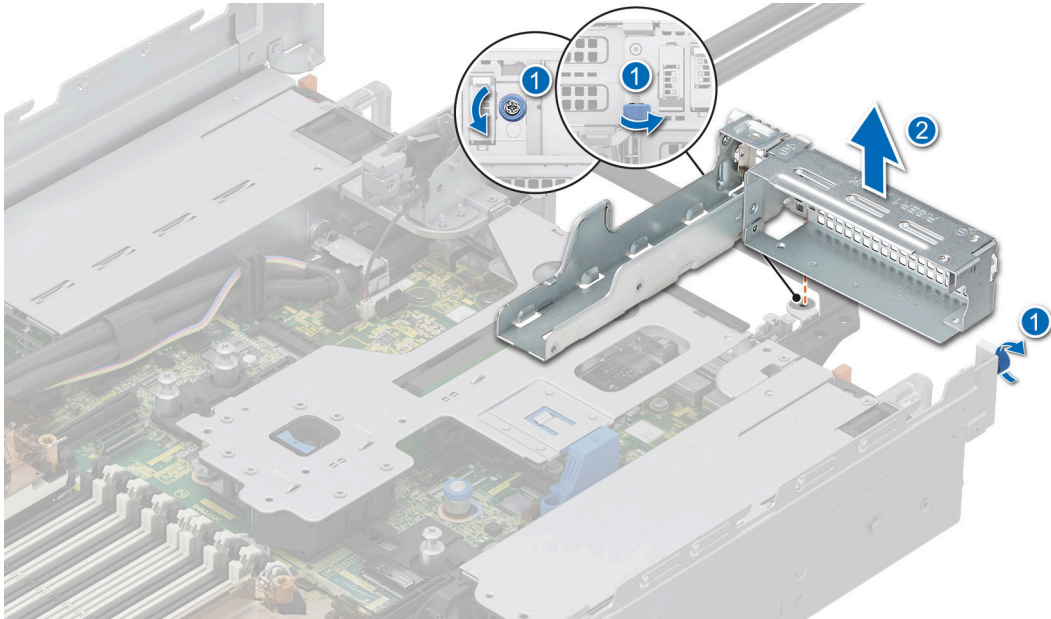
4. Remove the GPU air shroud top cover.
5. If installed, remove the GPU air shroud filler.
6. If removed, install the GPU into the expansion card risers.

**i** **NOTE:** Full length risers are supported only in Riser 1 and Riser 4 slot and first install Riser4 and then Riser1.

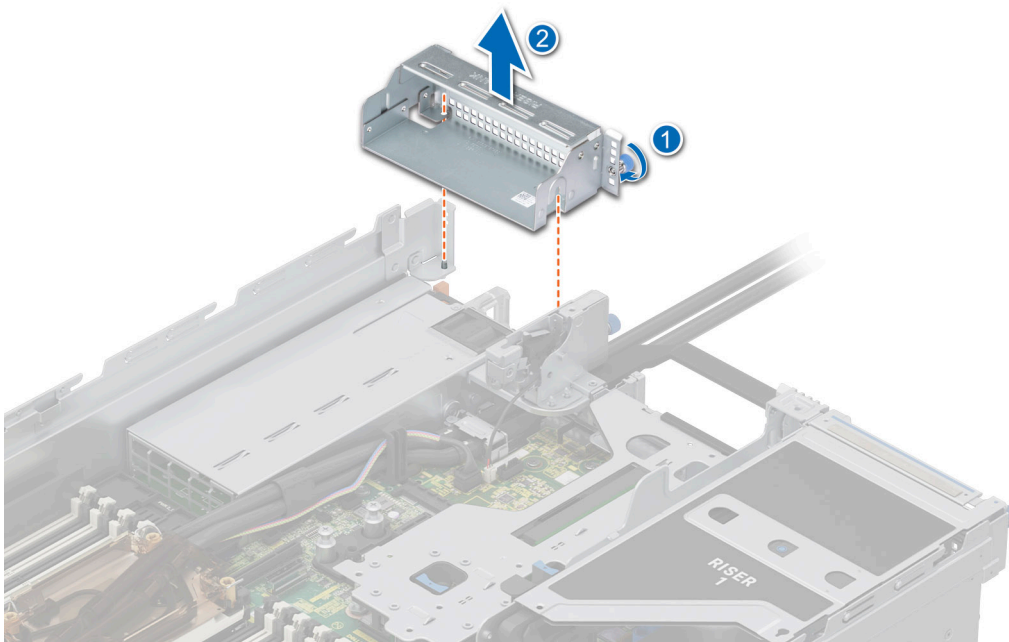
### Steps

1. If installed, remove the riser blanks by loosening the captive screws.

**i** **NOTE:** Store the Riser blanks for future use. Filler brackets must be installed in empty expansion card slots to maintain Federal Communications Commission (FCC) certification of the system. The brackets also keep dust and dirt out of the system and aid in proper cooling and airflow inside the system.

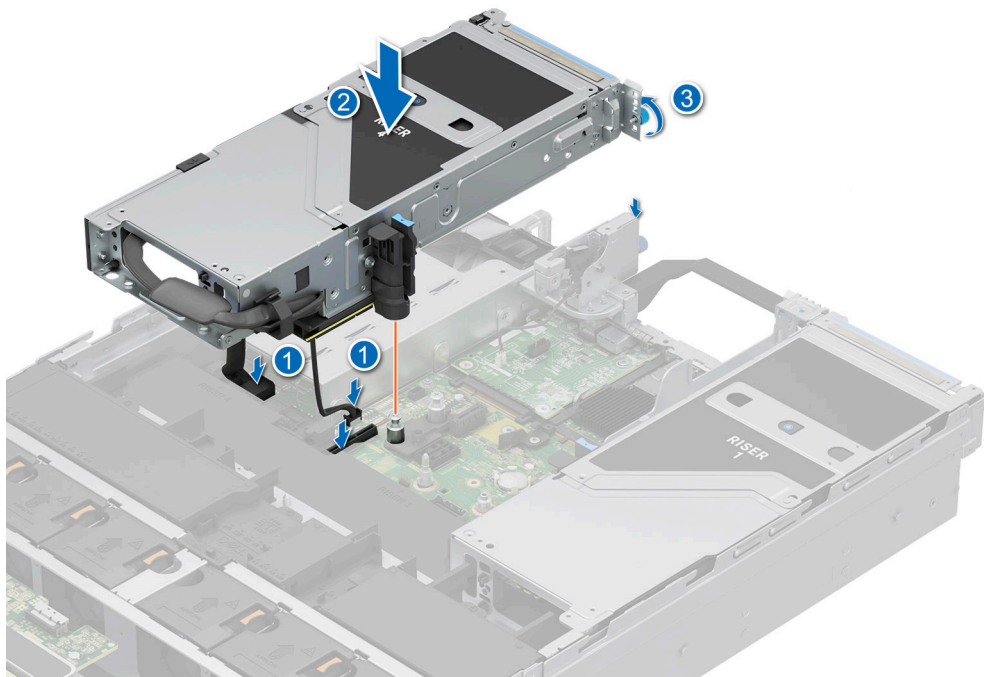


**Figure 159. Removing the Riser 1 blank**

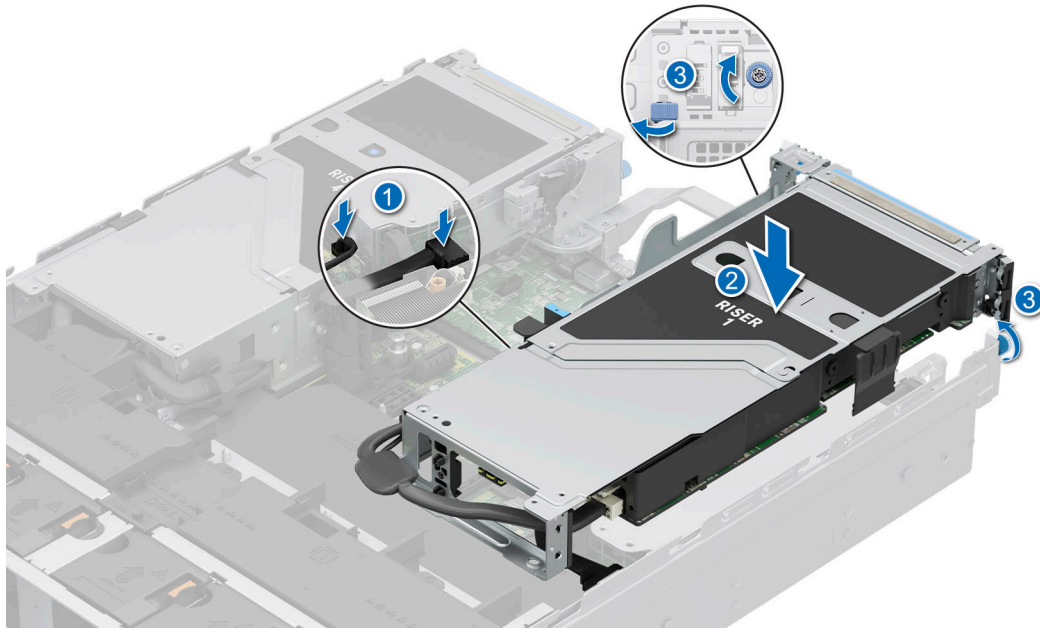


**Figure 160. Removing the Riser 4 blank**

2. To install the full length expansion card risers:
    - a. Connect the GPU power cable and signal cable to the connectors on the system board.  
**i NOTE:** Temporarily unplug and plug the VGA cable for making space to connect Riser 1 GPU power cable to system board.
    - b. Holding the edges or the touch points, align the holes on the expansion card riser with the guides on the system board and GPU air shroud.
    - c. Lower the expansion card riser into place and press the touch points until the expansion card riser connector is fully seated on the system board connector.
    - d. Tighten the captive screws on the risers and system if any.  
**i NOTE:** Route the cables properly through the riser clip.
- i NOTE:** The numbers on the image do not depict the exact steps. The numbers are for representation of sequence.



**Figure 161. Installing the expansion card riser (Riser 4)**



**Figure 162. Installing the expansion card riser (Riser 1)**

#### Next steps

1. If applicable, connect the cables to the expansion card or system board.
2. [Install the GPU air shroud top cover.](#)
3. Follow the procedure listed in [After working inside your system.](#)
4. Install any device drivers required for the card as described in the documentation for the card.

## Removing a GPU

#### Prerequisites

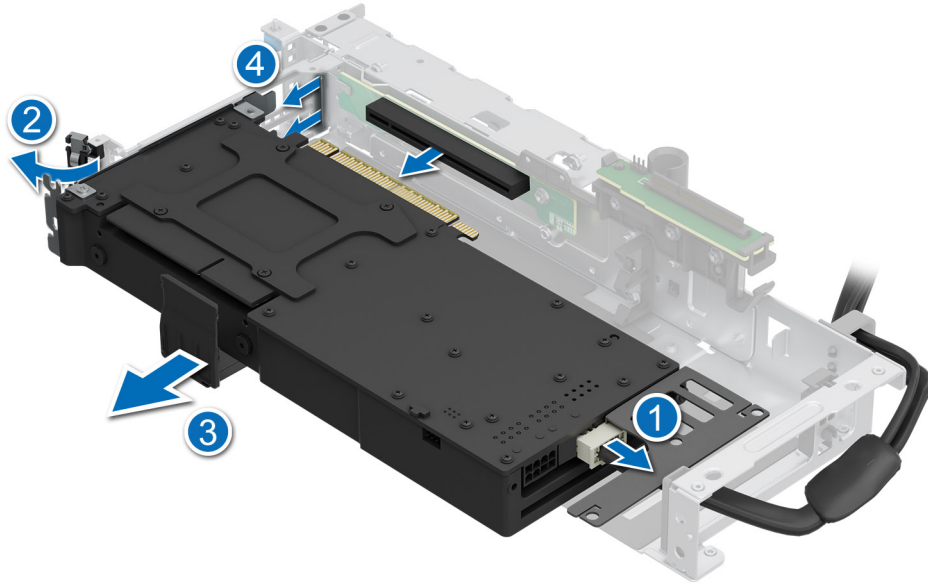
1. Follow the safety guidelines listed in the [Safety instructions.](#)
2. Follow the procedure listed in the [Before working inside your system.](#)
3. If applicable, disconnect the cables from the expansion card.
4. [Remove the GPU air shroud top cover.](#)
5. [Remove the full length expansion card riser.](#)

#### Steps

1. To remove the GPU from Riser 1:
  - a. Tilt the expansion card holder latch on the riser.
  - b. Press the tab, and pull the card holder from the riser.
  - c. Hold the GPU card by the edges and pull the card from the riser.
  - d. Disconnect the GPU power cable from the GPU card.

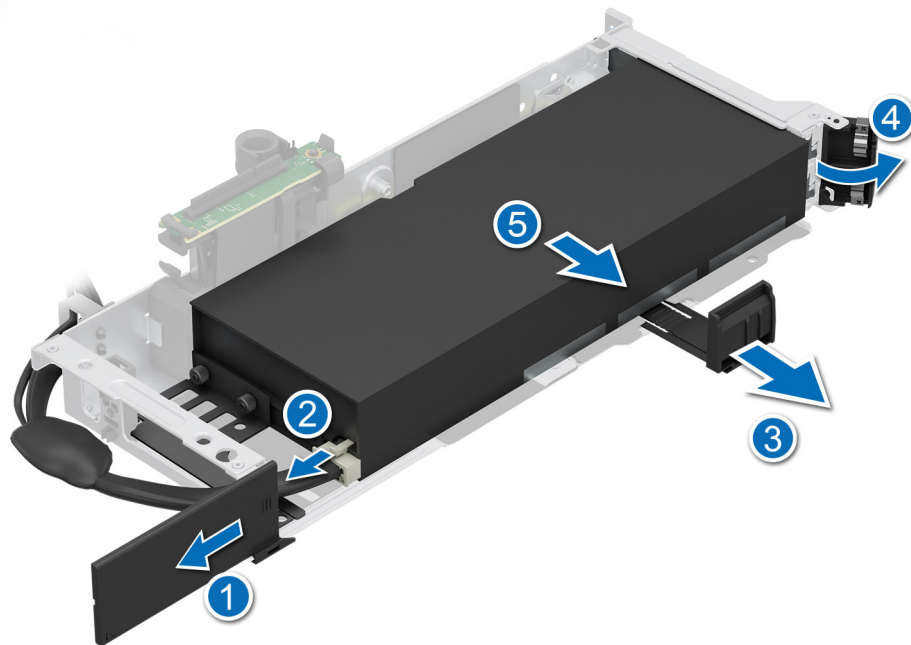
**NOTE:** The numbers on the image do not depict the exact steps. The numbers are for representation of sequence.





**Figure 163. Removing GPU from Riser 1**

2. To remove the GPU from Riser 4:
  - a. Slide the expansion card latch on the riser.
  - b. Press the tab, and pull the card holder from the riser.
  - c. Tilt the expansion card holder latch on the riser.
  - d. Hold the GPU card by the edges and pull the card from the riser.
  - e. Disconnect the GPU power cable from the GPU card.

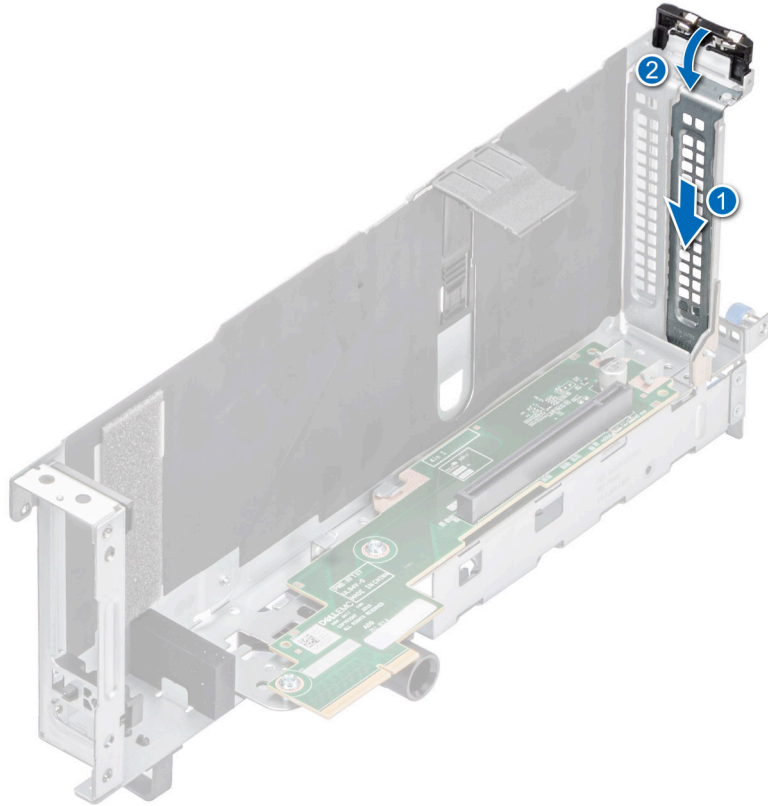


**Figure 164. Removing GPU from Riser 4**

3. If removing the GPU permanently, install a filler bracket.

**NOTE:** You must install a filler bracket over an empty expansion card slot to maintain Federal Communications Commission (FCC) certification of the system. The brackets also keep dust and dirt out of the system and aid in proper cooling and airflow inside the system. The filler bracket is necessary to maintain proper thermal conditions.

4. Install a metal filler bracket over the empty expansion slot opening and close the expansion card latch.



**Figure 165. Installing the metal filler bracket**

### Next steps

1. [Replace the GPU.](#)

## Installing a GPU

### Prerequisites

1. Follow the safety guidelines listed in the [Safety instructions](#).
2. Follow the procedure listed in [Before working inside your system](#).
3. If installing a new expansion card, unpack it and prepare the card for installation.  
**NOTE:** For instructions, see the documentation accompanying the card.
4. [Remove the GPU air shroud top cover.](#)
5. [Remove the GPU air shroud filler.](#)
6. [Remove the full length expansion card riser.](#)

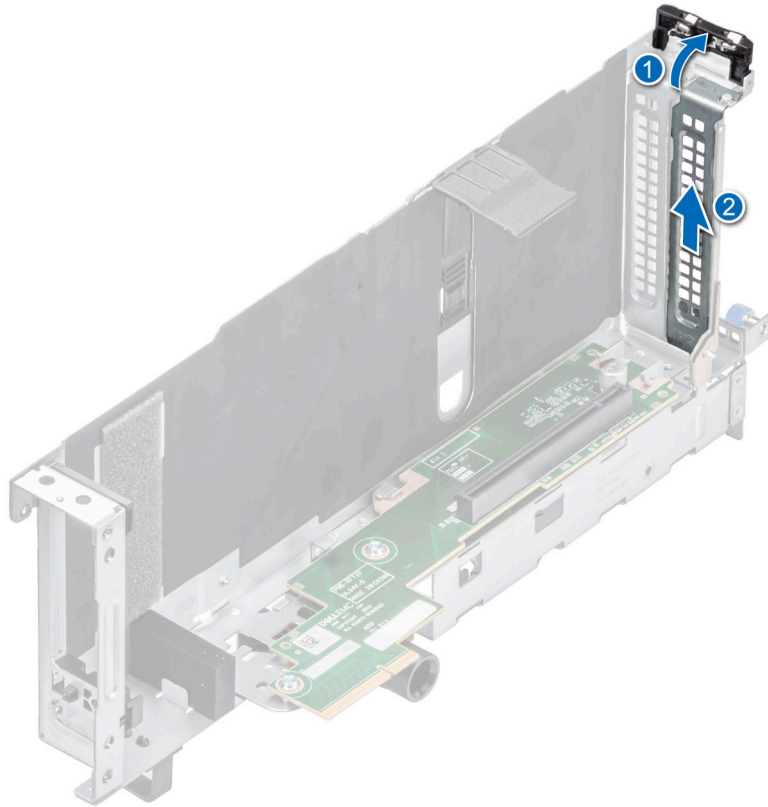
**CAUTION:** Do not install GPUs, network cards, or other PCIe devices on your system that are not validated and tested by Dell. Damage caused by unauthorized and invalidated hardware installation will null and void the system warranty.

**WARNING:** Consumer-Grade GPU should not be installed or used in the Enterprise Server products.

## Steps

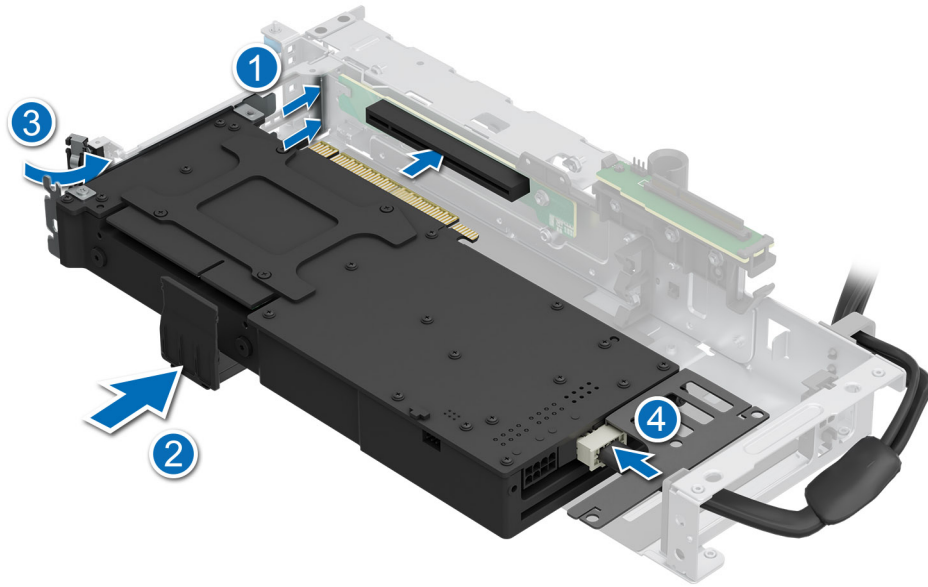
1. If installed, remove the filler bracket.

**i** **NOTE:** Store the filler bracket for future use. Filler brackets must be installed in empty expansion card slots to maintain Federal Communications Commission (FCC) certification of the system. The brackets also keep dust and dirt out of the system and aid in proper cooling and airflow inside the system.



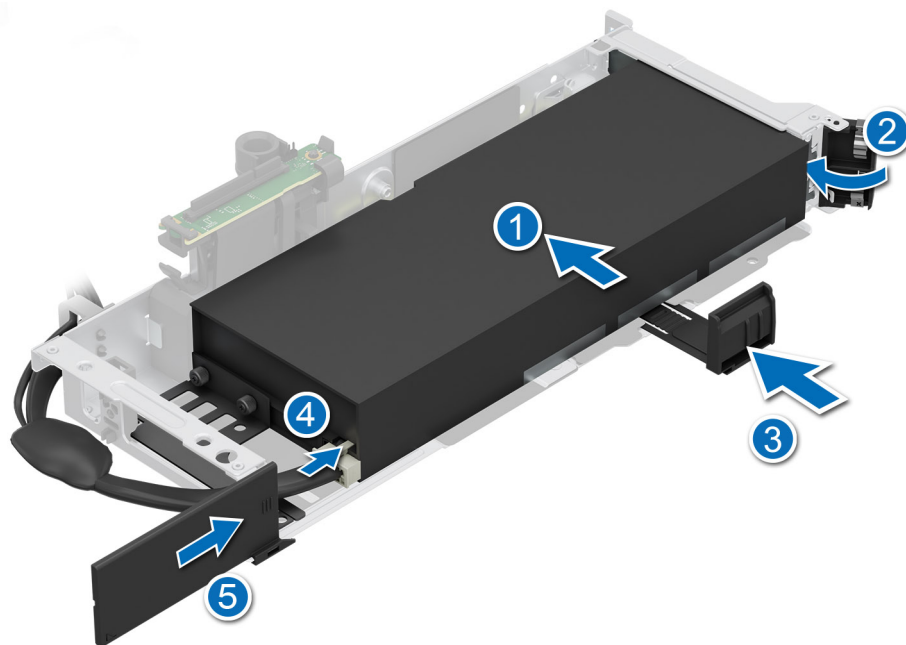
**Figure 166. Removing the filler bracket**

2. To install the GPU on Riser 1:
  - a. Connect the GPU power cable to the GPU card.
  - b. Align the connector on the GPU with the connector on the riser.
  - c. Insert the GPU into the riser until firmly seated.
  - d. Tilt the expansion card holder latch.
  - e. Press the card holder latch to secure the GPU card to the riser.



**Figure 167. Installing GPU on Riser 1**

3. To install the GPU on Riser 4:
  - a. Connect the GPU power cable to the GPU card.
  - b. Align the connector on the GPU with the connector on the riser.
  - c. Insert the GPU into the riser until firmly seated.
  - d. Tilt the expansion card holder latch.
  - e. Press the card holder latch to secure the GPU card to the riser.
  - f. Slide the expansion card latch on the riser.



**Figure 168. Installing GPU on Riser 4**

#### Next steps

1. If removed, [install the GPU air shroud](#) .

2. Install the full length expansion card riser.
3. Install the GPU air shroud top cover.
4. Follow the procedure listed in [After working inside your system](#).
5. Install any device drivers required for the card as described in the documentation for the card.

## Optional serial COM port

This is a service technician replaceable part only.

### Removing the serial COM port

The procedure to remove serial COM port from Riser 3 or 4 is same.

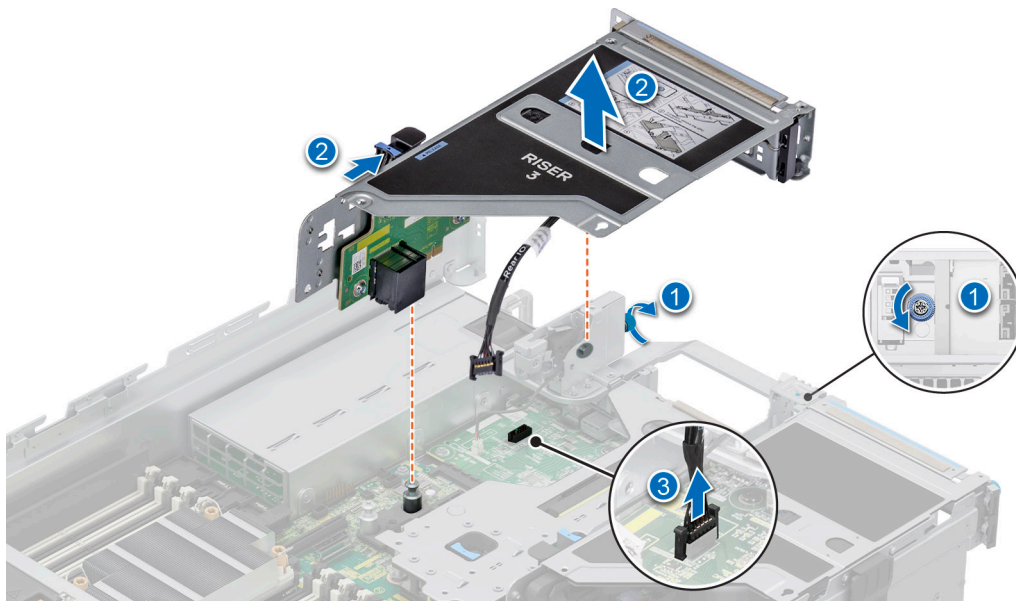
#### Prerequisites

1. Follow the safety guidelines listed in the [Safety instructions](#).
2. Follow the procedure listed in the [Before working inside your system](#).
3. [Remove the air shroud](#) or [remove the GPU air shroud](#).

**NOTE:** The serial COM port is supported only in slot 4 or slot 8 of the expansion card riser.

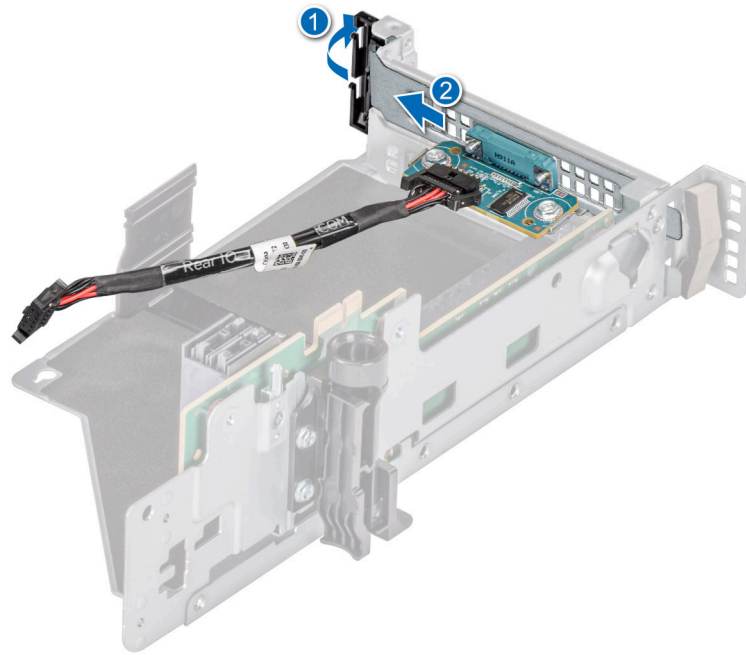
#### Steps

1. Loosen the captive screws on the system.
2. Press the blue release tab or blue button on the riser and holding the edges lift the expansion card riser from the riser connector on the system board.
3. Disconnect the serial COM port cable from the rear I/O board.



**Figure 169. Disconnecting the serial COM port**

4. Open the latch on the expansion card riser and slide the serial COM port out of the expansion card riser.



**Figure 170. Removing the Serial COM port**

5. Install the filler bracket if not replacing the serial COM port.

#### **Next steps**

1. [Replace the serial COM port.](#)

## **Installing the serial COM port**

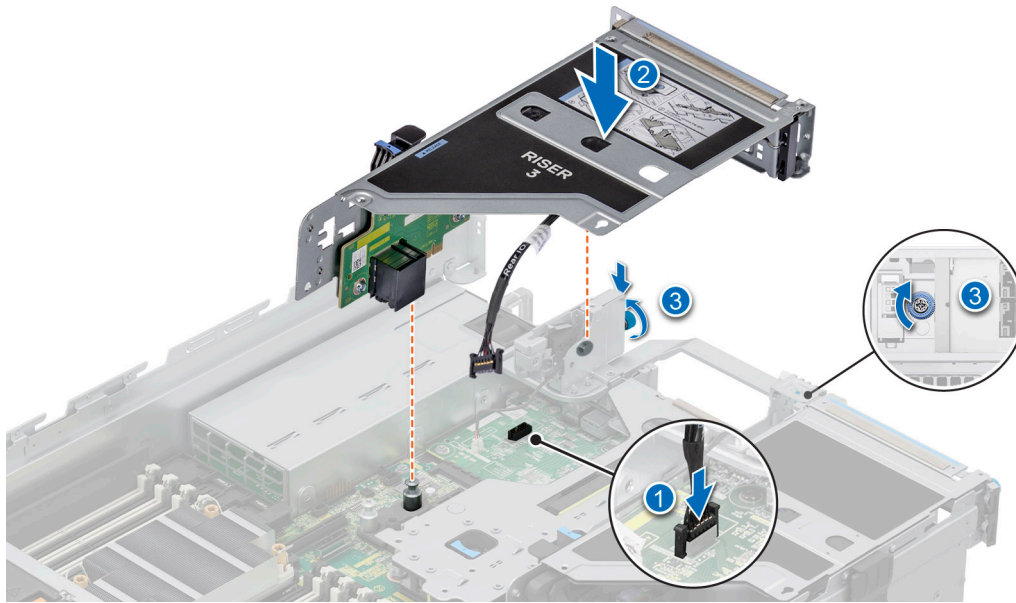
The procedure to install serial COM port to Riser 3 or 4 is same.

#### **Prerequisites**

1. Follow the safety guidelines listed in the [Safety instructions](#).
2. Follow the procedure listed in [Before working inside your system](#).
3. [Remove the air shroud](#) or [remove the GPU air shroud](#).
4. [Remove expansion card riser](#).

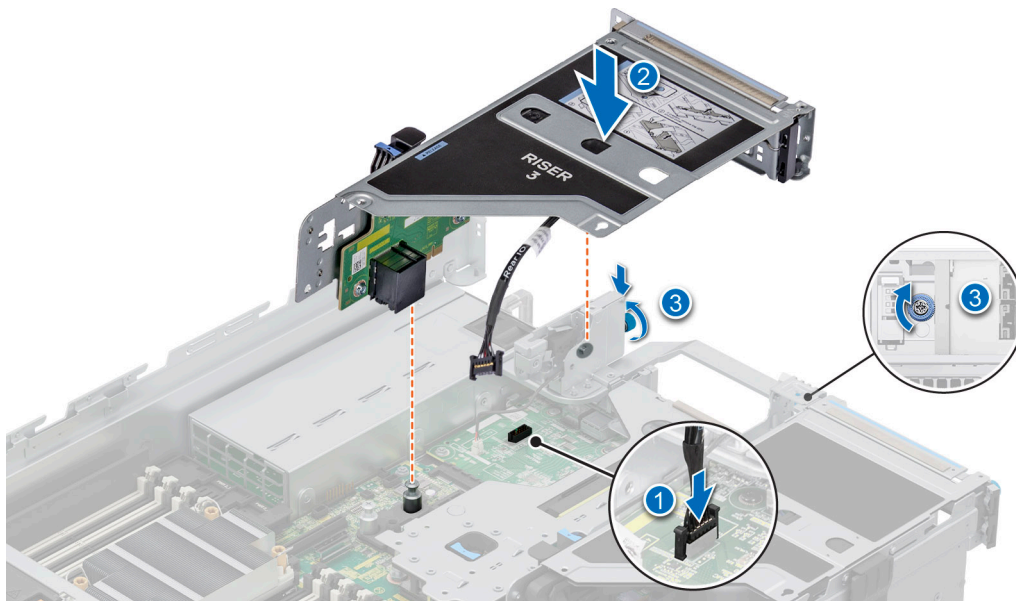
#### **Steps**

1. Open the latch on the expansion card riser and remove the filler bracket from the expansion card riser.
2. Slide the serial COM port into the expansion card riser and close the latch.



**Figure 171. Installing the serial COM port**

3. Connect the serial COM port cable to the rear I/O board.
4. Holding the edges or the touch points, align the holes on the expansion card riser with the guides on the system board.
5. Lower the expansion card riser into place and press the touch points until the expansion card riser connector is fully seated on the system board connector.
6. Tighten the captive screws on the system.



**Figure 172. Connecting the serial COM port**

**Next steps**

1. [Install the air shroud](#) or [install the GPU air shroud](#).
2. Follow the procedure listed in [After working inside your system](#).

# Optional VGA port for Direct Liquid Cooling module

## Removing the VGA port

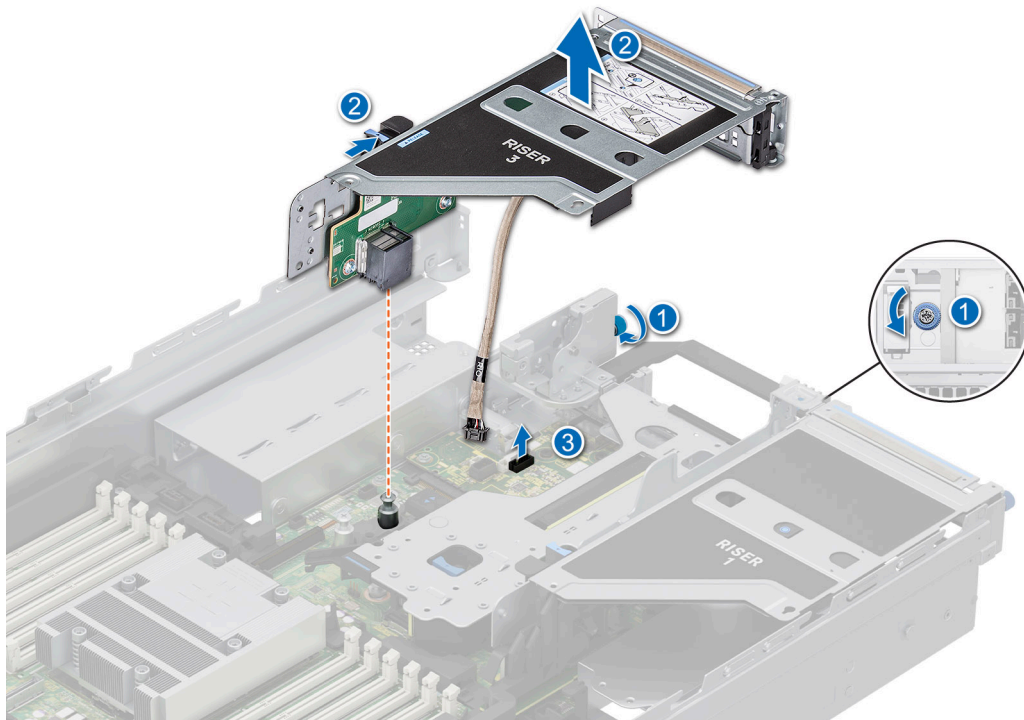
### Prerequisites

1. Follow the safety guidelines listed in the [Safety instructions](#).
2. Follow the procedure listed in the [Before working inside your system](#).
3. [Remove the air shroud](#) or [remove the GPU air shroud](#).

**NOTE:** VGA port is supported only in slot 4 of the expansion card riser.

### Steps

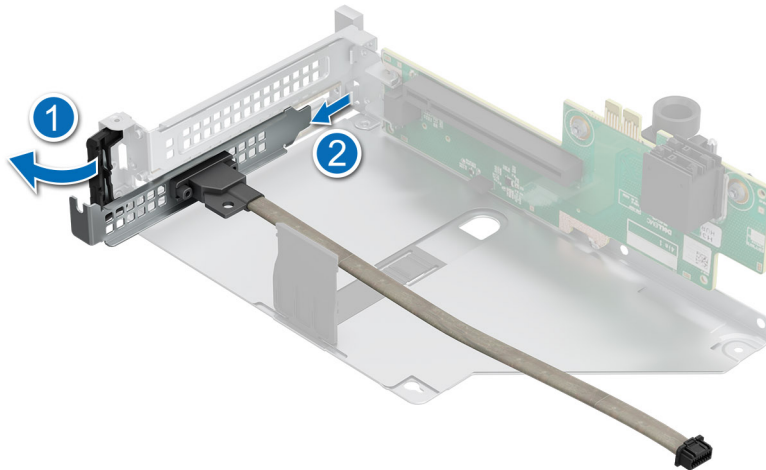
1. Loosen the captive screws on the system.
2. Press the blue release tab or blue button on the riser and holding the edges lift the expansion card riser from the riser connector on the system board.
3. Disconnect the VGA port cable from the liquid cooling (LC) rear I/O board.



**Figure 173. Disconnecting the VGA port cable**

4. Open the latch on the expansion card riser and slide the VGA port out of the expansion card riser.





**Figure 174. Removing the VGA port**

5. Install the filler bracket if not replacing the VGA port.

#### **Next steps**

1. [Replace the VGA port.](#)

## **Installing the VGA port**

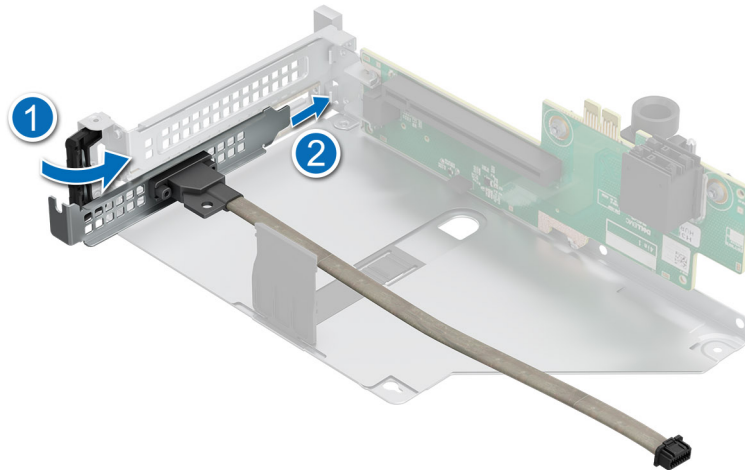
#### **Prerequisites**

1. Follow the safety guidelines listed in the [Safety instructions](#).
2. Follow the procedure listed in [Before working inside your system](#).
3. [Remove the air shroud](#) or [remove the GPU air shroud](#).
4. [Remove expansion card riser](#).

**i** **NOTE:** VGA port is supported only in slot 4 of the expansion card riser.

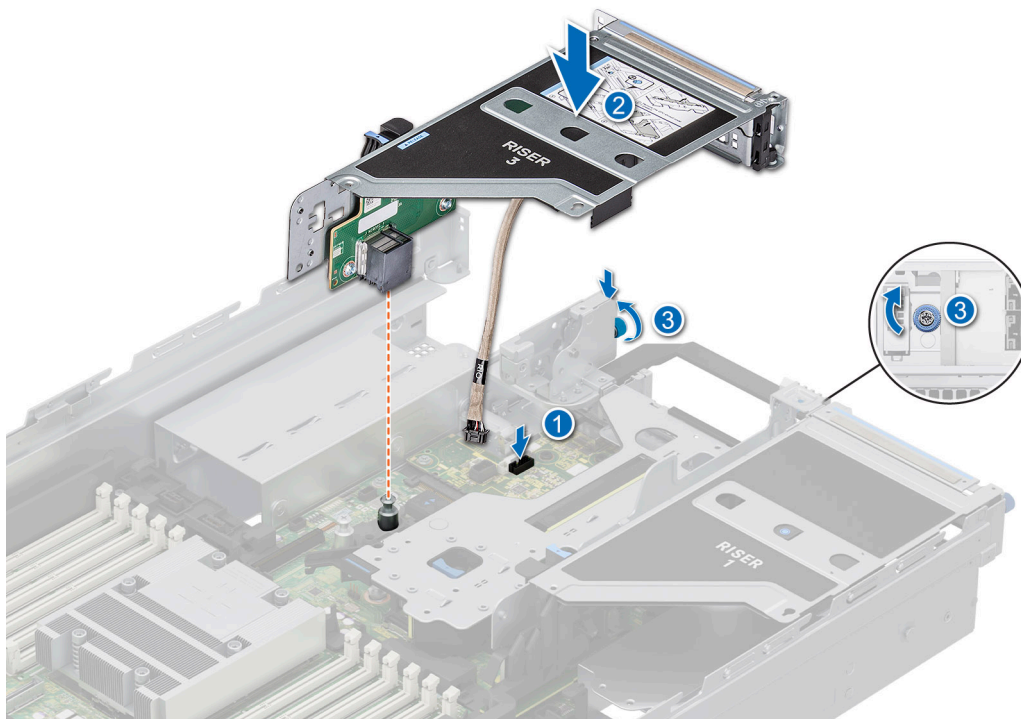
#### **Steps**

1. Open the latch on the expansion card riser and remove the filler bracket from the expansion card riser.
2. Slide the VGA port into the expansion card riser.



**Figure 175. Installing the VGA port**

3. Connect the VGA port cable to the LC rear I/O board.
4. Holding the edges or the touch points, align the holes on the expansion card riser with the guides on the system board.
5. Lower the expansion card riser into place and press the touch points until the expansion card riser connector is fully seated on the system board connector.
6. Tighten the captive screws on the system.



**Figure 176. Connecting the VGA port cable to the port on the system**

#### **Next steps**

1. [Install the air shroud](#) or [install the GPU air shroud](#).
2. Follow the procedure listed in [After working inside your system](#).

# Optional BOSS-N1 module

## Removing the BOSS-N1 module blank

### Prerequisites

Follow the safety guidelines listed in the [Safety instructions](#).

### Steps

Use a screwdriver to push out the blank from the BOSS-N1 module bay.

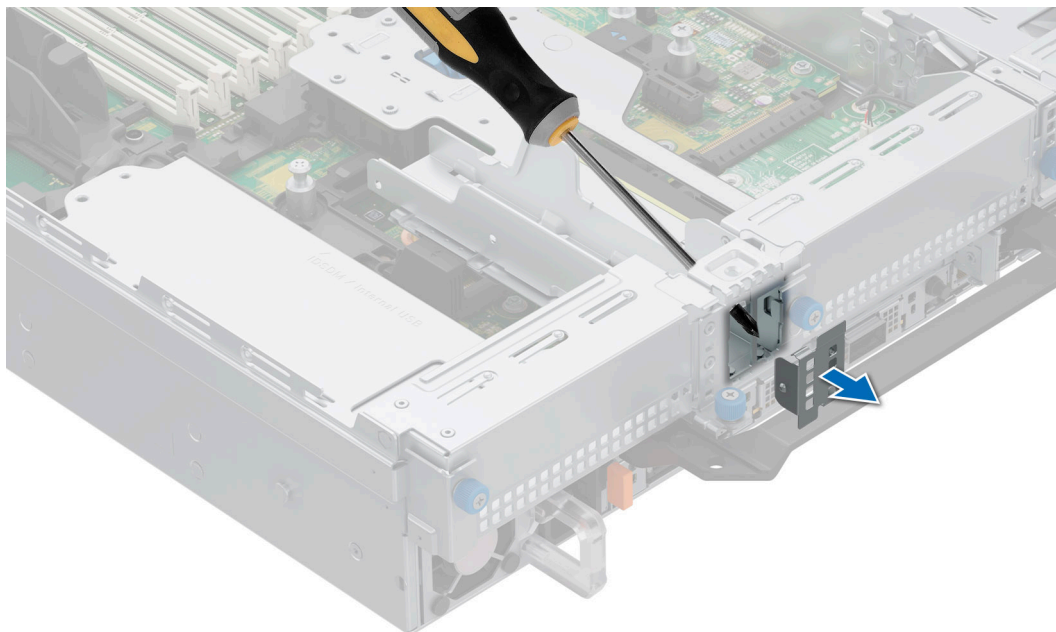


Figure 177. Removing the BOSS-N1 module blank

### Next steps

1. [Replace the BOSS-N1 module blank](#) or install BOSS-N1 module.

## Installing the BOSS-N1 module blank

### Prerequisites

1. Follow the safety guidelines listed in the [Safety instructions](#).

### Steps

Align the blank with the BOSS-N1 module bay and push it into the bay until it clicks into place.

SS

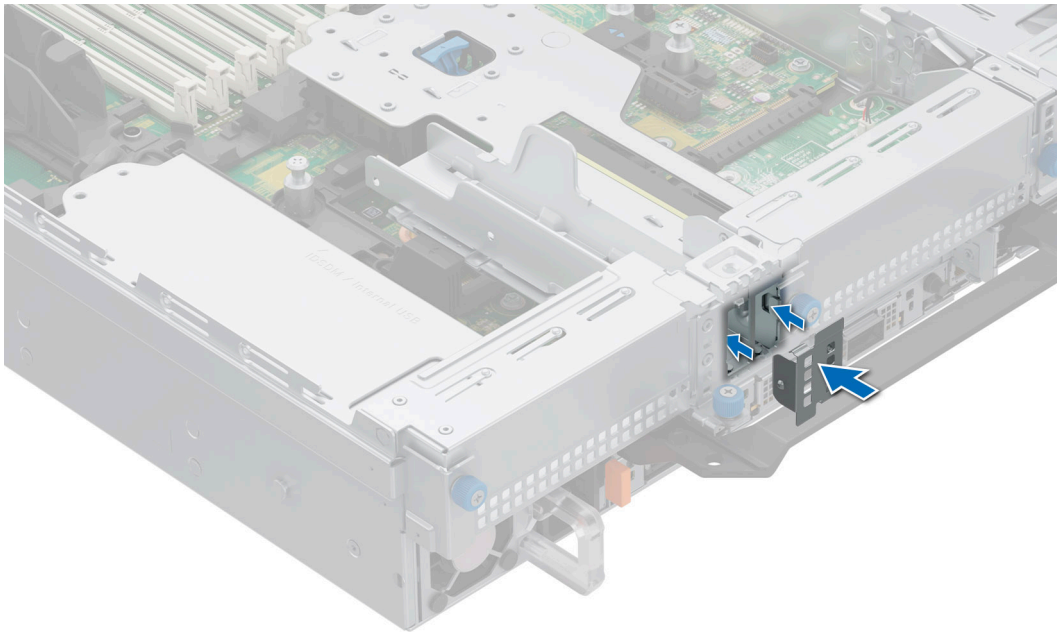


Figure 178. Installing the BOSS-N1 module blank

## Removing the BOSS-N1 card carrier blank

### Prerequisites

Follow the safety guidelines listed in the [Safety instructions](#).

### Steps

Press and pull the BOSS-N1 card carrier blank out from the BOSS-N1 module.

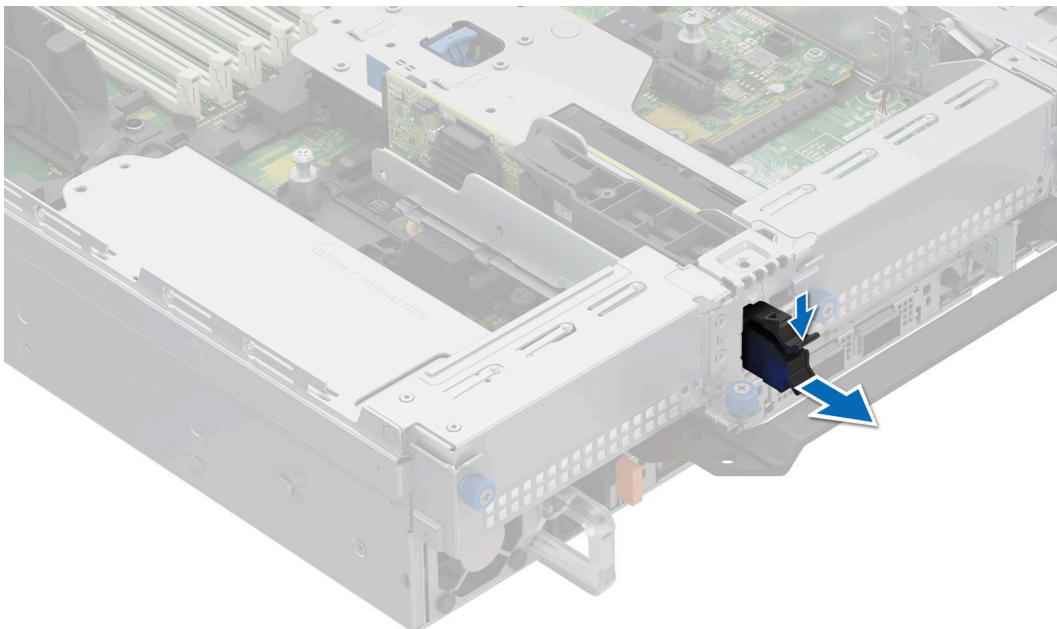


Figure 179. Removing the BOSS-N1 card carrier blank

### Next steps

1. [Replace the BOSS-N1 card carrier blank.](#)

## Installing the BOSS-N1 card carrier blank

### Prerequisites

1. Follow the safety guidelines listed in the [Safety instructions](#).

### Steps

Align the blank with the BOSS-N1 module bay and push it into the bay until it clicks into place.

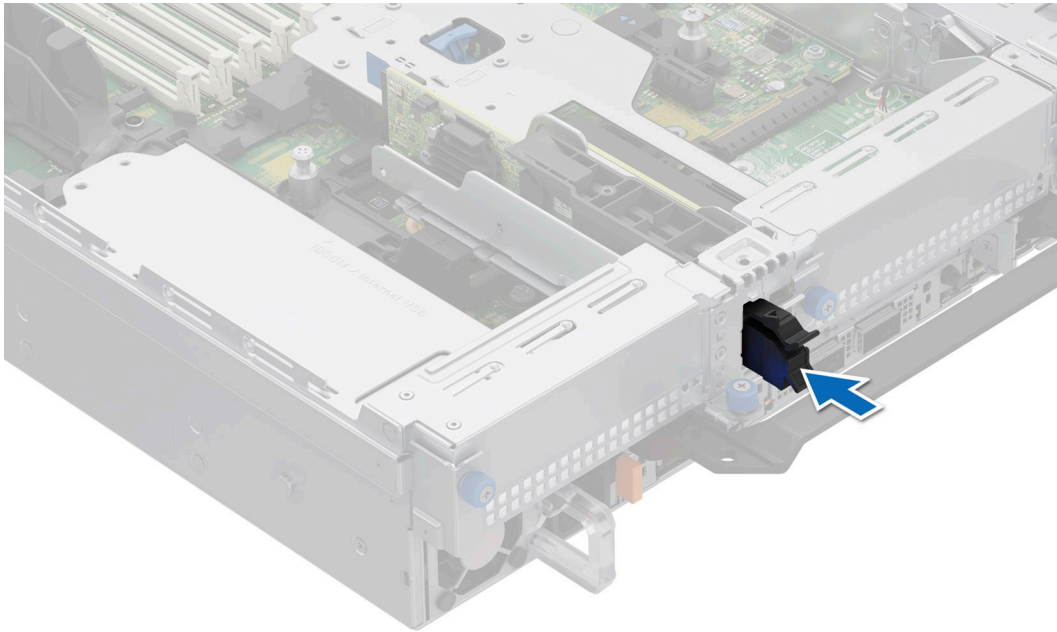


Figure 180. Installing the BOSS-N1 card carrier blank

## Removing the BOSS-N1 module

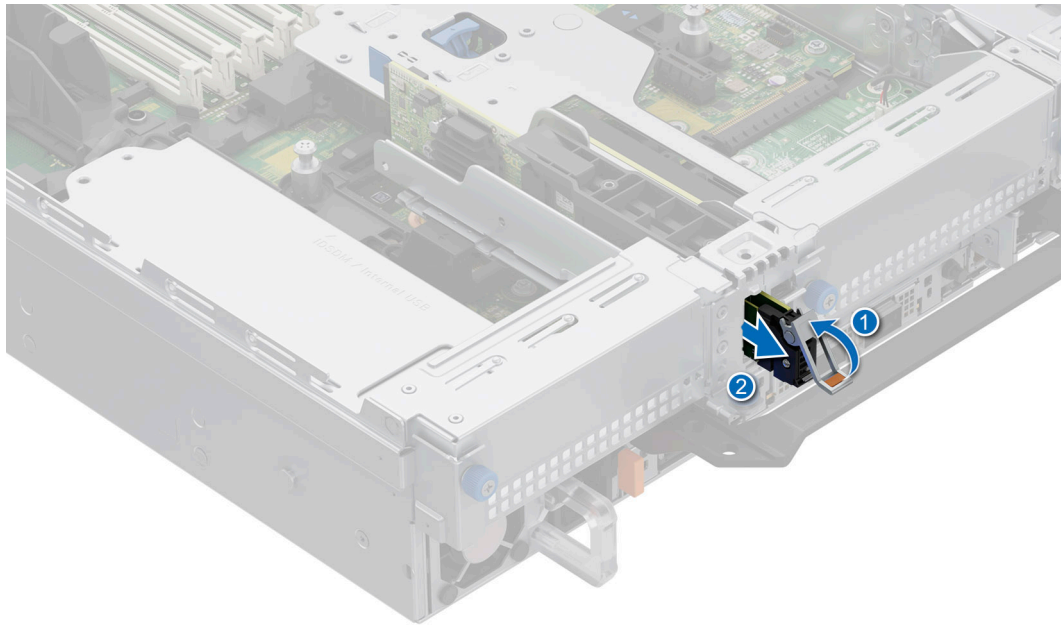
The procedure to remove is the BOSS-N1 module with 4 x 2.5-inch rear drive module is similar.

### Prerequisites

1. Follow the safety guidelines listed in the [Safety instructions](#).
2. Follow the procedure listed in the [Before working inside your system](#).

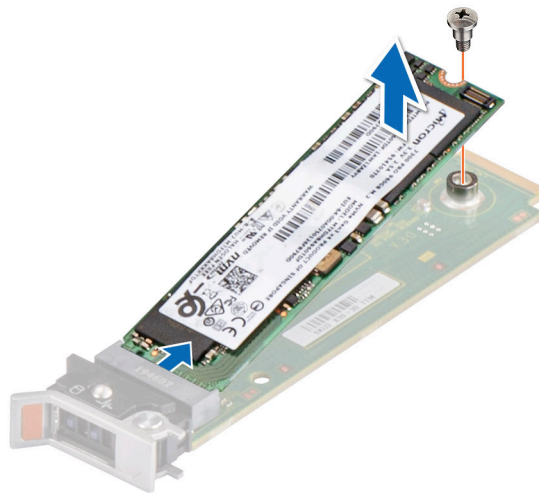
### Steps

1. **(i) NOTE:** The numbers on the image do not depict the exact steps. The numbers are for representation of sequence.  
Pull and lift the BOSS-N1 card carrier retention latch lock to open.
2. Slide the BOSS-N1 card carrier out.



**Figure 181. Removing the BOSS-N1 card carrier**

3. Using the Phillips #1 screwdriver remove the M3 x 0.5 x 4.5 mm screw that secures the M.2 SSD to the BOSS-N1 card carrier.
4. Slide the M.2 SSD out from the BOSS-N1 card carrier.



**Figure 182. Removing the M.2 SSD**

5. Disconnect the BOSS-N1 power and signal cable from the system board.
6. Using the Phillips #1 screwdriver remove the M3 x 0.5 x 4.5 mm screw that secures the BOSS-N1 module on Riser 1.
7. Slide the BOSS-N1 module towards the front of the chassis and lift the module.

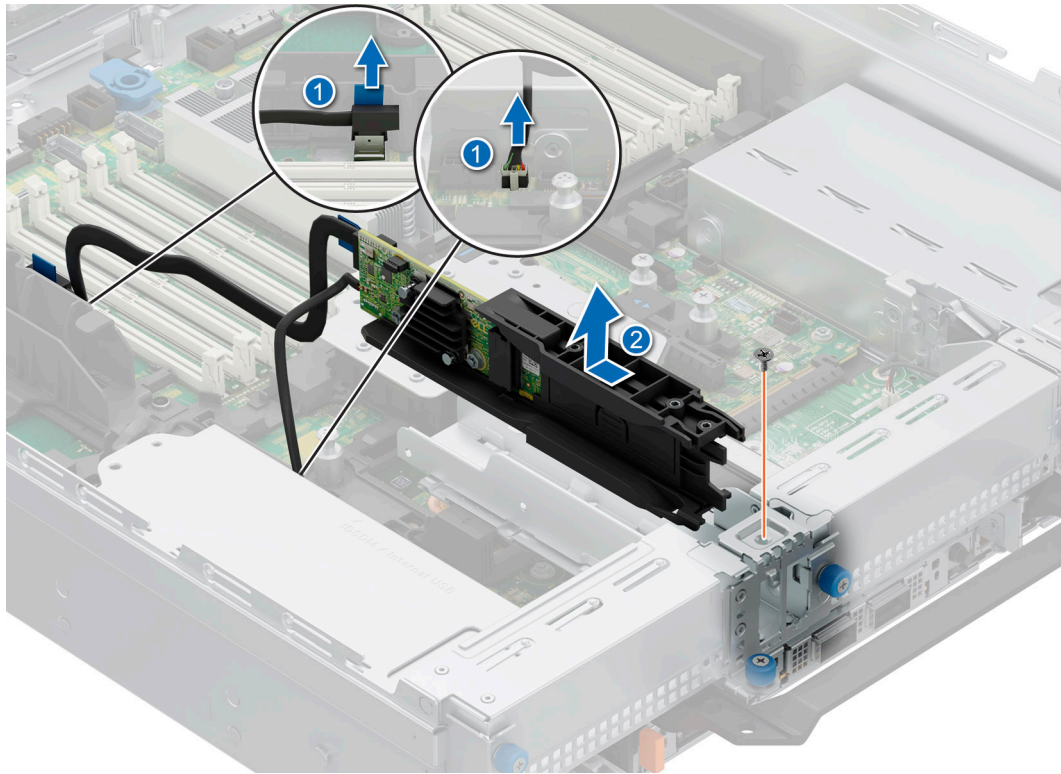


Figure 183. Removing the BOSS-N1 module

#### Next steps

1. [Replace the BOSS-N1 module](#) or [Install the BOSS-N1 module blank](#).

## Installing the BOSS-N1 module

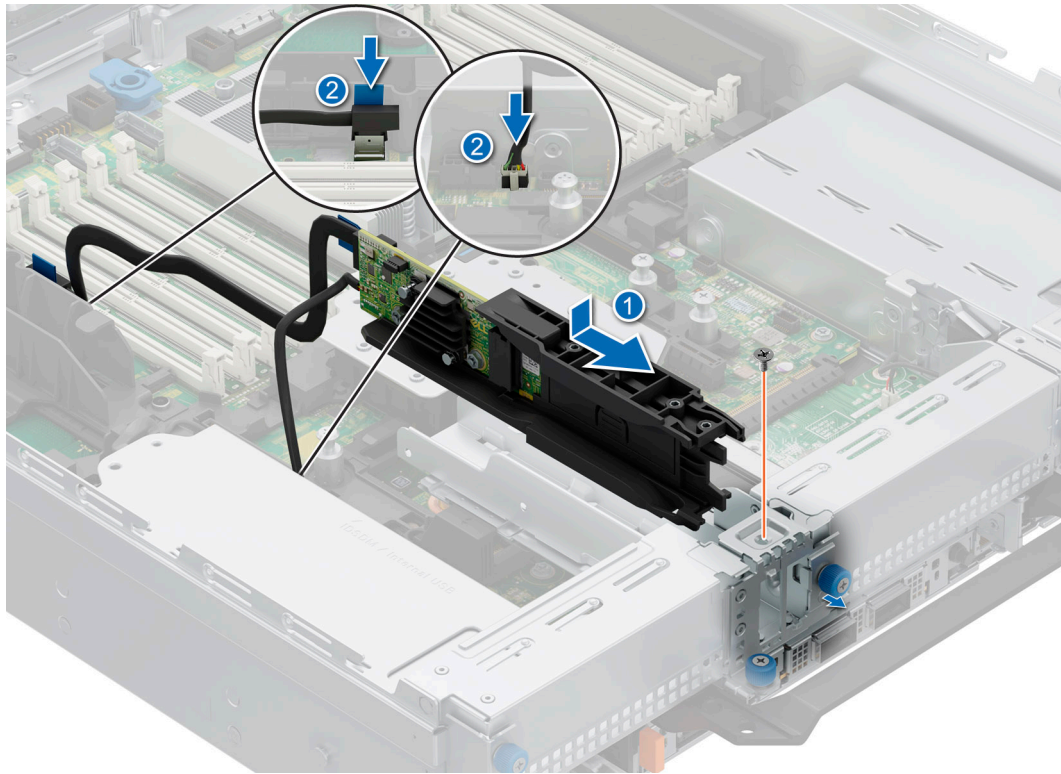
The procedure to install is the BOSS-N1 module with 4 x 2.5-inch rear drive module is similar.

#### Prerequisites

1. Follow the safety guidelines listed in the [Safety instructions](#).
2. Follow the procedure listed in the [Before working inside your system](#).
3. If installed, [remove the BOSS module blank](#).

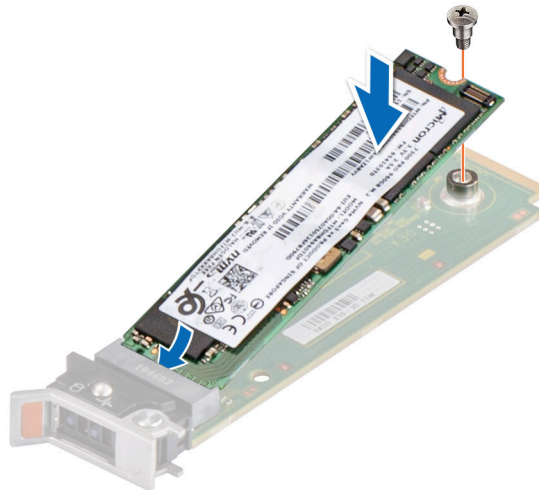
#### Steps

1. **NOTE:** The numbers on the image do not depict the exact steps. The numbers are for representation of sequence.  
Align the BOSS-N1 module at an angle with the controller card module slot.
2. Insert the BOSS-N1 module and push the module horizontally towards the rear of the system until it is firmly seated.
3. Using the Phillips #1 screwdriver, secure the BOSS-N1 module with the M3 x 0.5 x 4.5 mm screw.
4. Connect the BOSS-N1 power and signal cable to the connectors on the system board.



**Figure 184. Installing the BOSS-N1 module**

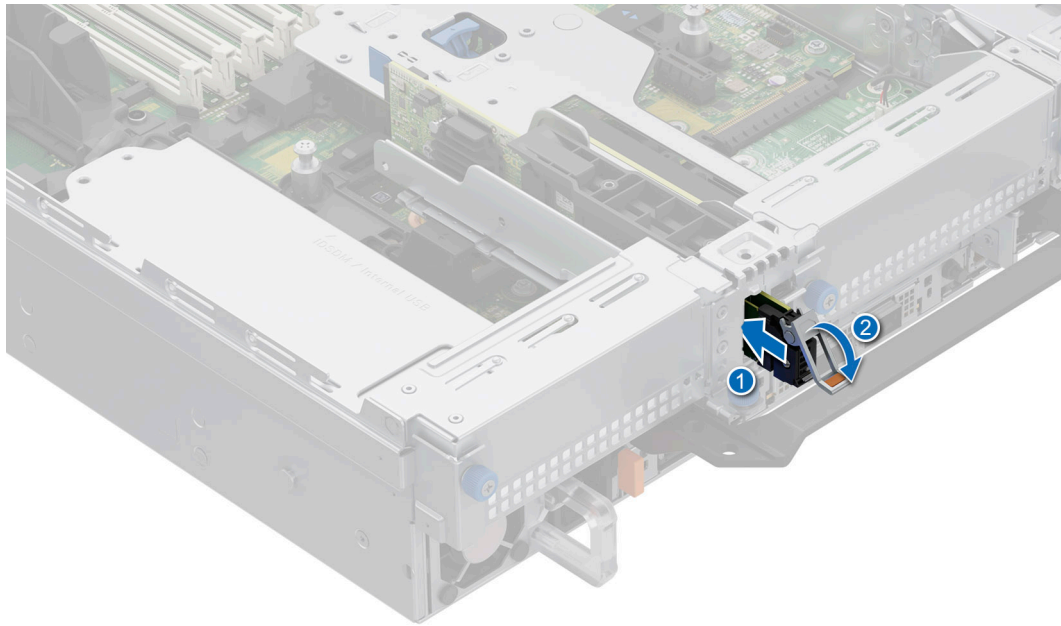
5. Align the M.2 SSD at an angle with the BOSS-N1 card carrier.
6. Insert the M.2 SSD until it is firmly seated in the BOSS-N1 card carrier.
7. Using the Phillips #1 screwdriver, secure the M.2 SSD on the BOSS-N1 card carrier with the M3 x 0.5 x 4.5 mm screw.



**Figure 185. Installing the M.2 SSD**

8. Slide the BOSS-N1 card carrier into the BOSS-N1 module slot.
9. Close the BOSS-N1 card carrier release latch to lock the carrier in place.





**Figure 186. Installing the BOSS-N1card carrier**

#### Next steps

1. Follow the procedure listed in the [After working inside your system](#).

## System battery

### Replacing the system battery

#### Prerequisites

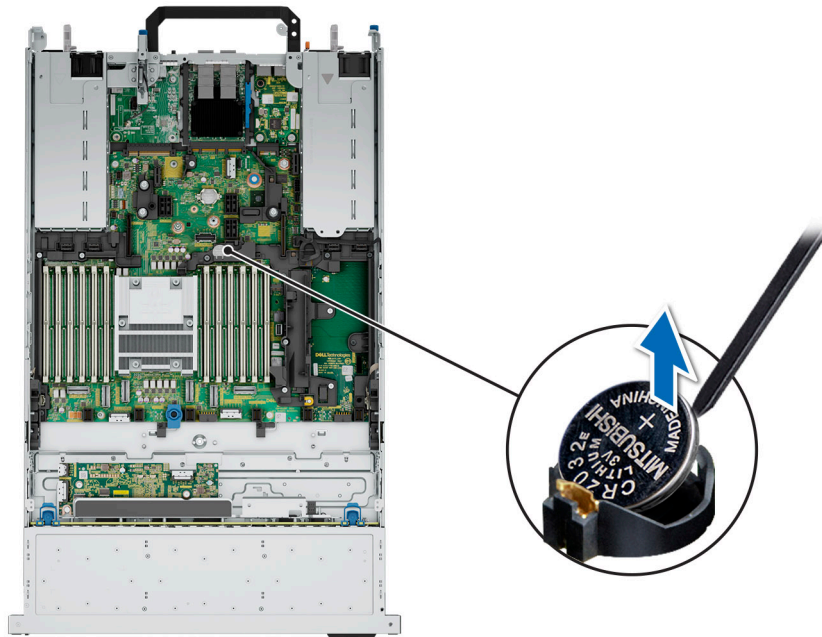
**NOTE:** There is a danger of a new battery exploding if it is incorrectly installed. Replace the battery only with the same or equivalent type that is recommended by the manufacturer. Discard used batteries according to the manufacturer's instructions. See the [Safety instructions](#) that came with your system for more information.

1. Follow the safety guidelines listed in the [Safety instructions](#).
2. Follow the procedure listed in the [Before working inside your system](#).
3. [Remove the air shroud](#).
4. Locate the battery socket. For more information, see the System board jumpers and connectors section.

#### Steps

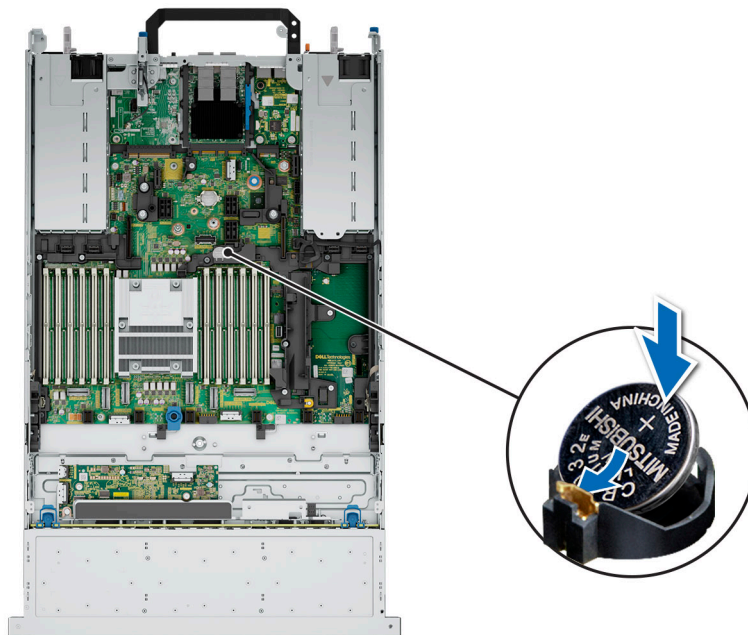
1. Use a plastic scribe and Press the release latch until the battery pops out.

**NOTE:** Ensure that the + side of the battery is facing upwards.



**Figure 187. Removing the system battery**

2. To install a system battery, press the battery into the connector until it snaps into place.
3. Insert the battery in the battery holder until the battery holder clip snaps into place.



**Figure 188. Installing the system battery**

### Next steps

1. [Install the air shroud.](#)
2. Follow the procedure listed in [After working inside your system.](#)
3. Confirm that the battery is operating properly, by performing the following steps:
  - a. Enter the System Setup, while booting, by pressing **F2**.
  - b. Enter the correct time and date in the System Setup **Time** and **Date** fields.
  - c. **Exit** the System Setup.

- d. To test the newly installed battery, remove the system from the enclosure for at least an hour.
- e. Reinstall the system into the enclosure after an hour.
- f. Enter the System Setup and if the time and date are still incorrect, see [Getting help](#) section.

## Optional internal USB card

**NOTE:** To locate the internal USB port on the system board, see the [System board jumpers and connectors](#) section.

## Removing the internal USB card

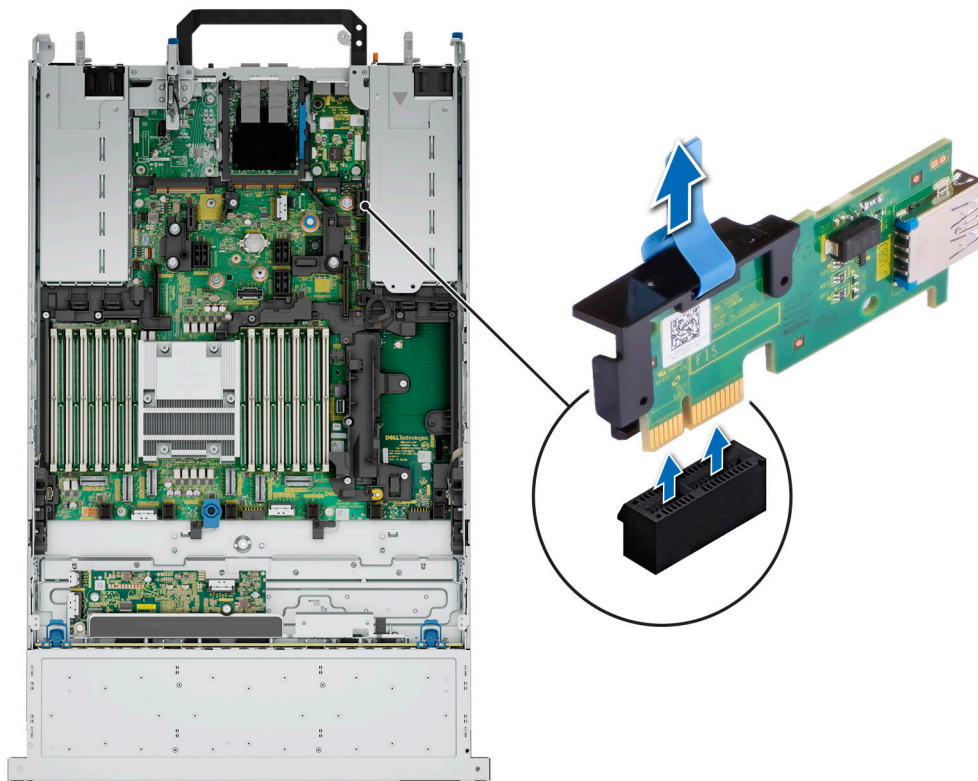
### Prerequisites

**CAUTION:** To avoid interference with other components in the server, the maximum permissible dimensions of the USB memory key are 15.9 mm wide x 57.15 mm long x 7.9 mm high.

1. Follow the safety guidelines listed in the [Safety instructions](#).
2. Follow the procedure listed in the [Before working inside your system](#).
3. [Remove the expansion card risers](#).

### Steps

1. Holding the blue tag, lift the internal USB card to disconnect from the connector on the system board.
2. Remove the USB memory key from the internal USB card.



**Figure 189. Removing the internal USB card**

### Next steps

1. [Replace the internal USB card](#).

# Installing the internal USB card

## Prerequisites

1. Follow the safety guidelines listed in the [Safety instructions](#).
2. Follow the procedure listed in the [Before working inside your system](#).
3. [Remove the expansion card risers](#).

## Steps

1. Connect the USB key to the internal USB card.

**NOTE:** For information about the exact location of USB on system board, see [System board jumpers and connectors](#) section.

2. Align the internal USB card with the connector on the system board and press firmly until the internal USB card is seated.

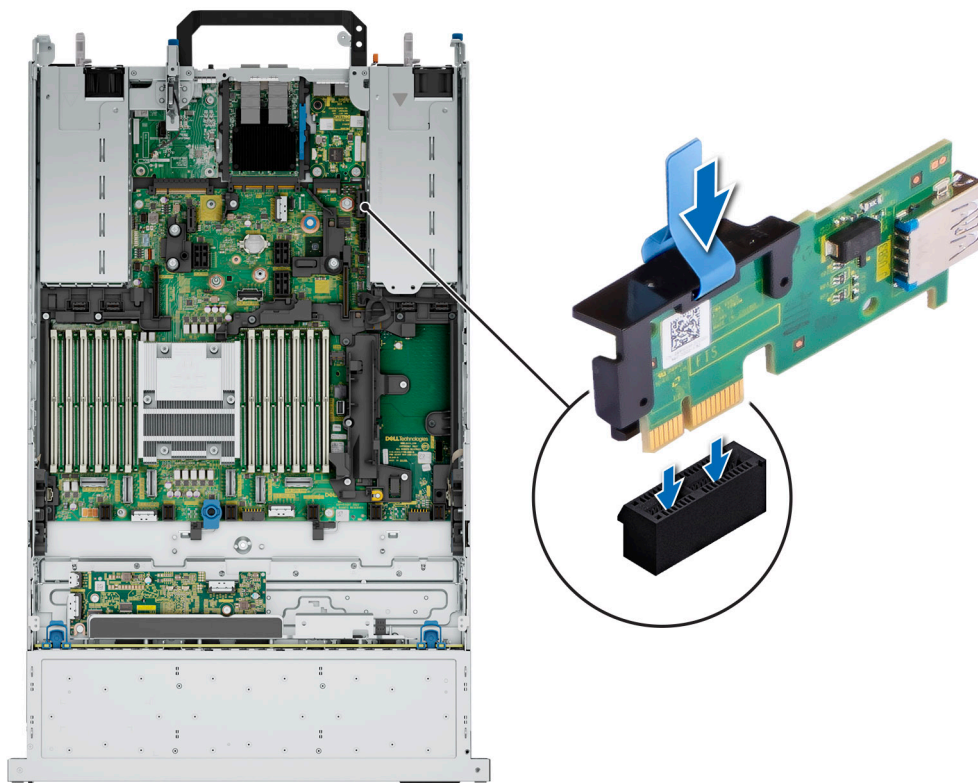


Figure 190. Installing the internal USB card

## Next steps

1. [Install the expansion card risers](#).
2. Follow the procedure listed in [After working inside your system](#).
3. While booting, press F2 to enter **System Setup** and verify that the system detects the USB memory key.

# Intrusion switch module

## Removing the intrusion switch

### Prerequisites

1. Follow the safety guidelines listed in the [Safety instructions](#).
2. Follow the procedure listed in the [Before working inside your system](#).
3. [Remove the air shroud](#).
4. Keep the plastic scribe ready.

### Steps

1. Disconnect and remove the intrusion switch cable connector from connector on the system board.

**NOTE:** Observe the routing of the cable as you remove it from the system.

2. Using a Phillips #2 screwdriver, remove the screw that secures the intrusion switch on the intrusion switch slot.
3. Lift to remove the intrusion switch out of the intrusion switch slot.

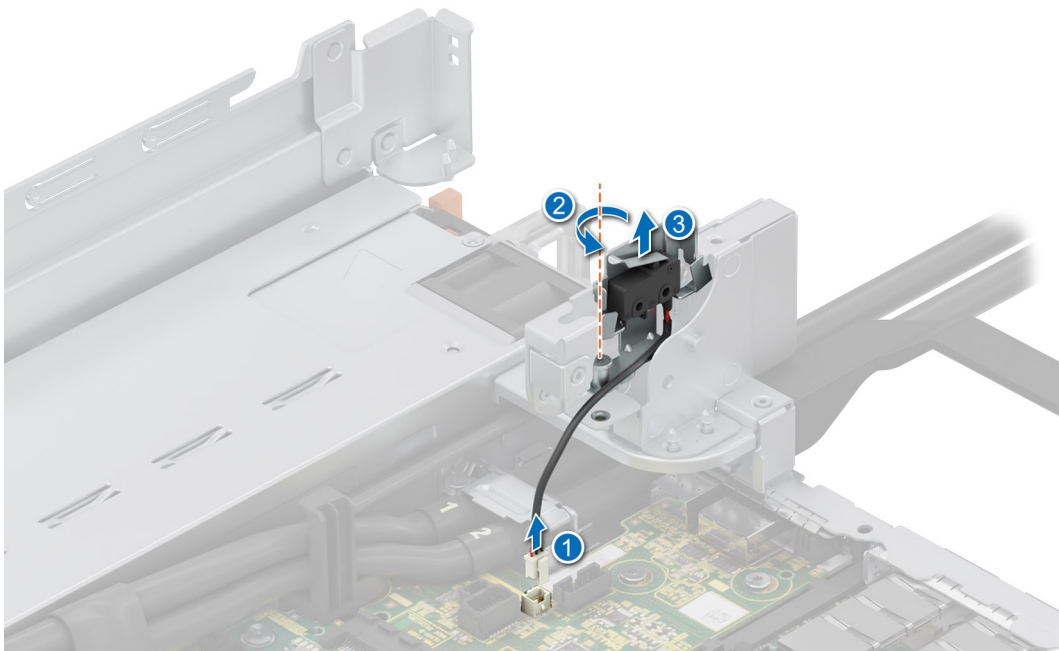


Figure 191. Removing the intrusion switch

### Next steps

1. [Replace the intrusion switch](#).

## Installing the intrusion switch

### Prerequisites

1. Follow the safety guidelines listed in the [Safety instructions](#).
2. Follow the procedure listed in the [Before working inside your system](#).
3. [Remove the air shroud](#).

### Steps

1. Align and insert the intrusion switch in the slot until it is firmly seated in the slot on the system.
- NOTE:** Route the cable properly when you replace it to prevent the cable from being pinched or crimped.
2. Using a Phillips #2 screwdriver, tighten the screw that secures the intrusion switch on the intrusion switch slot.
  3. Connect the intrusion switch cable to the connector on the system board.

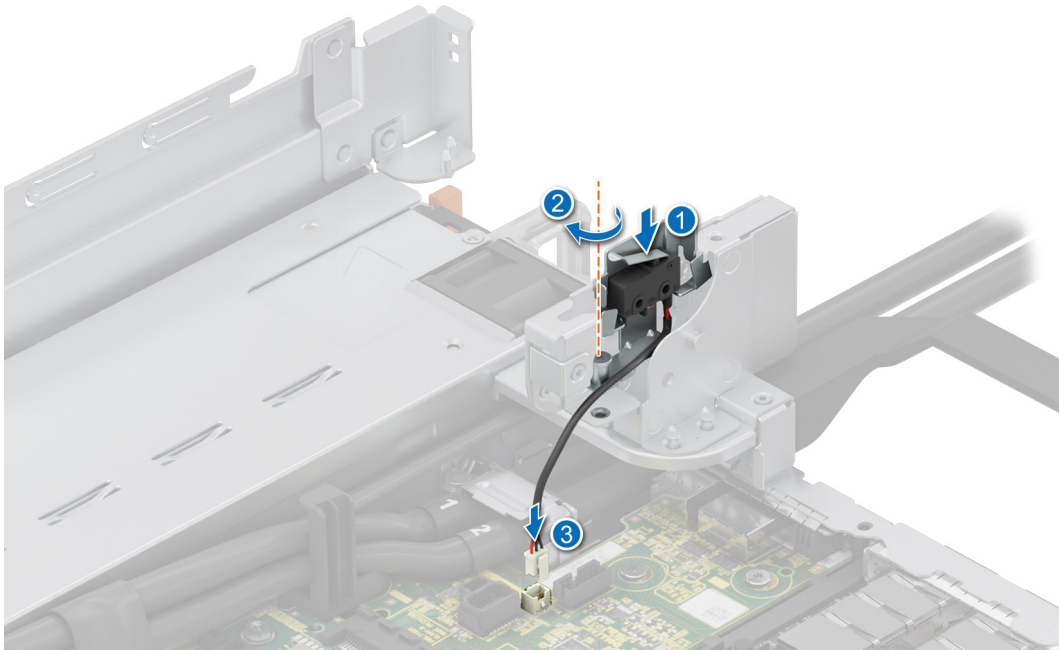


Figure 192. Installing the intrusion switch

### Next steps

1. [Install the air shroud.](#)
2. Follow the procedure listed in [After working inside your system.](#)

## Optional OCP card

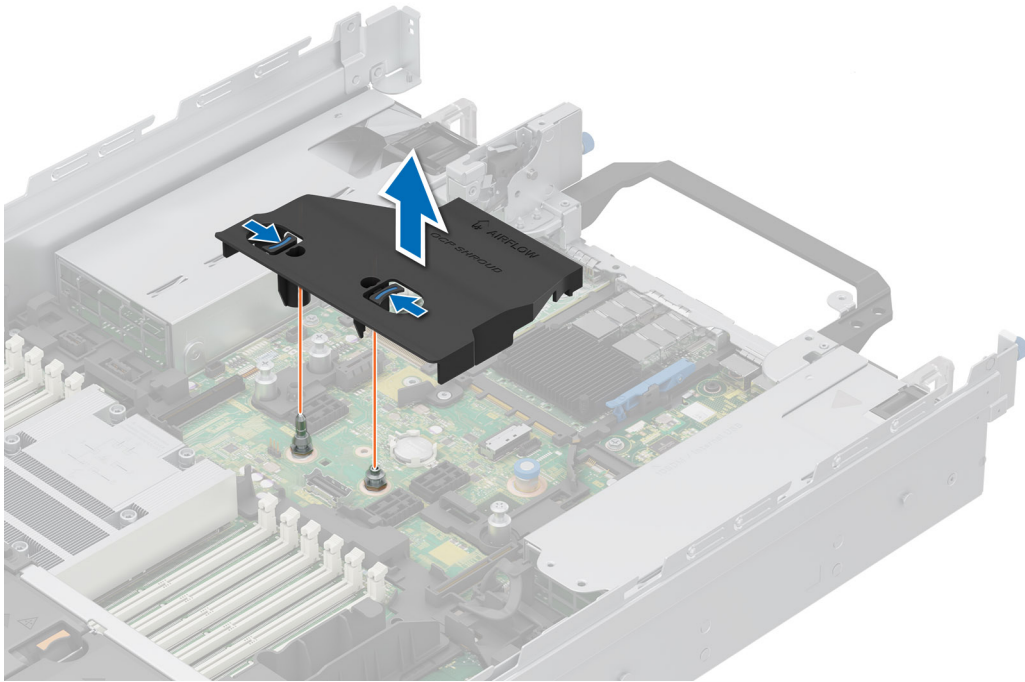
### Removing the OCP card shroud

#### Prerequisites

1. Follow the safety guidelines listed in the [Safety instructions.](#)
2. Follow the procedure listed in the [Before working inside your system.](#)
3. [Remove the expansion card riser.](#)

#### Steps

Hold the edges of the OCP shroud and lift the shroud out of the system.



**Figure 193. Removing the OCP shroud**

**Next steps**

1. [Replace the OCP card.](#)

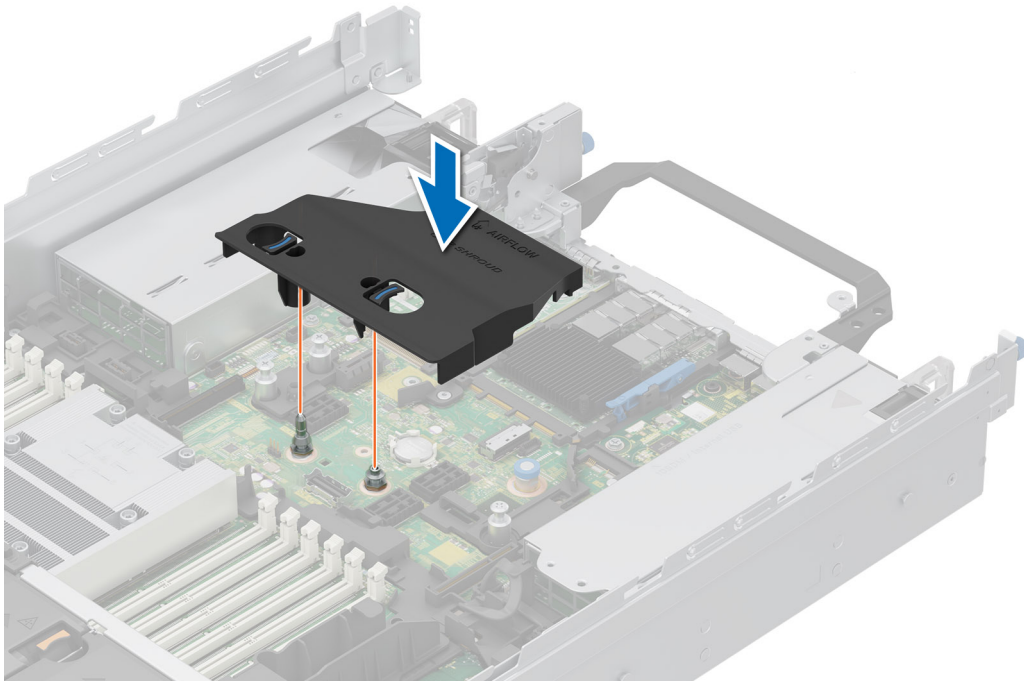
## Installing the OCP card shroud

**Prerequisites**

1. Follow the safety guidelines listed in the [Safety instructions](#).
2. Follow the procedure listed in the [Before working inside your system](#).
3. [Remove the expansion card riser.](#)

**Steps**

1. Align OCP card shroud with the slot on the system.
2. Lower and press the OCP shroud until it clicks into place.



**Figure 194. Installing the OCP card shroud**

#### **Next steps**

1. [Replace the OCP card.](#)

## **Removing the OCP card**

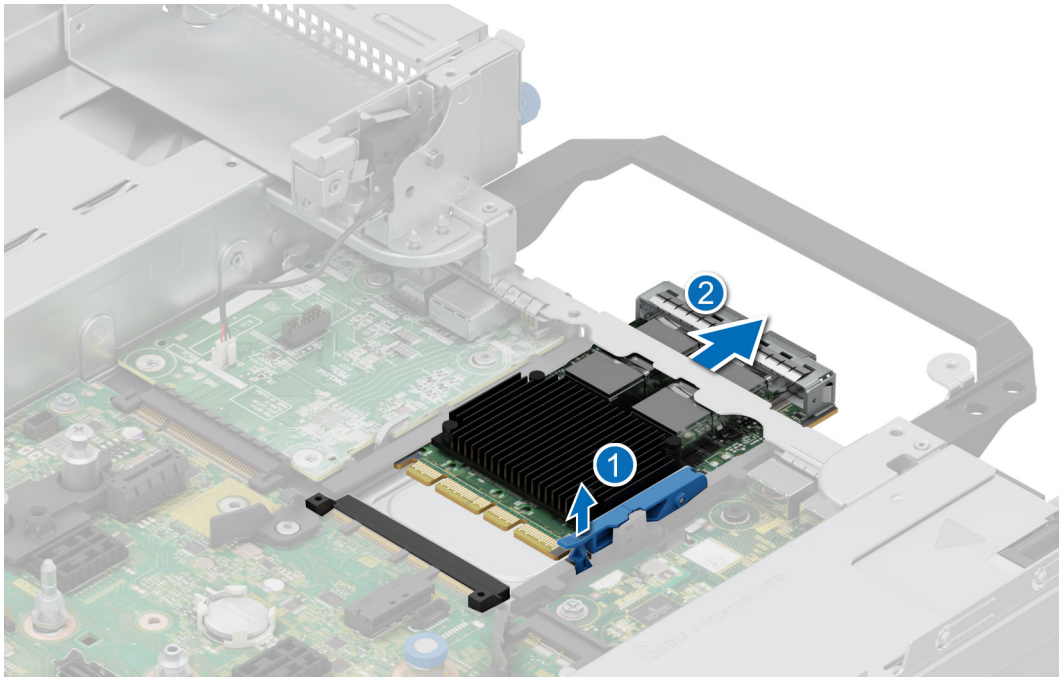
#### **Prerequisites**

1. Follow the safety guidelines listed in the [Safety instructions](#).
2. Follow the procedure listed in the [Before working inside your system](#).
3. [Remove the expansion card riser.](#)

#### **Steps**

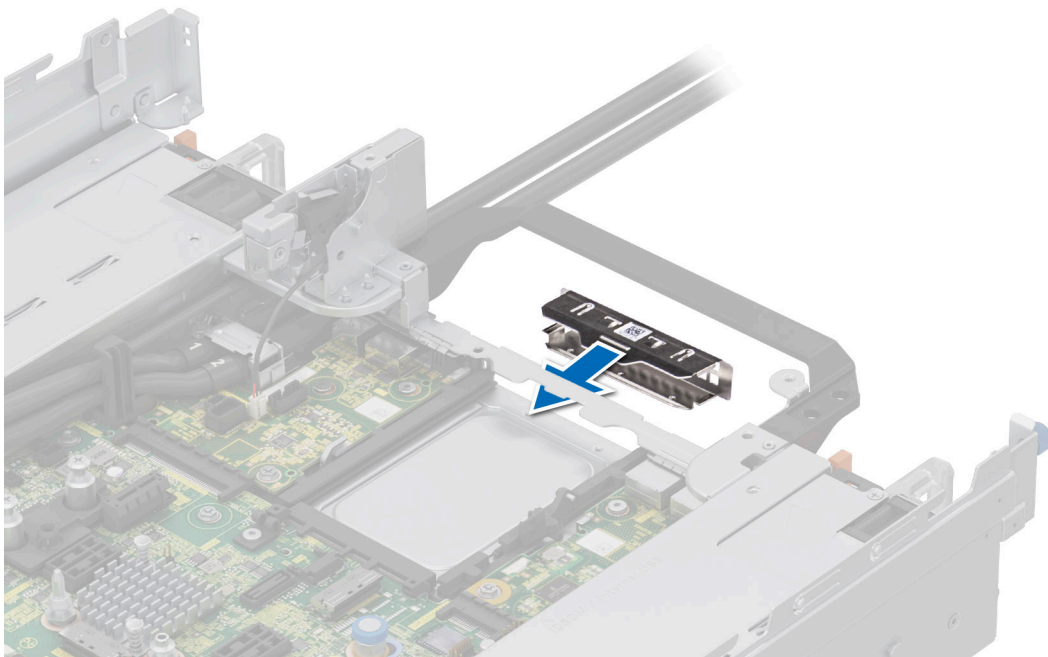
1. Open the blue latch to disengage the OCP card.
2. Push the OCP card towards the rear end of the system to disconnect from the connector on the system board.
3. Slide the OCP card out of the slot on the system.





**Figure 195. Removing the OCP card**

4. If the OCP card is not going to be replaced, install a filler bracket .



**Figure 196. Installation of filler bracket**

#### **Next steps**

1. Replace the OCP card.

# Installing the OCP card

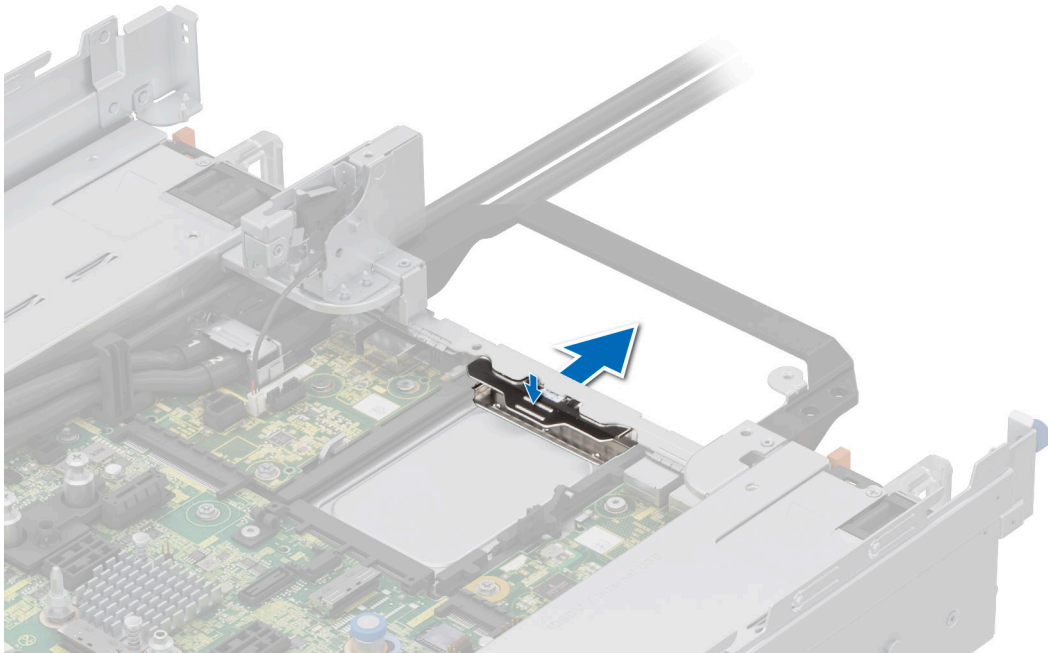
## Prerequisites

1. Follow the safety guidelines listed in the [Safety instructions](#).
2. Follow the procedure listed in the [Before working inside your system](#).
3. [Remove the expansion card riser](#).

**CAUTION:** Do not install GPUs, network cards, or other PCIe devices on your system that are not validated and tested by Dell. Damage caused by unauthorized and invalidated hardware installation will null and void the system warranty.

## Steps

1. If installed, remove the filler bracket.



**Figure 197. Removal of filler bracket**

2. Open the blue latch on the system board.
3. Slide the OCP card into the slot in the system.
4. Push until the OCP card is connected to the connector on the system board.
5. Close the blue latch to lock the OCP card to the system.

**NOTE:** The numbers on the image do not depict the exact steps. The numbers are for representation of sequence.

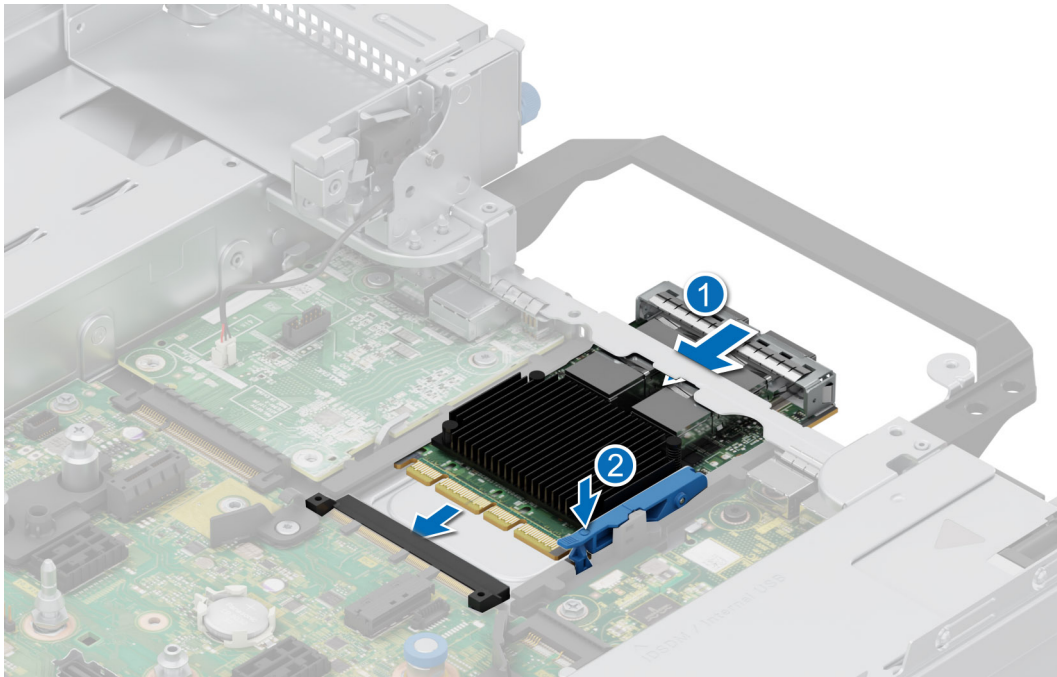


Figure 198. Installing the OCP card

#### Next steps

1. [Install the expansion card riser.](#)
2. Follow the procedure listed in [After working inside your system.](#)

## Power supply unit

**NOTE:** While replacing the hot swappable PSU, after next server boot; the new PSU automatically updates to the same firmware and configuration of the replaced one. For updating to the latest firmware and changing the configuration, see the *Lifecycle Controller User's Guide* at <https://www.dell.com/idracmanuals>.

**NOTE:** For information about DC PSU cabling instructions, go to <https://www.dell.com/poweredgemanuals> > **Rack Servers** > PowerEdge R7615 > **Select This Product** > **Documentation** > **Manuals and Documents** > *Cabling instructions for – 48 – 60 V DC power supply.*

## Hot spare feature

Your system supports the hot spare feature that significantly reduces the power overhead associated with the power supply unit (PSU) redundancy.

When the hot spare feature is enabled, one of the redundant PSUs is switched to the sleep state. The active PSU supports 100 percent of the system load, thus operating at higher efficiency. The PSU in the sleep state monitors output voltage of the active PSU. If the output voltage of the active PSU drops, the PSU in the sleep state returns to an active output state.

If having both PSUs active is more efficient than having one PSU in the sleep state, the active PSU can also activate the sleeping PSU.

The default PSU settings are as follows:

- If the load on the active PSU is more than 50 percent of PSU rated power wattage, then the redundant PSU is switched to the active state.
- If the load on the active PSU falls below 20 percent of PSU rated power wattage, then the redundant PSU is switched to the sleep state.

You can configure the hot spare feature by using the iDRAC settings. For more information, see the *iDRAC User's Guide* available at [www.dell.com/poweredgemanuals](http://www.dell.com/poweredgemanuals).

## Removing a power supply unit blank

### Prerequisites

Follow the safety guidelines listed in the [Safety instructions](#).

### Steps

Pull the blank out of the system.

**CAUTION:** To ensure proper system cooling, the PSU blank must be installed in the second PSU bay in a non-redundant configuration. Remove the PSU blank only if you are installing a second PSU.

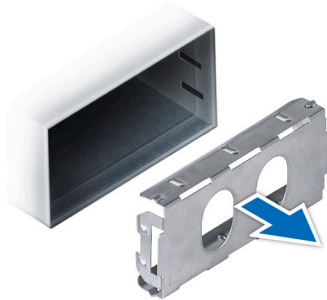


Figure 199. Removing a power supply unit blank

### Next steps

1. [Replace the PSU blank](#) or [install the PSU](#).

## Installing a power supply unit blank

### Prerequisites

1. Follow the safety guidelines listed in the [Safety instructions](#).  
**NOTE:** Install the power supply unit (PSU) blank only in the second PSU bay.
2. If required, [Remove the PSU](#).

### Steps

Align the PSU blank with the PSU bay and push it into the PSU bay until it clicks into place.

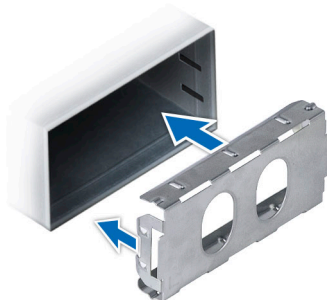


Figure 200. Installing a power supply unit blank

## Removing a power supply unit adapter blank

Remove the PSU adapter, when installing PSU with 86 mm wide form factor.

### Prerequisites

Follow the safety guidelines listed in the [Safety instructions](#).

### Steps

Using a Phillips #1 screwdriver, loosen the screw and remove the power supply unit adapter blank.

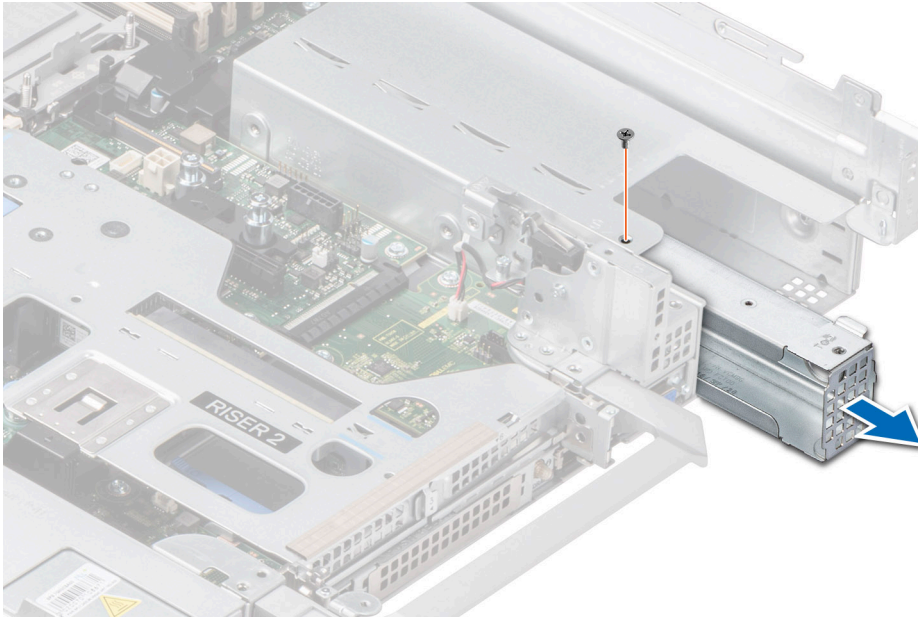


Figure 201. Removing a power supply unit adapter blank

### Next steps

1. [Replace the PSU adapter](#) or [Install the PSU](#).

## Installing a power supply unit adapter blank

### Prerequisites

1. Follow the safety guidelines listed in the [Safety instructions](#).
2. If required, [Remove the PSU](#).

**NOTE:** Remove the PSU adapter, when installing PSU with 86 mm wide form factor.

### Steps

1. Align and insert the power supply unit adapter blank.
2. Using a phillips #1 screwdriver, tighten the screw.

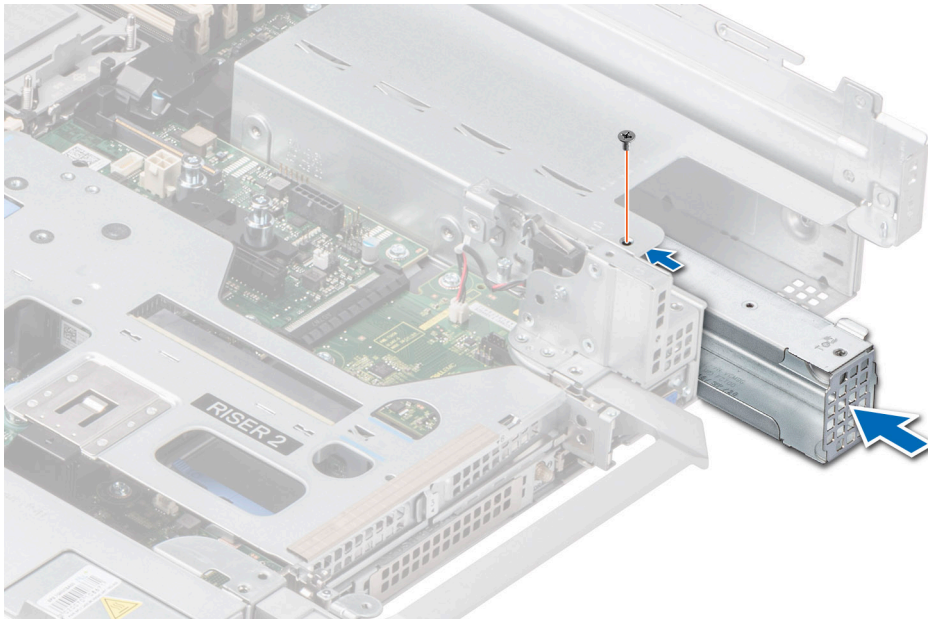


Figure 202. Installing a power supply unit adapter blank

## Removing a power supply unit

### Prerequisites

**CAUTION:** The system requires one power supply unit (PSU) for normal operation. On power-redundant systems, remove and replace only one PSU at a time in a system that is powered on.

1. Follow the safety guidelines listed in the [Safety instructions](#).
  2. Disconnect the power cable from the power outlet and from the PSU that you intend to remove.
  3. Remove the cable from the strap on the PSU handle.
  4. Unlatch and lift or remove the optional cable management accessory if it interferes with the PSU removal.
- NOTE:** For information about the cable management when the PSU is removed or installed while the system is in a rack, see the system's cable management arm documentation at <https://www.dell.com/poweredgemanuals>.

### Steps

Press the release latch and holding the PSU handle, slide the PSU out of the bay.



**Figure 203. Removing a power supply unit**

#### Next steps

1. [Replace the PSU](#) or [install the PSU blank](#).

## Installing a power supply unit

#### Prerequisites

1. Follow the safety guidelines listed in the [Safety instructions](#).
2. For systems that support redundant PSU, ensure that both the PSUs are of the same type and have the same maximum output power.

**i** **NOTE:** The maximum output power (shown in watts) is listed on the PSU label.

3. If required, [Remove the PSU blank](#).

#### Steps

Slide the PSU into the PSU bay until the release latch snaps into place.



Figure 204. Installing a power supply unit

#### Next steps

1. If you have unlatched or removed the cable management accessory, reinstall or relatch it. For information about the cable management when the PSU is removed or installed while the system is in the rack, see the system's cable management accessory documentation at <https://www.dell.com/poweredgemanuals>.
2. Connect the power cable to the PSU, and plug the cable into a power outlet.

**CAUTION:** When connecting the power cable to the PSU, secure the cable to the PSU with the strap.

**NOTE:** When installing hot swapping, or hot adding a new PSU, wait for 15 seconds for the system to recognize the PSU and determine its status. The PSU redundancy may not occur until discovery is complete. The PSU status indicator turns green to indicate that the PSU is functioning properly.

## Trusted Platform Module

### Upgrading the Trusted Platform Module

#### Removing the TPM

##### Prerequisites

**NOTE:**

- Ensure the operating system is compatible with the TPM version you are installing.
- Ensure that you download and install the latest BIOS firmware on your system.
- Ensure that the BIOS is configured to enable UEFI boot mode.

**CAUTION:** The TPM plug-in module is cryptographically bound to that particular system board after it is installed. When the system is powered on, any attempt to remove an installed TPM plug-in module breaks the cryptographic binding, and the removed TPM cannot be installed on another system board. Ensure any keys you have stored on the TPM have been securely transferred.



### Steps

1. Locate the TPM connector on the system board.
2. Press to hold the module down and remove the screw using the security Torx 8-bit shipped with the TPM module.
3. Slide the TPM module out from its connector.
4. Push the plastic rivet away from the TPM connector and rotate it 90° counterclockwise to release it from the system board.
5. Pull the plastic rivet out of its slot on the system board.

## Installing the TPM

### Steps

1. To install the TPM, align the edge connectors on the TPM with the slot on the TPM connector.
2. Insert the TPM into the TPM connector such that the plastic rivet aligns with the slot on the system board.
3. Press the plastic rivet until the rivet snaps into place.
4. Replace the screw that secures the TPM to the system board.

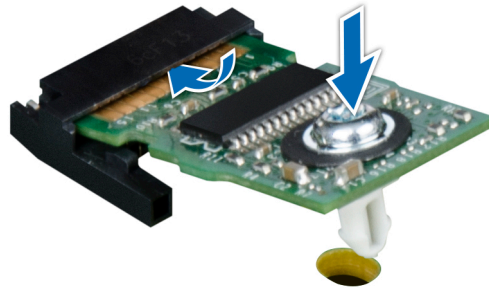


Figure 205. Installing the TPM

## Initializing TPM for users

### Steps

1. Initialize the TPM.  
For more information, see [Initializing the TPM for users](#).
2. The **TPM Status** changes to **Enabled, Activated**.

## Initializing the TPM 2.0 for users


### Steps

1. While booting your system, press F2 to enter System Setup.
2. On the **System Setup Main Menu** screen, click **System BIOS > System Security Settings**.
3. From the **TPM Security** option, select **On**.
4. Save the settings.
5. Restart your system.

# System board

## Removing the system board

### Prerequisites

 **CAUTION:** If you are using the Trusted Platform Module (TPM) with an encryption key, you may be prompted to create a recovery key during program or System Setup. Be sure to create and safely store this recovery key. If you replace this system board, you must supply the recovery key when you restart your system or program before you can access the encrypted data on your drives.

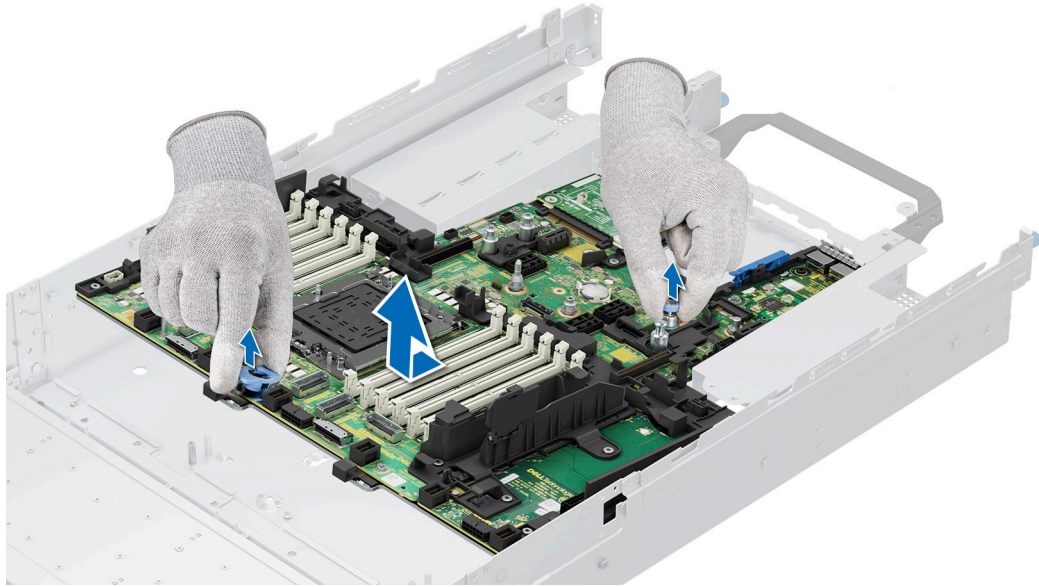
1. Follow the safety guidelines listed in the [Safety instructions](#).
2. Follow the procedure listed in the [Before working inside your system](#).
3. Remove the following components:
  - a. [Air shroud](#)
  - b. [Cooling fan cage assembly](#)
  - c. [Side wall bracket](#)
  - d. [Memory modules](#)
  - e. [Serial COM port \(if installed\)](#)
  - f. [VGA port \(if installed\)](#)
  - g. [Expansion card risers](#)
  - h. [Rear drive module](#)
  - i. [Processor and heat sink module](#)
  - j. [BOSS-N1 module](#)
  - k. [GPU air shroud \(if installed\)](#)
  - l. [Internal USB card \(if installed\)](#)
  - m. [OCP card \(if installed\)](#)
  - n. [LOM card \(if installed\)](#)
  - o. [Power supply units \(PSU\)](#)
  - p. Disconnect all the cables from the system board and make note of all the cable connections.

 **CAUTION:** Take care not to damage the system identification button while removing the system board from the system.

 **CAUTION:** Do not lift the system board by holding a memory module, processor, or other components.

### Steps

1. Using the system board holder and plunger, slide the system board towards the front of the system.
2. At a tilted angle, lift the system board out of the chassis.



**Figure 206. Removing the system board**

### Next steps

1. [Install the system board.](#)

## Installing the system board

### Prerequisites

**NOTE:** Before replacing the system board, replace the old iDRAC MAC address label in the Information tag with the iDRAC MAC address label of the replacement system board.

1. Follow the safety guidelines listed in the [Safety instructions](#).
2. Follow the procedure listed in [Before working inside your system](#).
3. If you are replacing the system board, remove all the components that are listed in the [removing the system board](#) section.

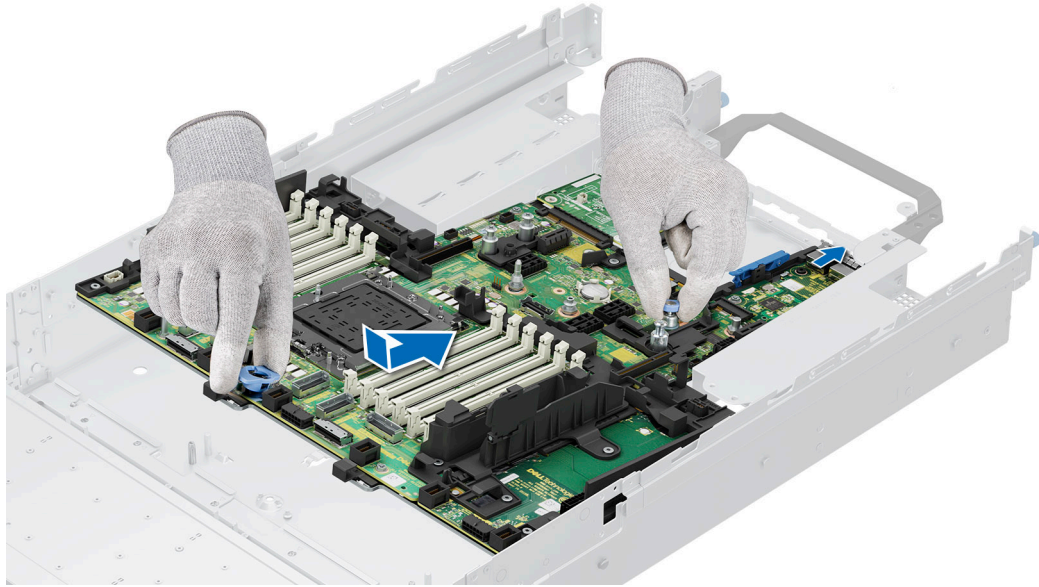
### Steps

1. Unpack the new system board assembly.

**CAUTION:** Do not lift the system board by holding a memory module, processor, or other components.

**CAUTION:** Take care not to damage the system identification button while placing the system board into the chassis.

2. Holding the system board holder and plunger, lower the system board at a tilted angle into the system.
3. Slide the system board towards the rear of the chassis until the connectors are firmly seated in the slots.



**Figure 207. Installing the system board**

### Next steps

1. Replace the following components:
  - a. [Trusted Platform Module \(TPM\)](#)
    - i** **NOTE:** The TPM Module must be replaced only while installing new system board.
  - b. [Internal USB card \(if removed\)](#)
  - c. [OCP card \(if removed\)](#)
  - d. [Processor and heat sink module](#)
  - e. [Memory modules](#)
  - f. [GPU air shroud \(if removed\)](#)
  - g. [Expansion card risers](#)
  - h. [Rear drive module](#)
  - i. [VGA port \(if removed\)](#)
  - j. [Serial COM port \(if removed\)](#)
  - k. [BOSS-N1 module](#)
  - l. [Side wall bracket](#)
  - m. [Cooling fan cage assembly](#)
  - n. [Air shroud](#)
  - o. [Power supply units \(PSU\)](#)
2. Reconnect all cables to the system board.
  - i** **NOTE:** Ensure that the cables inside the system are routed along the chassis wall and secured using the cable securing bracket.
3. Ensure that you perform the following steps:
  - a. Use the Easy Restore feature to restore the Service Tag. See the [Restoring the system by using the Easy Restore feature](#) section.
  - b. If the service tag is not backed up in the backup flash device, enter the system service tag manually. See the [Manually update the Service Tag by using System Setup](#) section.
  - c. Update the BIOS and iDRAC versions.
  - d. Re-enable the Trusted Platform Module (TPM). See the [Upgrading the Trusted Platform Module](#) section.
4. Follow the procedure listed in [After working inside your system](#).

## Restoring Service Tag using Easy Restore

The Easy Restore feature allows you to restore your Service Tag, iDRAC license, UEFI configuration, and the system configuration data after replacing the system board. All data is backed up in a backup Flash drive device automatically. If BIOS detects a new system board, and the Service Tag in the backup Flash drive device is different, BIOS prompts the user to restore the backup information.

### About this task

Below is a list of options available:

1. Restore the Service Tag, license, and diagnostics information, press **Y**.
  2. Go to the Lifecycle Controller based restore options, press **N**.
  3. Restore data from a previously created **Hardware Server Profile**, press **F10**.  
**i** **NOTE:** When the restore process is complete, BIOS prompts to restore the system configuration data.
  4. To restore the system configuration data, press **Y**
  5. To use the default configuration settings, press **N**  
**i** **NOTE:** After the restore process is complete, system reboots.
- i** **NOTE:** If restoring the Service Tag is successful, you can check the Service Tag information in the **System Information** screen and compare it with the Service Tag on the system.

## Manually update the Service Tag

After replacing a system board, if Easy Restore fails, follow this process to manually enter the Service Tag, using **System Setup**.

### About this task

If you know the system service tag, use the **System Setup** menu to enter the service tag.

### Steps

1. Power on the system.
2. To enter the **System Setup**, press **F2**.
3. Click **Service Tag Settings**.
4. Enter the service tag.  
**i** **NOTE:** You can enter the service tag only when the **Service Tag** field is empty. Ensure that you enter the correct service tag. Once the service tag is entered, it cannot be updated or changed. Incorrectly entered service tag will lead to system board replacement.
5. Click **OK**.

## LOM card and rear I/O board

### Removing the LOM card and rear I/O board

#### Prerequisites

1. Follow the safety guidelines listed in the [Safety instructions](#).
2. Follow the procedure listed in the [Before working inside your system](#).
3. [Remove the system board](#).  
**i** **NOTE:** The procedure to remove the liquid cooling rear I/O board and rear I/O boards is same.

### Steps

1. Using a Phillips # 2 screwdriver, remove the screws that secure the LAN on Motherboard (LOM) card and rear I/O board to the system board.
2. Holding the edges, pull the LOM card or rear I/O board to disconnect from the connector on the system board.

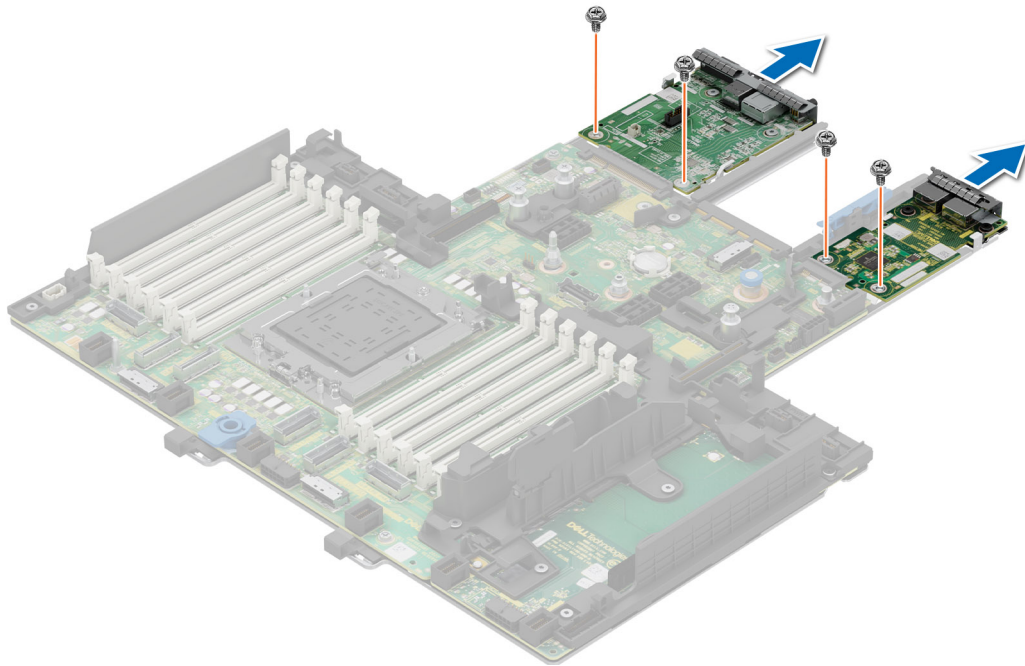


Figure 208. Removing the LOM card and rear I/O board

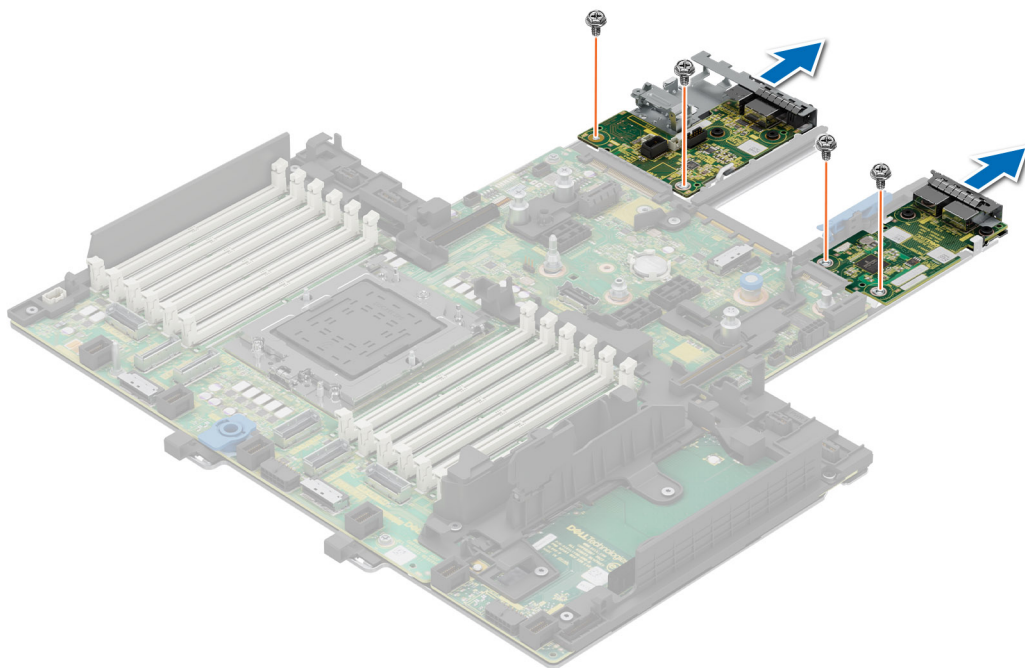


Figure 209. Removing the LOM card and liquid cooling rear I/O board

### Next steps

1. Replace the LOM card and rear I/O board.

# Installing the LOM card and rear I/O board

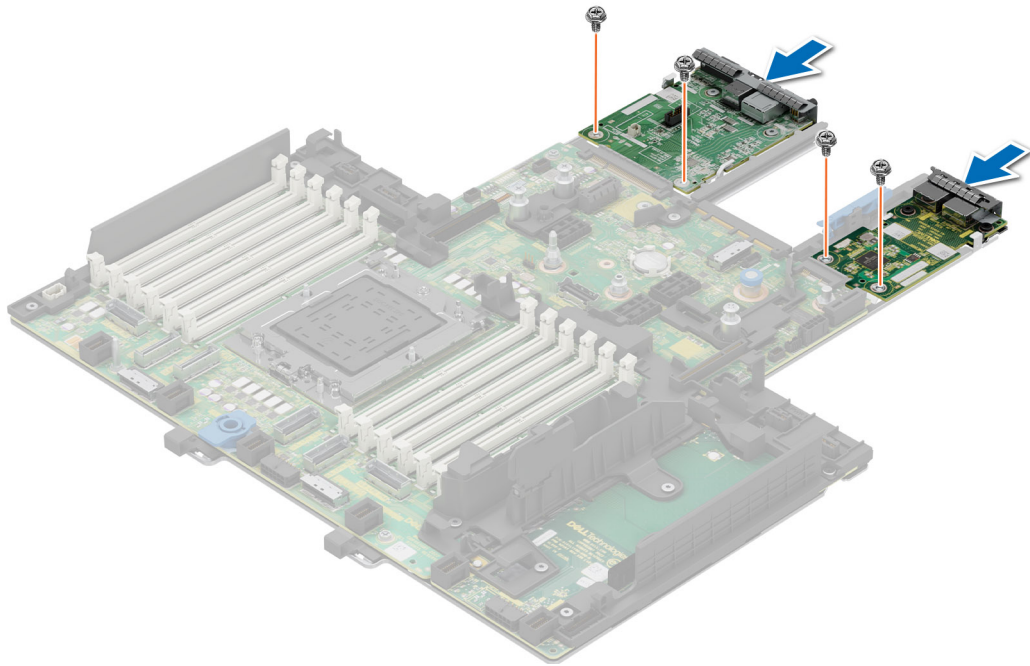
## Prerequisites

1. Follow the safety guidelines listed in the [Safety instructions](#).
2. Follow the procedure listed in the [Before working inside your system](#).
3. [Remove the system board](#).

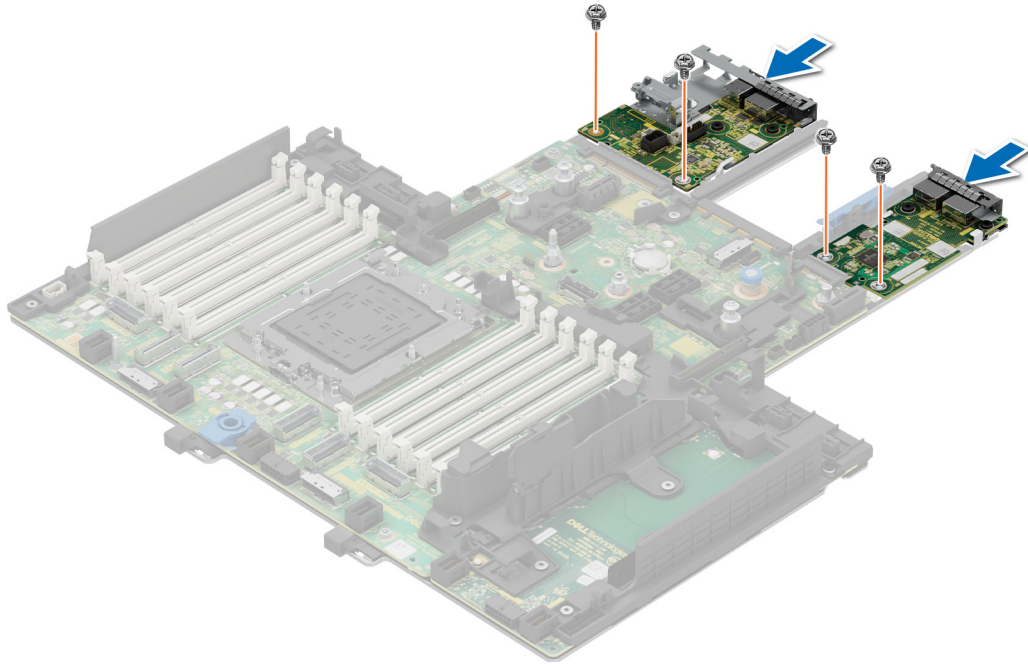
**i** **NOTE:** The procedure to install the liquid cooling rear I/O board and rear I/O boards is same.

## Steps

1. Align the connectors and slots on the LOM card or rear I/O board with the connector and standoffs on the system board.
2. Press the LOM card or rear I/O board until firmly seated on the system board connector.
3. Using a Phillips #2 screwdriver, secure the LOM card or rear I/O board to the system board with screws.



**Figure 210. Installing the LOM card and rear I/O board**



**Figure 211. Installing the LOM card and Liquid cooling rear I/O board**

#### Next steps

1. [Install the system board.](#)
2. Follow the procedure listed in [After working inside your system.](#)

## Control panel

This is a service technician replaceable part only.

## Removing the right control panel

#### Prerequisites

1. Follow the safety guidelines listed in the [Safety instructions.](#)
2. Follow the procedure listed in the [Before working inside your system.](#)
3. [Remove the drive backplane cover.](#)
4. If installed, [remove the air shroud.](#)
5. [Remove the cooling fan cage assembly.](#)
6. [Remove the side wall bracket.](#)

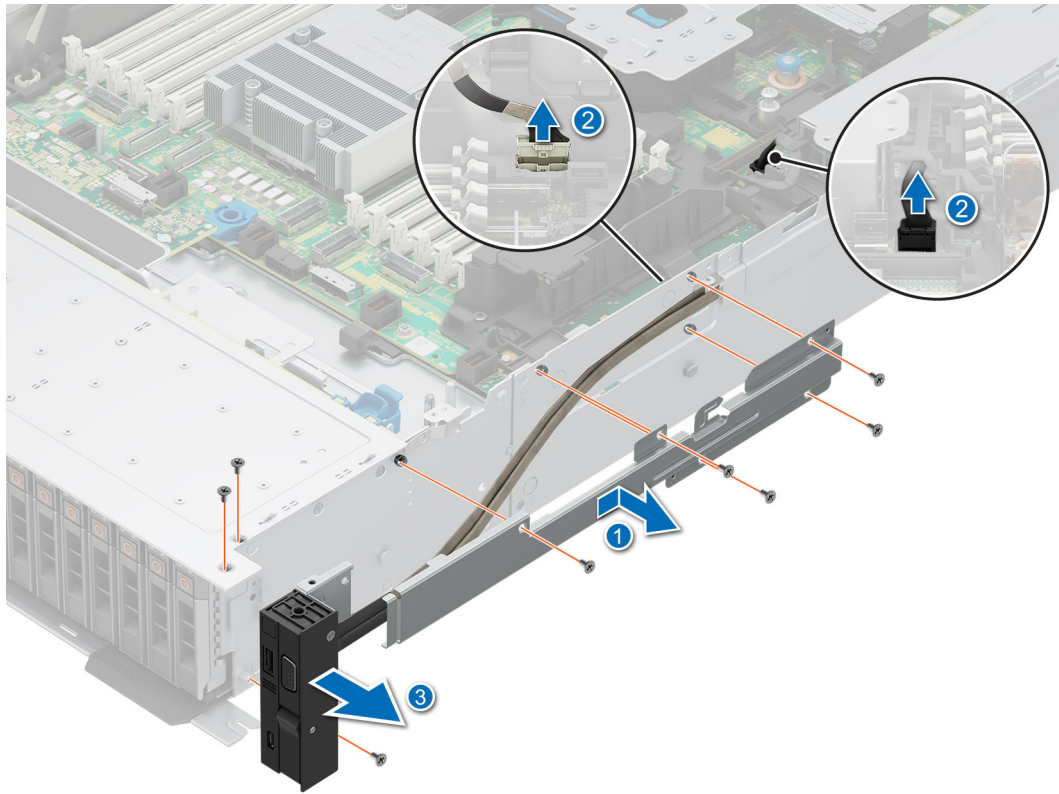
#### Steps

1. Using the Phillips #1 screwdriver, remove the screws that secure the right control panel and cable cover to the system.
2. Remove the cable cover away from the system.
3. Disconnect the right control panel cable and the VGA cable from the connectors on the system board.
4. Holding the right control panel and VGA cable assembly, slide the right control panel out of the system.

**i** **NOTE:** Observe the routing of the cable assembly as you remove the right control panel from the system.

**i** **NOTE:** The numbers on the image do not depict the exact steps. The numbers are for representation of sequence.





**Figure 212. Removing the right control panel**

#### Next steps

1. Replace the right control panel.

## Installing the right control panel

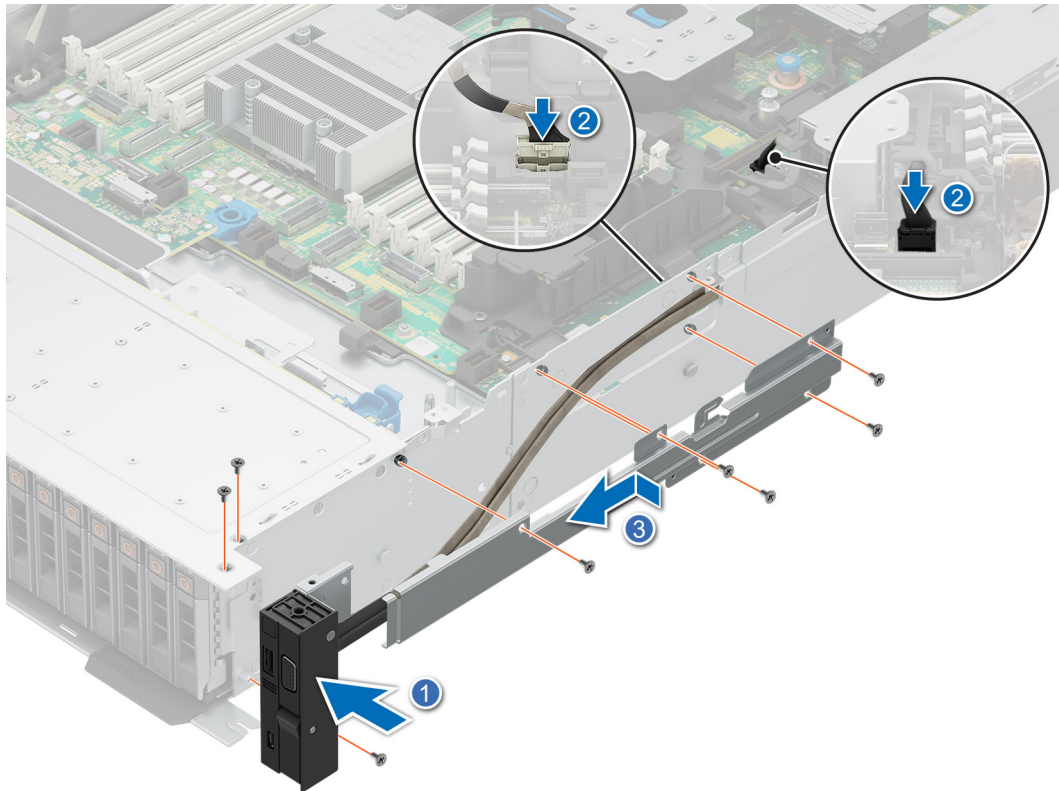
#### Prerequisites

1. Follow the safety guidelines listed in the [Safety instructions](#).
2. Follow the procedure listed in the [Before working inside your system](#).
3. [Remove the drive backplane cover](#).
4. If installed, [remove the air shroud](#).
5. [Remove the cooling fan cage assembly](#).
6. [Remove the side wall bracket](#).

#### Steps

1. Align and slide the right control panel into the slot on the system.
  2. Route the right control panel cable through the side wall of the system.
  3. Align and slide the right control panel cable cover in the slot on the system.
- NOTE:** Route the cable properly to prevent the cable from being pinched or crimped.
4. Connect the right control panel cable and VGA cable to the connectors on the system board.
  5. Using the Phillips #1 screwdriver, tighten the screws that secure the right control panel and the cable cover to the system.

**NOTE:** The numbers on the image do not depict the exact steps. The numbers are for representation of sequence.



**Figure 213. Installing the right control panel**

#### Next steps

1. Install the side wall bracket.
2. Install the cooling fan cage assembly.
3. Install the drive backplane cover.
4. If removed, install the air shroud.
5. Follow the procedure listed in [After working inside your system](#).

## Removing the left control panel

#### Prerequisites

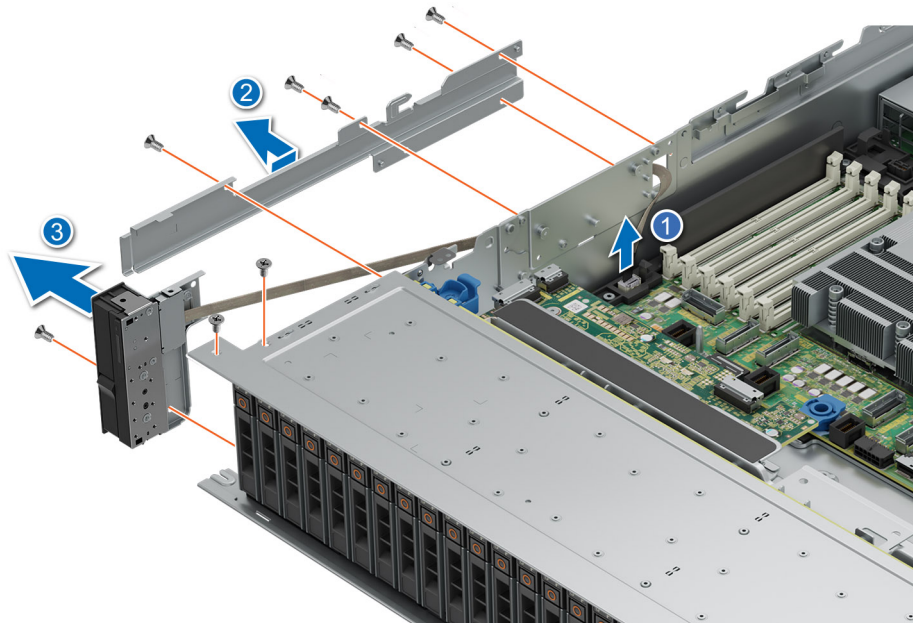
1. Follow the safety guidelines listed in the [Safety instructions](#).
2. Follow the procedure listed in the [Before working inside your system](#).
3. [Remove the drive backplane cover](#).
4. If installed, [remove the air shroud](#).
5. [Remove the cooling fan cage assembly](#).
6. [Remove the side wall bracket](#).

#### Steps

1. Using the Phillips #1 screwdriver, remove the screws that secure the left control panel and the cable cover to the system.
2. Remove the cable cover away from the system.
3. Disconnect the control panel cable from the connector on the system board.
4. Holding the cable, slide the left control panel out of the system.

**NOTE:** Observe the routing of the cable as you remove the right control panel from the system.

**NOTE:** The numbers on the image do not depict the exact steps. The numbers are for representation of sequence.



**Figure 214. Removing the left control panel**

#### Next steps

1. [Replace the left control panel.](#)

## Installing the left control panel

#### Prerequisites

1. Follow the safety guidelines listed in the [Safety instructions](#).
2. Follow the procedure listed in the [Before working inside your system](#).
3. [Remove the drive backplane cover.](#)
4. If installed, [remove the air shroud.](#)
5. [Remove the cooling fan cage assembly.](#)
6. [Remove the side wall bracket.](#)

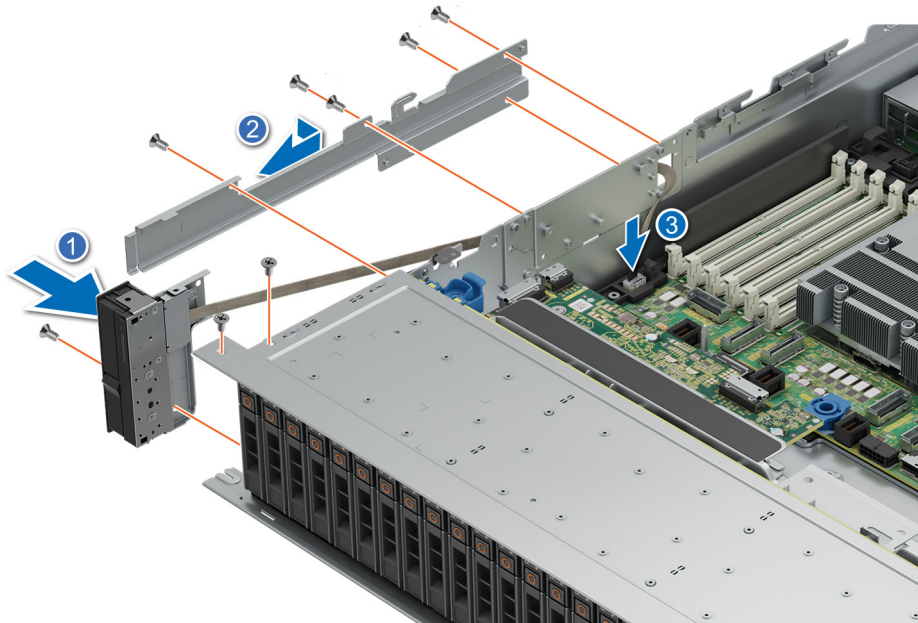
#### Steps

1. Align and slide the left control panel in the slot on the system.
2. Route the left control panel cable through the side wall of the system.
3. Align and slide the left control panel cable cover in the slot on the system.

**NOTE:** Route the cable properly to prevent the cable from being pinched or crimped.

4. Connect the left control panel cable to the connector on the system board .
5. Using the Phillips #1 screwdriver, tighten the screws to secure the left control panel and the cable cover to the system.

**NOTE:** The numbers on the image do not depict the exact steps. The numbers are for representation of sequence.



**Figure 215. Installing the left control panel**

**Next steps**

1. [Install the side wall bracket.](#)
2. [Install the cooling fan cage assembly.](#)
3. [Install the drive backplane cover.](#)
4. If removed, [install the air shroud.](#)
5. Follow the procedure listed in [After working inside your system.](#)

# Upgrade Kits

The table lists the available After Point Of Sale [APOS] kits.

**Table 111. Upgrade kits**

Kits	Related links to service instructions
Bezel	See <a href="#">Installing the front bezel</a>
BOSS-N1	See <a href="#">Installing the BOSS-N1 controller card module</a>
GPU/Accelerator enablement kit	See <a href="#">GPU kit</a>
Drives	See <a href="#">Installing the drive</a>
Memory	See <a href="#">Installing a memory module</a>
Network cards (Standard PCIe adapter LP/FH)	See <a href="#">Installing the LOM card and rear I/O board</a>
Network cards (OCP)	See <a href="#">Installing the OCP card</a>
PCIe SSD card	See <a href="#">Installing the drive</a>
Power cords	N/A
Power supplies	See <a href="#">Installing a power supply unit</a>
Quick sync	N/A
TPM	See <a href="#">Upgrading the Trusted Platform Module</a>
Processor enablement thermal kits	See <a href="#">Installing the processor</a>
Internal USB 3.0 card	See <a href="#">Internal USB card kit</a>
Serial COM port daughter card	See <a href="#">Installing the serial COM port</a>
VGA port for Inrect Liquid Cooling system	See <a href="#">Installing the VGA port</a>
Cables	N/A
Fans	See <a href="#">Installing a fan</a>
Heat sink	See <a href="#">Installing a processor heat sink module</a>
Risers	See <a href="#">Installing the expansion riser</a>
Rail	N/A
CMA	N/A

## Topics:

- [BOSS-N1 module kit](#)
- [GPU kit](#)
- [Internal USB card kit](#)
- [Serial COM port kit](#)
- [VGA port kit](#)

## BOSS-N1 module kit

The BOSS-N1 module supports up to two M.2 SSDs.

**NOTE:** To enable the BOSS-N1 module in the system, ensure that the BIOS firmware version is 1.5.5 and iDRAC firmware version is 4.30.30.30 or later.

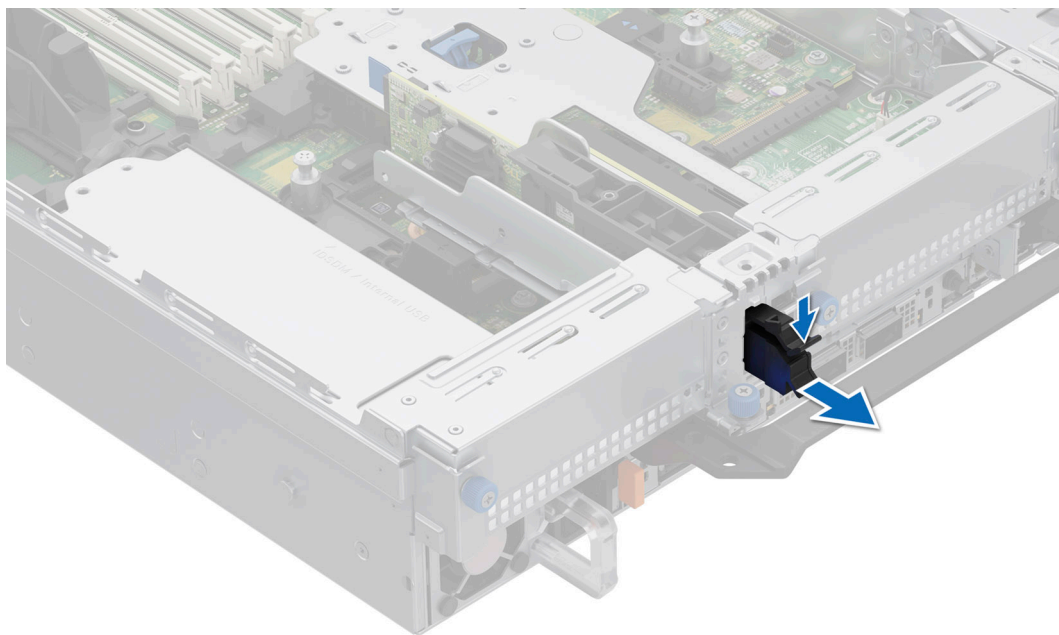
Before you begin the installation or removal process, follow the [safety guidelines](#) and [before working inside the system](#) instructions.

**Table 112. BOSS-N1 module kit components**

R760 (quantity)	Components in kit
NA	BOSS cover
1	M3 x 0.05 x 4.5 mm screws
1	BOSS signal cable
1	BOSS power cable
1	BOSS-N1 module
1 or 2	BOSS-N1 card carrier
1 or 2	M.2 SSD
2	M.2 240 GB information label
2	M.2 480 GB information label
1	BOSS card filler
1	Tech sheet

To remove the BOSS blank :

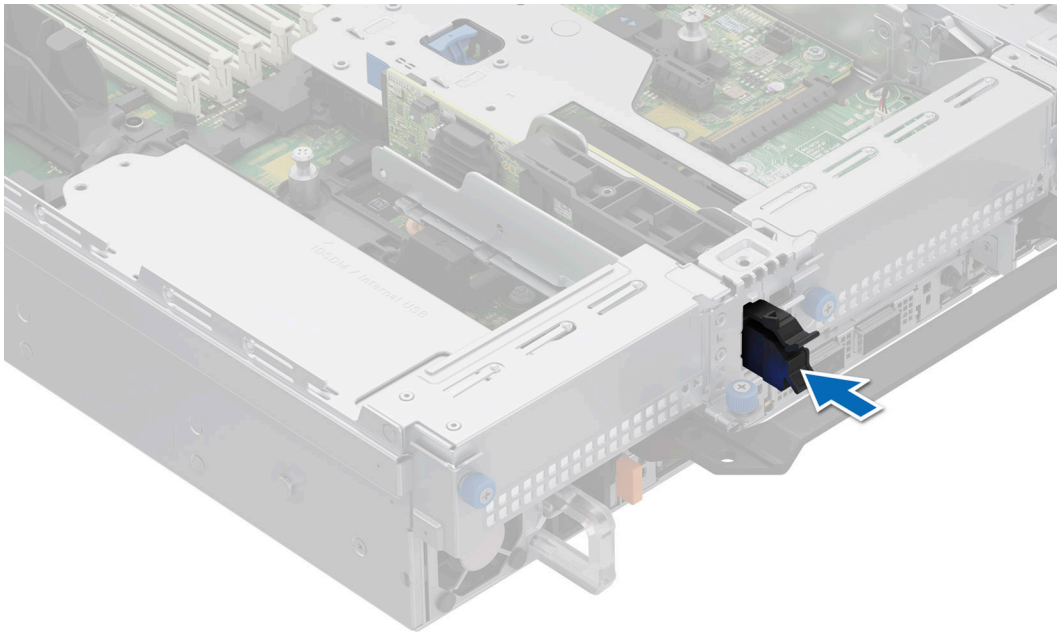
1. Power off the system and [remove the system cover](#).
2. Use a screwdriver to push out the blank from the BOSS-N1 module bay.



**Figure 216. Removing the BOSS-N1 module blank**

To install the BOSS blank:

1. Align the blank with the BOSS-N1 module bay and push it into the bay until it clicks into place.



**Figure 217. Installing the BOSS-N1 module blank**

To install the BOSS-N1 module:

1. Install the BOSS-N1 module . To install the BOSS-N1 , see [installing the BOSS-N1 module](#).
2. Install the M.2 SSD. To install the M.2 SSD, see [installing the BOSS-N1 module](#).

**i** **NOTE:** Installing the BOSS-N1 card carrier does not require the system to be powered off. System shutdown is only required when installing the BOSS-N1 controller card module.

To remove the BOSS-N1 module:

1. Power off the system and [remove the system cover](#).
2. Remove the M.2 SSD. To remove the M.2 SSD, see [Removing the BOSS-N1 module](#).
3. Remove the BOSS-N1 module. To remove the BOSS-N1 controller card module, see [Removing the BOSS-N1 module](#).
4. Install the BOSS-N1 module blank.

**i** **NOTE:** Removal of the BOSS-N1 card carrier does not require the system to be powered off. System shutdown is only required when removing the BOSS-N1 module.

**i** **NOTE:** Disconnect the BOSS signal cable and the BOSS power cable before lifting the module from the system.

# GPU kit

The GPU FL kit is available for the Customer. Depending on the kit ordered, the respective components are available.

**CAUTION:** Do not install GPUs, network cards, or other PCIe devices on your system that are not validated and tested by Dell. Damage caused by unauthorized and invalidated hardware installation will null and void the system warranty.

**WARNING:** Consumer-Grade GPU should not be installed or used in the Enterprise Server products.

**Table 113. Components in the full length (FL) GPU kit**

Components	GPU FL kit	
	Details	Quantity
Risers	Riser configuration (RC) 3-2, 5-2*, or, 10-2*	RC 3-2: R1P^ (FL) + R2A (HL) + R3B (HL) + R4P^ (FL) RC 5-2: R1R (FL) + R2A (HL) + R3A (FL) + R4P^ (FL) RC 10-2: R1P^ (FL) + R2A (HL) + R4R (FL)
Shroud	GPU shroud	1
Fans	HPR GOLD fan	6
Heat sinks	L-type heat sink for processor 1 and processor 2	RC 3-2, 5-2: 2 RC 10-2: 1
Cables	Power cable	2 x 4 (8-position) or 2 x 6 + 1 x 4 (12-position + 4-sideband)

FL - Full Length, HL - Half Length, HPR - High Performance, RC - Riser configuration

**NOTE:** See [expansion card installation guidelines](#) for more information about riser configuration supported for the system.

**NOTE:** ^ R1P and R4P supports Double Width (DW) GPU.

**NOTE:** \* The configuration 5-2 supports DW GPU only on slots 7 and configuration 10-2 supports DW GPU only on slot 2.

**NOTE:** All GPU cards require L-type heat sink and GPU shroud, irrespective of the length. However, the cooling fan and foam are dependent on different configurations which is shown in below table.

Before you begin, follow the **safety guidelines** and **before working inside the system** instructions.

1. Remove the standard or High Performance Silver (HPR) cooling fans and install the High performance Gold (VHP) cooling fans.

**NOTE:** See the cooling fan and foam requirement matrix for the cooling fan and foam requirement for different configurations.

**Table 114. Cooling fan and foam requirement matrix**

System configuration	Cooling fan	Foam requirement
	w/GPU	w/GPU
8 x 2.5-inch NVMe	HPR GOLD	No
8 x 2.5-inch NVMe + 8 x 2.5-inch SAS/SATA	HPR GOLD	Yes
16 x 2.5-inch SAS/SATA	HPR GOLD	Yes
16 x 2.5-inch NVMe	HPR GOLD	No
24 x 2.5-inch SAS/SATA	HPR GOLD	Yes
16 x 2.5-inch SAS/SATA + 8 x 2.5-inch NVMe	HPR GOLD	Yes



**Table 114. Cooling fan and foam requirement matrix (continued)**

System configuration	Cooling fan	Foam requirement
	w/GPU	w/GPU
24 x 2.5-inch NVMe	HPR GOLD	No
<b>i</b> <b>NOTE:</b> HPR GOLD fans also known as High performance Gold (VHP) fans.		

**i** **NOTE:** For more information about supported cooling fans matrix, see the [thermal restriction matrix](#) section.

**i** **NOTE:** 12 x 3.5-inch and rear drive configuration systems do not support GPU card.

- Remove the heat sink and install the required L-type heat sink.

**i** **NOTE:** All GPU cards require L-type heat sink and GPU shroud, irrespective of the length.

- Remove the air shroud and install the GPU air shroud.

- Remove the GPU air shroud top cover.

**i** **NOTE:** The GPU air shroud top cover is part of the GPU air shroud.

- Remove the GPU air shroud filler.

- Install the GPU into full length risers.

**i** **NOTE:** See [full length expansion card riser](#) into the system.

**i** **NOTE:** For information about riser slot location on the system board, see the System board jumpers and connectors topic.

- If applicable, connect the power cables to the GPU. To know the connectors for GPU on the system board, see the System board jumpers and connectors topic.

See the GPU power cable matrix to know about the requirement of cable for the GPU.

**Table 115. GPU power cable matrix**

Category	Supported GPUs	Type	Vendor	Cable	Cable quantity
GPU	NVIDIA A2	HL (FH and LP brackets)	NVIDIA	Not required	Not required
GPU	NVIDIA A30, A40, A16, and A100	FH and FL	NVIDIA	2 x 4 (8-position)	1 piece per GPU riser
GPU	NVIDIA H100	FH and FL	NVIDIA	2 x 6 + 1 x 4 (12-position + 4-sideband)	1 piece per GPU riser
HL - Half Length, FH - Full Height, FL - Full Length					

**i** **NOTE:** Maximum of two double width GPUs with power cables or a maximum of eight single width GPUs are supported in a system.

- Install the [full length expansion card riser](#) or [half height expansion card riser](#). See GPU kit components table for supported GPU risers.

- Install the GPU air shroud filler.

- Install the GPU air shroud top cover.

- Install the foam on the system cover. To install the foam,
  - Place the system cover with the System Information Label (SIL) side facing up.
  - For easier handling, peel off a small section of the adhesive cover and align the foam with the system cover.
  - Remove rest of the adhesive cover, and install foam on the system cover.
  - Press along the length of the foam to ensure that it is firmly affixed to the system cover.



**Figure 218. Installing Mylar foam on the system cover**

After installing, follow the [After working inside the system](#) instructions.

# Internal USB card kit

The internal USB card kit contains one internal USB card. For installation of internal USB card, see [installing the internal USB card](#) section.

**NOTE:** Ensure to install the internal USB card in the IDSDM/USB card port and not in the J\_R3\_PCIE\_PWR connector port.

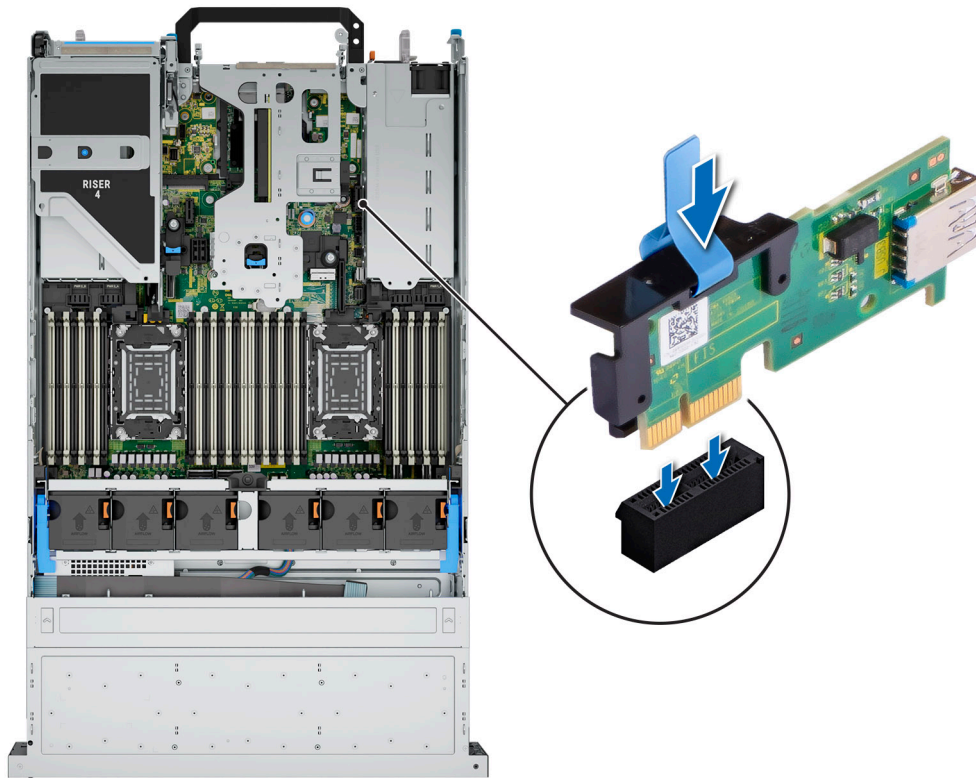


Figure 219. Internal USB card port information

# Serial COM port kit

The serial COM port kit contains the components that are listed in the table.

Table 116. Serial COM port kit

Components	Quantity
Serial COM port card	1
Cable	1

For installation procedure of the serial COM port, see [serial COM port](#) section.

# VGA port kit

The VGA port kit contains the components that are listed in the table.

**Table 117. VGA port kit**

<b>Components</b>	<b>Quantity</b>
VGA port card	1
Cable	1

For installation procedure of the VGA port, see [VGA port section](#).

# Jumpers and connectors

This section provides essential and specific information about jumpers and switches. It also describes the connectors on the various boards in the system. Jumpers on the system board help to disable the system and reset the passwords. To install components and cables correctly, you must be able to identify the connectors on the system board.

**Topics:**

- System board connectors
- System board jumper settings
- Disabling a forgotten password

## System board connectors

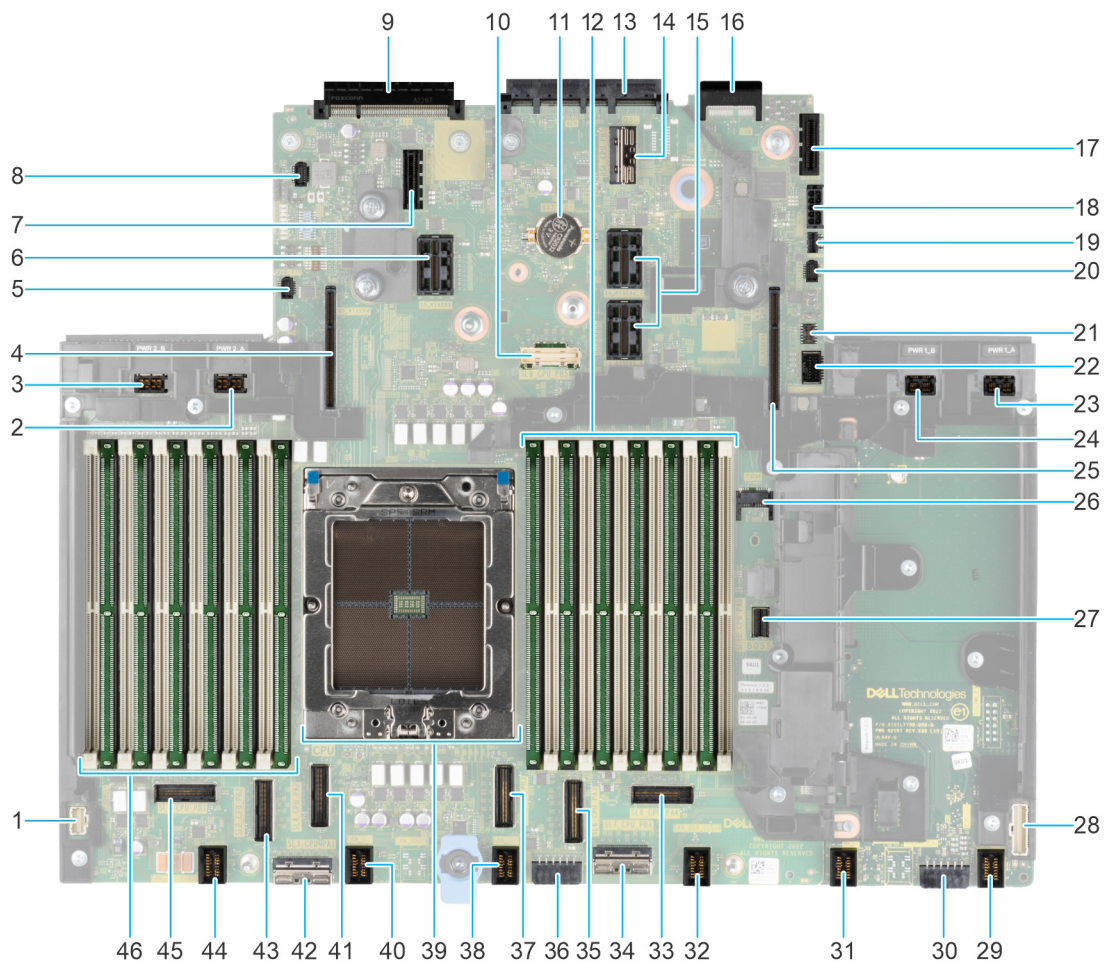


Figure 220. System board connectors

Table 118. System board jumpers and connectors

Item	connector	Description
1.	Left Control Panel connector	Left Control Panel connector

**Table 118. System board jumpers and connectors (continued)**

<b>Item</b>	<b>connector</b>	<b>Description</b>
2.	PWR_2_A	Power connector 0
3.	PWR_2_B	Power connector 1
4.	IO_RISER4	Riser 4
5.	PUCK_PSU2	PSU 2 PUCK Sideband Signal
6.	IO_RISER3	Riser 3
7.	J_R3_PCIE_PWR	Riser 3 power connector
8.	Battery SIG connector	Battery SIG connector
9.	Rear_I/O_connector	Rear_I/O_connector
10.	SL9_CPU_PB5	PCIe connector
11.	Coin Cell	Coin Cell
12.	A1, A5, A3, A9, A7, A11	DIMMs for CPU 1
13.	OCP	OCP NIC 3.0 connector
14.	DSL_CPU_PB5	PCIe connector
15.	IO_RISER2_A and IO_RISER2_B	Riser 2
16.	LOM Conenctor	LOM connector
17.	IDSDM or Internal USB connector	IDSDM or Internal USB connector
18.	SIG_PWR_0	Power connector 0 - use for rear BP only
19.	BOSS Card Power	BOSS card Power
20.	PUCK_PSU1	PSU 1 PUCK Sideband Signal
21.	Jumper PWR1_B	Jumper
22.	Front VGA connector	Front VGA connector
23.	PWR1_A	For Riser 1 GPU power and signal cable
24.	PWR1_B	For Riser 1 GPU power and signal cable
25.	IO_RISER1	Riser 1
26.	TPM	TPM connector
27.	SL10_CPU_PA6	PCIe connector 10
28.	Right Control Panel connector	Right Control Panel connector
29.	FAN_2U4	Fan 4 connector
30.	SIG_PWR_2	Power connector 2 - use for BP only
31.	FAN_2U5	Fan 5 connector
32.	FAN_2U4	Fan 4 connector
33.	SL8_CPU_PA4	PCIe connector 8
34.	SL7_CPU_PB4	PCIe connector 7
35.	SL6_CPU_PA3	PCIe connector 6
36.	SIG_PWR_1	Power connector 1 -use for BP only
37.	SL5_CPU_PB3	PCIe connector 5
38.	FAN_2U3	Fan 3 connector



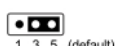

**Table 118. System board jumpers and connectors (continued)**

Item	connector	Description
39.	CPU	Processor
40.	FAN_2U2	Fan 2 connector
41.	SL4_CPU_PA2	PCIe connector 4
42.	SL3_CPU_PA1	PCIe connector 3
43.	SL2_CPU_PB2	PCIe connector 2
44.	FAN_2U1	Fan 1 connector
45.	SL1_CPU_PB1	PCIe connector 1
46.	A12, A8, A10, A4, A6, A2	DIMMs for CPU 1

## System board jumper settings

For information about resetting the password jumper to disable a password, see the [Disabling a forgotten password](#) section.

**Table 119. System board jumper settings**

Jumper	Setting	Description
PWRD_EN	 2 4 6 (default)	The BIOS password feature is enabled.
	 2 4 6	The BIOS password feature is disabled. The BIOS password is now disabled and you are not allowed to set a new password.
NVRAM_CLR	 1 3 5 (default)	The BIOS configuration settings are retained at system boot.
	 1 3 5	The BIOS configuration settings are cleared at system boot.

**CAUTION:** Be careful when changing the BIOS settings. The BIOS interface is designed for advanced users. Any change in the setting could prevent your system from starting correctly and you might have potential loss of data.

## Disabling a forgotten password

The software security features of the system include a system password and a setup password. The password jumper enables or disables password features and clears any password(s) currently in use.

### Prerequisites

**CAUTION:** Many repairs may only be done by a certified service technician. You should only perform troubleshooting and simple repairs as authorized in your product documentation, or as directed by the online or telephone service and support team. Damage due to servicing that is not authorized by Dell is not covered by your warranty. Read and follow the safety instructions that are shipped with your product.

### Steps

1. Power off the system, and all the attached peripherals, and disconnect the system from the electrical outlet.
2. Remove the system cover.
3. Replace the system cover.

4. Reconnect the system and all the attached peripherals.
5. Power off the system.
6. Remove the system cover.
7. Replace the system cover.
8. Reconnect the system to the electrical outlet and power on the system, and all the attached peripherals.
9. Assign a new system and/or setup password.




# System diagnostics and indicator codes

This section describes the diagnostic indicators on the system front panel that displays the system status during system startup.

## Topics:

- [Status LED indicators](#)
- [System health and system ID indicator codes](#)
- [iDRAC Quick Sync 2 indicator codes](#)
- [iDRAC Direct LED indicator codes](#)
- [LCD panel](#)
- [NIC indicator codes](#)
- [Power supply unit indicator codes](#)
- [Drive indicator codes](#)

## Status LED indicators

 **NOTE:** The indicators display solid amber if any error occurs.

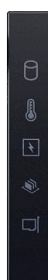







Figure 221. Status LED indicators

Table 120. Status LED indicators and descriptions

Icon	Description	Condition	Corrective action
	Drive indicator	The indicator turns solid amber if there is a drive error.	<ul style="list-style-type: none"> <li>• Check the System Event Log to determine if the drive has an error.</li> <li>• Run the appropriate Online Diagnostics test. Restart the system and run embedded diagnostics (ePSA).</li> <li>• If the drives are configured in a RAID array, restart the system, and enter the host adapter configuration utility program.</li> </ul>
	Temperature indicator	The indicator turns solid amber if the system experiences a thermal error (for example, the ambient temperature is out of range or there is a fan failure).	<p>Ensure that none of the following conditions exist:</p> <ul style="list-style-type: none"> <li>• A cooling fan has been removed or has failed.</li> <li>• System cover, air shroud, or back filler bracket is removed.</li> <li>• Ambient temperature is too high.</li> <li>• External airflow is obstructed.</li> </ul> <p>If the problem persists, see the <a href="#">Getting help</a> section.</p>

**Table 120. Status LED indicators and descriptions (continued)**

Icon	Description	Condition	Corrective action
	Electrical indicator	The indicator turns solid amber if the system experiences an electrical error (for example, voltage out of range, or a failed power supply unit (PSU) or voltage regulator).	Check the System Event Log or system messages for the specific issue. If it is due to a problem with the PSU, check the LED on the PSU. Reseat the PSU.  If the problem persists, see the <a href="#">Getting help</a> section.
	Memory indicator	The indicator turns solid amber if a memory error occurs.	Check the System Event Log or system messages for the location of the failed memory. Reseat the memory module.  If the problem persists, see the <a href="#">Getting help</a> section.
	PCIe indicator	The indicator turns solid amber if a PCIe card experiences an error.	Restart the system. Update any required drivers for the PCIe card. Reinstall the card.  If the problem persists, see the <a href="#">Getting help</a> section.  <b>NOTE:</b> For more information about the supported PCIe cards, see the Expansion card installation guidelines section.

## System health and system ID indicator codes

The system health and system ID indicator is located on the left control panel of the system.



**Figure 222. System health and system ID indicator**

**Table 121. System health and system ID indicator codes**

System health and system ID indicator code	Condition
Solid blue	Indicates that the system is powered on, is healthy, and system ID mode is not active. Press the system health and system ID button to switch to system ID mode.
Blinking blue	Indicates that the system ID mode is active. Press the system health and system ID button to switch to system health mode.
Solid amber	Indicates that the system is in fail-safe mode. If the problem persists, see the <a href="#">Getting help</a> section.
Blinking amber	Indicates that the system is experiencing a fault. Check the System Event Log for specific error messages. For information about the event and error messages generated by the system firmware and agents that monitor system components, go to <a href="http://qrl.dell.com">qrl.dell.com</a> > <b>Look Up</b> > <b>Error Code</b> , type the error code, and then click <b>Look it up</b> .

# iDRAC Quick Sync 2 indicator codes

iDRAC Quick Sync 2 module (optional) is located on the left control panel of the system.



**Table 122. iDRAC Quick Sync 2 indicators and descriptions**

iDRAC Quick Sync 2 indicator code	Condition	Corrective action
Off (default state)	Indicates that the iDRAC Quick Sync 2 feature is powered off. Press the iDRAC Quick Sync 2 button to power on the iDRAC Quick Sync 2 feature.	If the LED fails to power on, reseal the left control panel flex cable and check. If the problem persists, see the <a href="#">Getting help</a> section.
Solid white	Indicates that iDRAC Quick Sync 2 is ready to communicate. Press the iDRAC Quick Sync 2 button to power off.	If the LED fails to power off, restart the system. If the problem persists, see the <a href="#">Getting help</a> section.
Blinks white rapidly	Indicates data transfer activity.	If the indicator continues to blink indefinitely, see the <a href="#">Getting help</a> section.
Blinks white slowly	Indicates that firmware update is in progress.	If the indicator continues to blink indefinitely, see the <a href="#">Getting help</a> section.
Blinks white five times rapidly and then powers off	Indicates that the iDRAC Quick Sync 2 feature is disabled.	Check if iDRAC Quick Sync 2 feature is configured to be disabled by iDRAC. If the problem persists, see the <a href="#">Getting help</a> section. <a href="http://www.dell.com/poweredgemanuals">www.dell.com/poweredgemanuals</a> or <i>Dell OpenManage Server Administrator User's Guide</i> at <a href="https://www.dell.com/openmanagemanuals">https://www.dell.com/openmanagemanuals</a> .
Solid amber	Indicates that the system is in fail-safe mode.	Restart the system. If the problem persists, see the <a href="#">Getting help</a> section.
Blinking amber	Indicates that the iDRAC Quick Sync 2 hardware is not responding properly.	Restart the system. If the problem persists, see the <a href="#">Getting help</a> section.

# iDRAC Direct LED indicator codes

The iDRAC Direct LED indicator lights up to indicate that the port is connected and is being used as a part of the iDRAC subsystem.

You can configure iDRAC Direct by using a USB to micro USB (type AB) cable, which you can connect to your laptop or tablet. Cable length should not exceed 3 feet (0.91 meters). Performance could be affected by cable quality. The following table describes iDRAC Direct activity when the iDRAC Direct port is active:

**Table 123. iDRAC Direct LED indicator codes**

iDRAC Direct LED indicator code	Condition
Solid green for two seconds	Indicates that the laptop or tablet is connected.
Blinking green (on for two seconds and off for two seconds)	Indicates that the laptop or tablet connected is recognized.
Powers off	Indicates that the laptop or tablet is unplugged.

# LCD panel

The LCD panel provides system information, status, and error messages to indicate if the system is functioning correctly or requires attention. The LCD panel is used to configure or view the iDRAC IP address of the system. For information about the event and error messages generated by the system firmware and agents that monitor system components, go to [qrl.dell.com](http://qrl.dell.com) > **Look Up** > **Error Code**, type the error code, and then click **Look it up**.

The LCD panel is available only on the optional front bezel. The optional front bezel is hot pluggable.

The status and conditions of the LCD panel are outlined here:

- The LCD backlight is white during normal operating conditions.
- If there is an issue, the LCD backlight turns amber and displays an error code followed by descriptive text.
  - ⓘ **NOTE:** If the system is connected to a power source and an error is detected, the LCD turns amber regardless of whether the system is powered on or off.
- When the system powers off and there are no errors, the LCD enters the standby mode after five minutes of inactivity. Press any button on the LCD to power it on.
- If the LCD panel stops responding, remove the bezel and reinstall it.
  - If the problem persists, see [Getting help](#).
- The LCD backlight remains off if LCD messaging is powered off using the iDRAC utility, the LCD panel, or other tools.

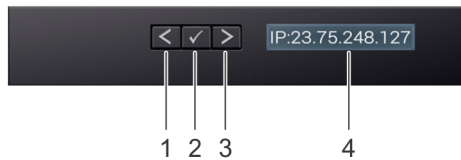


Figure 223. LCD panel features

Table 124. LCD panel features

Item	Button or display	Description
1	Left	Moves the cursor back in one-step increments.
2	Select	Selects the menu item highlighted by the cursor.
3	Right	Moves the cursor forward in one-step increments.  During message scrolling: <ul style="list-style-type: none"> <li>• Press and hold the right button to increase scrolling speed.</li> <li>• Release the button to stop.</li> </ul> ⓘ <b>NOTE:</b> The display stops scrolling when the button is released. After 45 seconds of inactivity, the display starts scrolling.
4	LCD display	Displays the system information, status, and error messages or iDRAC IP address.

## NIC indicator codes

Each NIC on the back of the system has indicators that provide information about the activity and link status. The activity LED indicator indicates if data is flowing through the NIC, and the link LED indicator indicates the speed of the connected network.

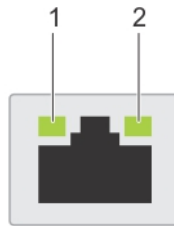


Figure 224. NIC indicator codes

1. Link LED indicator
2. Activity LED indicator

Table 125. NIC indicator codes

NIC indicator codes	Condition
Link and activity indicators are off.	Indicates that the NIC is not connected to the network.
Link indicator is green, and activity indicator is blinking green.	Indicates that the NIC is connected to a valid network at its maximum port speed, and data is being sent or received.
Link indicator is amber, and activity indicator is blinking green.	Indicates that the NIC is connected to a valid network at less than its maximum port speed, and data is being sent or received.
Link indicator is green, and activity indicator is off.	Indicates that the NIC is connected to a valid network at its maximum port speed, and data is not being sent or received.
Link indicator is amber, and activity indicator is off.	Indicates that the NIC is connected to a valid network at less than its maximum port speed, and data is not being sent or received.
Link indicator is blinking green, and activity is off.	Indicates that the NIC identify is enabled through the NIC configuration utility.

## Power supply unit indicator codes

AC and DC power supply units (PSUs) have an illuminated translucent handle that serves as an indicator. The indicator shows if power is present or if a power fault has occurred.

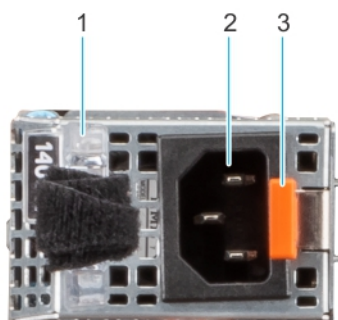


Figure 225. AC PSU status indicator

1. AC PSU handle
2. Socket
3. Release latch

**Table 126. AC and DC PSU status indicator codes**

Power indicator codes	Condition
Green	Indicates that a valid power source is connected to the PSU and the PSU is operational.
Blinking amber	Indicates an issue with the PSU.
Not powered on	Indicates that the power is not connected to the PSU.
Blinking green	Indicates that the firmware of the PSU is being updated. <b>⚠ CAUTION: Do not disconnect the power cord or unplug the PSU when updating firmware. If firmware update is interrupted, the PSUs will not function.</b>
Blinking green and powers off	When hot-plugging a PSU, it blinks green five times at a rate of 4 Hz and powers off. This indicates a PSU mismatch due to efficiency, feature set, health status, or supported voltage. <b>⚠ CAUTION: If two PSUs are installed, both the PSUs must have the same type of label; for example, Extended Power Performance (EPP) label. Mixing PSUs from previous generations of PowerEdge servers is not supported, even if the PSUs have the same power rating. This results in a PSU mismatch condition or failure to power on the system.</b> <b>⚠ CAUTION: If two PSUs are used, they must be of the same type and have the same maximum output power.</b> <b>⚠ CAUTION: When correcting a PSU mismatch, replace the PSU with the blinking indicator. Swapping the PSU to make a matched pair can result in an error condition and an unexpected system shutdown. To change from a high output configuration to a low output configuration or vice versa, you must power off the system.</b> <b>⚠ CAUTION: AC PSUs support both 240 V and 120 V input voltages with the exception of Titanium PSUs, which support only 240 V. When two identical PSUs receive different input voltages, they can output different wattages, and trigger a mismatch.</b>

## Drive indicator codes

The LEDs on the drive carrier indicate the state of each drive. Each drive carrier has two LEDs: an activity LED (green) and a status LED (bicolor, green/amber). The activity LED blinks whenever the drive is accessed.



**Figure 226. Drive indicators**

1. Drive activity LED indicator

- 2. Drive status LED indicator
- 3. Drive capacity label



**Figure 227. Drive indicators**

- 1. Drive activity LED indicator
- 2. Drive status LED indicator
- 3. Drive capacity label

**NOTE:** If the drive is in the Advanced Host Controller Interface (AHCI) mode, the status LED indicator does not power on.

**NOTE:** Drive status indicator behavior is managed by Storage Spaces Direct. Not all drive status indicators may be used.

**Table 127. Drive indicator codes**

Drive status indicator code	Condition
Blinks green twice per second	Indicates that the drive is being identified or preparing for removal.
Not powered on	Indicates that the drive is ready for removal. <b>NOTE:</b> The drive status indicator remains off until all drives are initialized after the system is powered on. Drives are not ready for removal during this time.
Blinks green, amber, and then powers off	Indicates that there is an unexpected drive failure.
Blinks amber four times per second	Indicates that the drive has failed.
Blinks green slowly	Indicates that the drive is rebuilding.
Solid green	Indicates that the drive is online.
Blinks green for three seconds, amber for three seconds, and then powers off after six seconds	Indicates that the rebuild has stopped.


# Using system diagnostics

If you experience an issue with the system, run the system diagnostics before contacting Dell for technical assistance. The purpose of running system diagnostics is to test the system hardware without using additional equipment or risking data loss. If you are unable to fix the issue yourself, service and support personnel can use the diagnostics results to help you solve the issue.

## Topics:

- [Dell Embedded System Diagnostics](#)

## Dell Embedded System Diagnostics

 **NOTE:** The Dell Embedded System Diagnostics is also known as Enhanced Pre-boot System Assessment (ePSA) diagnostics.

The Embedded System Diagnostics provide a set of options for particular device groups or devices allowing you to:

- Run tests automatically or in an interactive mode
- Repeat tests
- Display or save test results
- Run thorough tests to introduce additional test options to provide extra information about the failed device(s)
- View status messages that inform you if tests are completed successfully
- View error messages that inform you of issues encountered during testing

## Running the Embedded System Diagnostics from Boot Manager

Run the Embedded System Diagnostics (ePSA) if your system does not boot.

### Steps

1. When the system is booting, press F11.
2. Use the up arrow and down arrow keys to select **System Utilities > Launch Diagnostics**.
3. Alternatively, when the system is booting, press F10, select **Hardware Diagnostics > Run Hardware Diagnostics**.  
The **ePSA Pre-boot System Assessment** window is displayed, listing all devices detected in the system. The diagnostics starts executing the tests on all the detected devices.

## Running the Embedded System Diagnostics from the Dell Lifecycle Controller

### Steps

1. When the system is booting, press F10.
2. Select **Hardware Diagnostics → Run Hardware Diagnostics**.  
The **ePSA Pre-boot System Assessment** window is displayed, listing all devices detected in the system. The diagnostics start executing the tests on all the detected devices.



## System diagnostic controls

Table 128. System diagnostic controls

Menu	Description
Configuration	Displays the configuration and status information of all detected devices.
Results	Displays the results of all tests that are run.
System health	Provides the current overview of the system performance.
Event log	Displays a time-stamped log of the results of all tests run on the system. This is displayed if at least one event description is recorded.

# System board diagnostic LED indicators

The system board LED indicators provide status of the system when it is powered on, which help identify POST and hardware issues.

For information about the different LED indicator sequences and description, see the interactive **LED pattern decoder tool** -<https://internal.software/blink/>.

## Enhanced Preboot System Assessment

If you experience an issue with the system, run the system diagnostics before contacting Dell for technical assistance. The purpose of running system diagnostics is to test the system hardware without requiring more equipment or risking data loss. If you are unable to fix the issue yourself, service and support personnel can use the diagnostics results to help you solve the issue.

### Dell Embedded system diagnostics

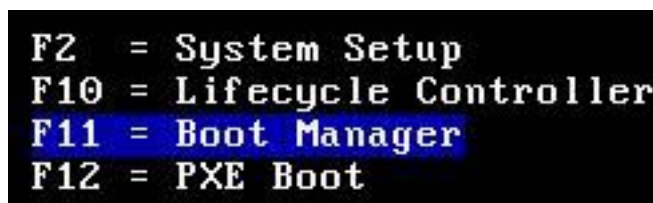
**NOTE:** The Dell Embedded System Diagnostics is also known as Enhanced Preboot System Assessment (ePSA) diagnostics.

The embedded system diagnostics provides a set of options for particular device groups or devices that allow you to:

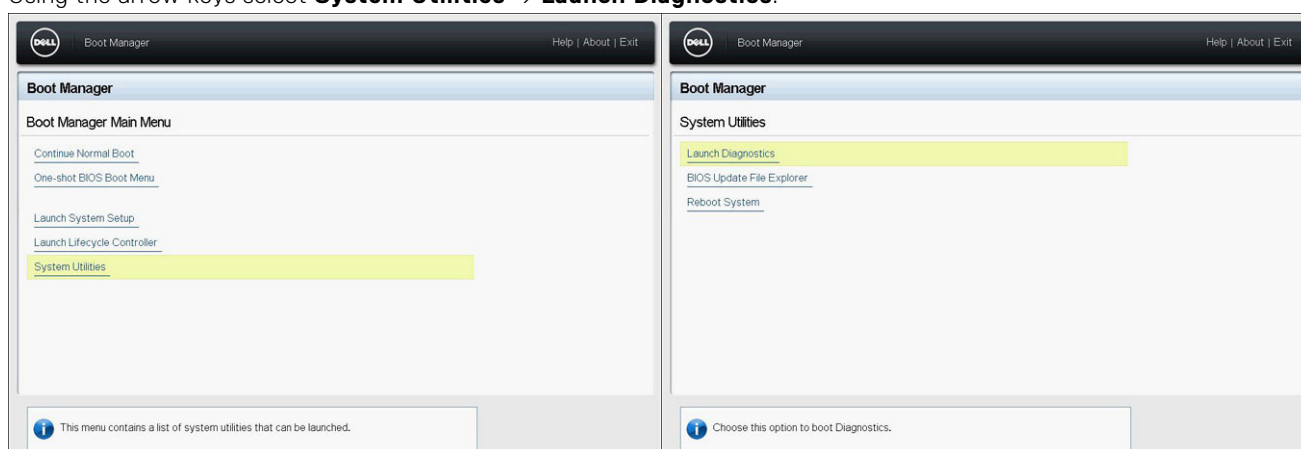
- Run tests automatically or in an interactive mode.
- Repeat tests
- Display or save test results.
- Introduce more test options for extra information about the failed devices, run a thorough test.
- View status messages that inform you if tests are completed successfully.
- View error messages that inform you of issues encountered during testing.

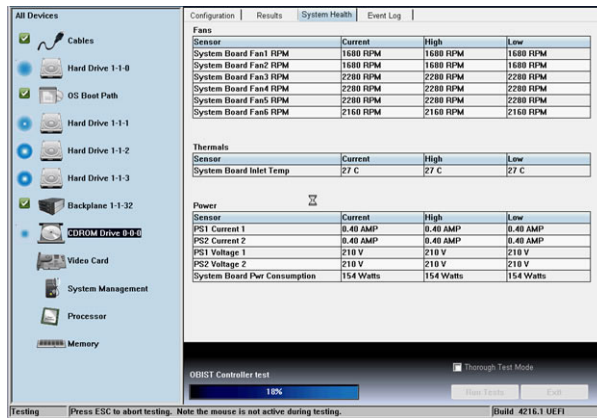
### Running the Embedded system diagnostics from Boot Manager

To run the embedded system diagnostics from Boot Manager:



1. As the system boots, press <F11>.
2. Using the arrow keys select **System Utilities** → **Launch Diagnostics**.

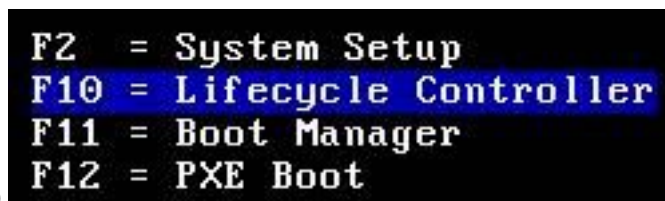




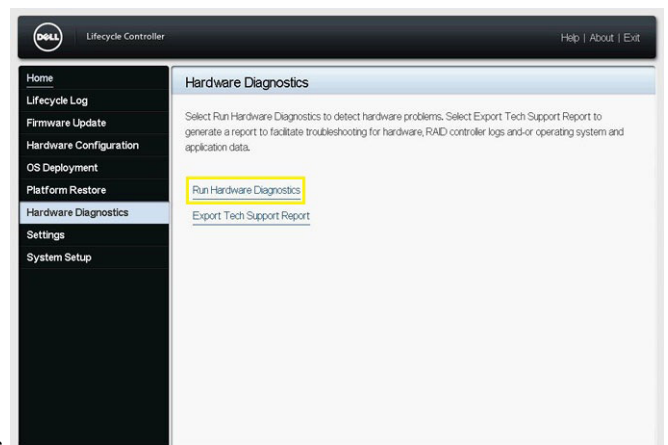
3. Wait while the Quick Tests automatically run.
4. Once the tests have been completed, you can view the results and additional information on the **Results** tab, the **System Health** tab, the **Configuration** tab, and the **Event Log** tab.
5. Close the **Embedded System Diagnostics** utility.
6. To leave the diagnostics, click **Exit**.
7. Click **OK** when prompted, and the system reboots.

## Running the Embedded System Diagnostics from the Dell Lifecycle Controller

To run the embedded system diagnostics from the Dell Lifecycle Controller:



1. As the system boots, press **F10**.



2. Select **Hardware Diagnostics** → **Run Hardware Diagnostics**.

## Getting help

You can download drivers, firmware and documents from the FTP site: <https://mft.dell.com/R7615>. For more information about username and password, contact your TAM (Tech Account Manager).

The QRL, SupportAssist/ Secure Connect Gateway, and eSupport sites will be launched in Quarter 4 of the calendar year 2022.

### Topics:

- [Recycling or End-of-Life service information](#)
- [Contacting Dell Technologies](#)
- [Accessing system information by using QRL](#)

## Recycling or End-of-Life service information

Take back and recycling services are offered for this product in certain countries. If you want to dispose of system components, visit [www.dell.com/recyclingworldwide](http://www.dell.com/recyclingworldwide) and select the relevant country.

## Contacting Dell Technologies

Dell provides online and telephone based support and service options. If you do not have an active internet connection, you can find Dell contact information on your purchase invoice, packing slip, bill or Dell product catalog. The availability of services varies depending on the country and product, and some services may not be available in your area. To contact Dell for sales, technical assistance, or customer service issues follow these steps:

### Steps

1. Go to [www.dell.com/support/home](http://www.dell.com/support/home).
2. Select your country from the drop-down menu on the lower right corner of the page.
3. For customized support:
  - a. Enter the system Service Tag in the **Enter a Service Tag, Serial Number, Service Request, Model, or Keyword** field.
  - b. Click **Search**.  
The support page that lists the various support categories is displayed.
4. For general support:
  - a. Select your product category.
  - b. Select your product segment.
  - c. Select your product.  
The support page that lists the various support categories is displayed.
5. For contact details of Dell Global Technical Support:
  - a. Click [Contact Technical Support](#).
  - b. The **Contact Technical Support** page is displayed with details to call, chat, or e-mail the Dell Global Technical Support team.

## Accessing system information by using QRL

There is also another QRL for accessing product information located on the back of the system cover.

### Prerequisites

Ensure that your smartphone or tablet has a QR code scanner installed.

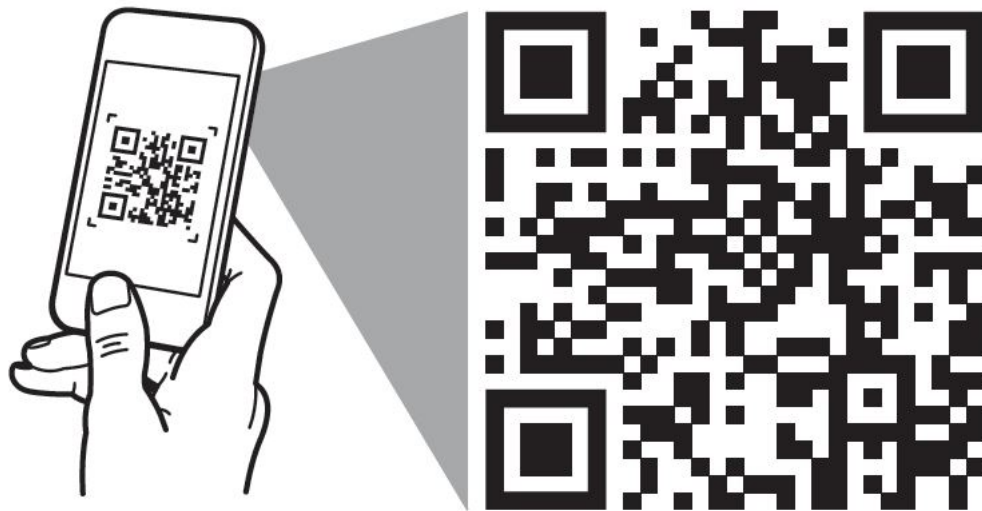
The QRL includes the following information about your system:

- How-to videos
- Reference materials, including the Installation and Service Manual, and mechanical overview
- The system service tag to quickly access the specific hardware configuration and warranty information
- A direct link to Dell to contact technical assistance and sales teams

#### Steps

1. Go to [www.dell.com/qrl](http://www.dell.com/qrl), and navigate to your specific product or
2. Use your smart phone or tablet to scan the model-specific Quick Resource (QR) code on your system or in the Quick Resource Locator section.

## Quick Resource Locator for PowerEdge R7615 system



# Quick Resource Locator

[Dell.com/QRL/Server/PER7615](http://Dell.com/QRL/Server/PER7615)

Figure 228. Quick Resource Locator for PowerEdge R7615 system

## Receiving automated support with SupportAssist

Dell SupportAssist is an optional Dell Services offering that automates technical support for your Dell server, storage, and networking devices. By installing and setting up a SupportAssist application in your IT environment, you can receive the following benefits:


- Automated issue detection — SupportAssist monitors your Dell devices and automatically detects hardware issues, both proactively and predictively.
- Automated case creation — When an issue is detected, SupportAssist automatically opens a support case with Dell Technical Support.
- Automated diagnostic collection — SupportAssist automatically collects system state information from your devices and uploads it securely to Dell. This information is used by Dell Technical Support to troubleshoot the issue.
- Proactive contact — A Dell Technical Support agent contacts you about the support case and helps you resolve the issue.

The available benefits vary depending on the Dell Service entitlement purchased for your device. For more information about SupportAssist, go to [www.dell.com/supportassist](http://www.dell.com/supportassist).

## Documentation resources

This section provides information about the documentation resources for your system.

To view the document that is listed in the documentation resources table:

- From the Dell support site:
  1. Click the documentation link that is provided in the Location column in the table.
  2. Click the required product or product version.
-  **NOTE:** To locate the model number, see the front of your system.
- 3. On the Product Support page, click **Documentation**.
- Using search engines:
  - Type the name and version of the document in the search box.

**Table 129. Additional documentation resources for your system**

Task	Document	Location
Setting up your system	<p>For more information about installing and securing the system into a rack, see the Rail Installation Guide included with your rail solution.</p> <p>For information about setting up your system, see the <i>Getting Started Guide</i> document that is shipped with your system.</p>	<a href="http://www.dell.com/poweredgemanuals">www.dell.com/poweredgemanuals</a>
Configuring your system	<p>For information about the iDRAC features, configuring and logging in to iDRAC, and managing your system remotely, see the Integrated Dell Remote Access Controller User's Guide.</p> <p>For information about understanding Remote Access Controller Admin (RACADM) subcommands and supported RACADM interfaces, see the RACADM CLI Guide for iDRAC.</p> <p>For information about Redfish and its protocol, supported schema, and Redfish Eventing implemented in iDRAC, see the Redfish API Guide.</p> <p>For information about iDRAC property database group and object descriptions, see the Attribute Registry Guide.</p> <p>For information about Intel QuickAssist Technology, see the Integrated Dell Remote Access Controller User's Guide.</p>	<a href="http://www.dell.com/poweredgemanuals">www.dell.com/poweredgemanuals</a>
	<p>For information about earlier versions of the iDRAC documents.</p> <p>To identify the version of iDRAC available on your system, on the iDRAC web interface, click <b>? &gt; About</b>.</p>	<a href="http://www.dell.com/idracmanuals">www.dell.com/idracmanuals</a>



**Table 129. Additional documentation resources for your system (continued)**

Task	Document	Location
	For information about installing the operating system, see the operating system documentation.	<a href="http://www.dell.com/operatingsystemmanuals">www.dell.com/operatingsystemmanuals</a>
	For information about updating drivers and firmware, see the Methods to download firmware and drivers section in this document.	<a href="http://www.dell.com/support/drivers">www.dell.com/support/drivers</a>
Managing your system	For information about systems management software offered by Dell, see the Dell OpenManage Systems Management Overview Guide.	<a href="http://www.dell.com/poweredgemanuals">www.dell.com/poweredgemanuals</a>
	For information about setting up, using, and troubleshooting OpenManage, see the Dell OpenManage Server Administrator User's Guide.	<a href="http://www.dell.com/openmanagemanuals">www.dell.com/openmanagemanuals</a> > OpenManage Server Administrator
	For information about installing and using Dell SupportAssist, see the Dell SupportAssist Enterprise User's Guide.	<a href="https://www.dell.com/serviceabilitytools">https://www.dell.com/serviceabilitytools</a>
	For information about partner programs enterprise systems management, see the OpenManage Connections Enterprise Systems Management documents.	<a href="http://www.dell.com/openmanagemanuals">www.dell.com/openmanagemanuals</a>
Working with the Dell PowerEdge RAID controllers	For information about understanding the features of the Dell PowerEdge RAID controllers (PERC), Software RAID controllers, or BOSS card and deploying the cards, see the Storage controller documentation.	<a href="http://www.dell.com/storagecontrollermanuals">www.dell.com/storagecontrollermanuals</a>
Understanding event and error messages	For information about the event and error messages generated by the system firmware and agents that monitor system components, go to <a href="http://qrl.dell.com">qrl.dell.com</a> > <b>Look Up</b> > <b>Error Code</b> , type the error code, and then click <b>Look it up</b> .	<a href="http://www.dell.com/qrl">www.dell.com/qrl</a>
Troubleshooting your system	For information about identifying and troubleshooting the PowerEdge server issues, see the Server Troubleshooting Guide.	<a href="http://www.dell.com/poweredgemanuals">www.dell.com/poweredgemanuals</a>